



DC UNIVERSE™
**SUPER
HEROES**



30160



6004851

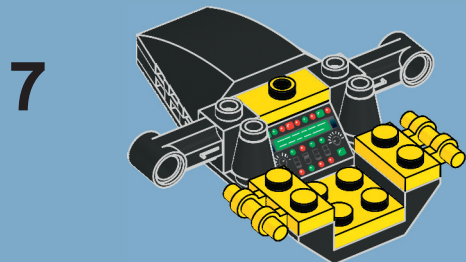
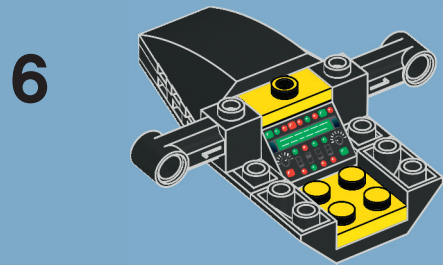
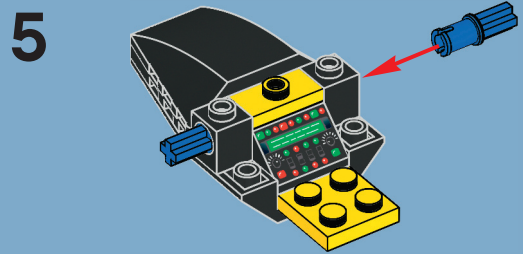
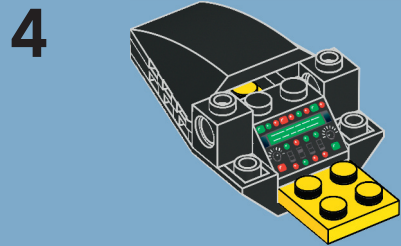
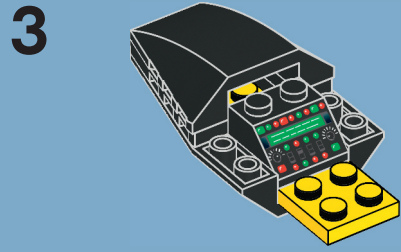
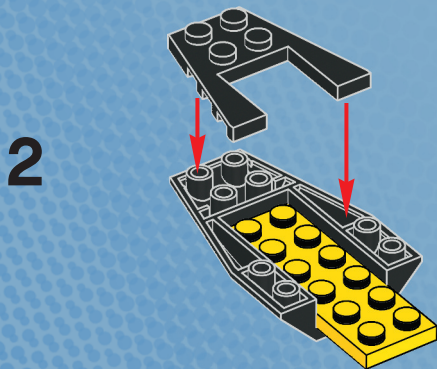
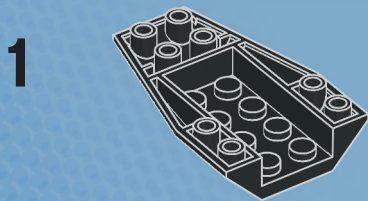
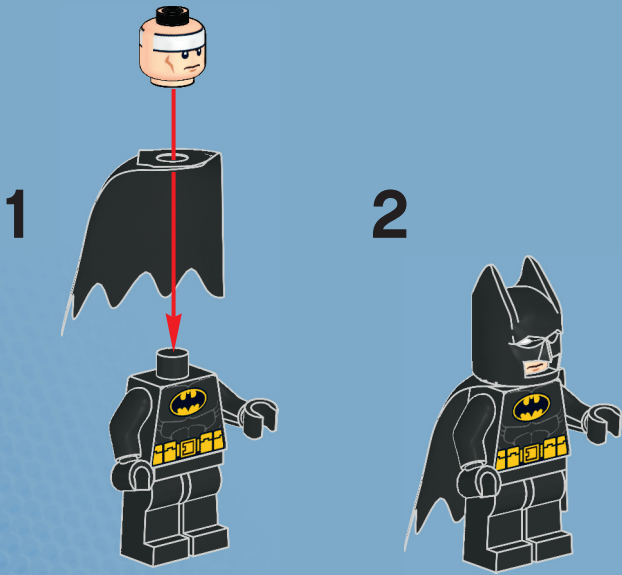

8

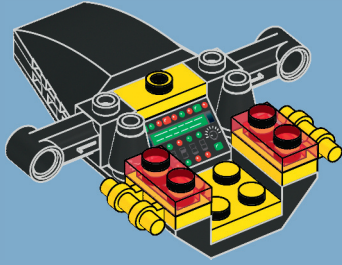

9

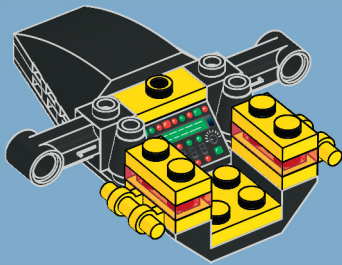

10

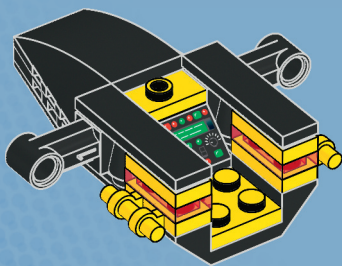

11

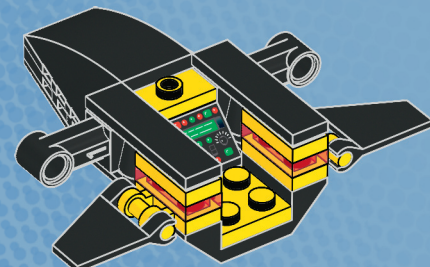

12

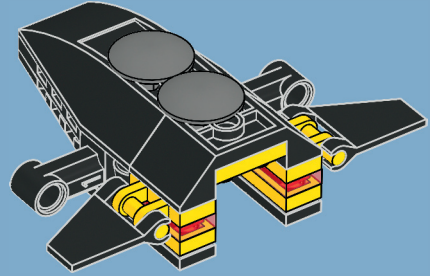

13

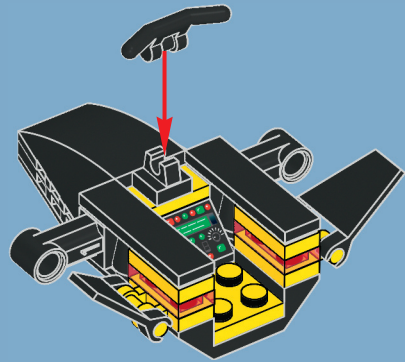

1

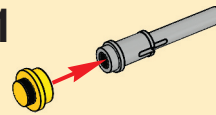

2

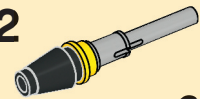

2x



14

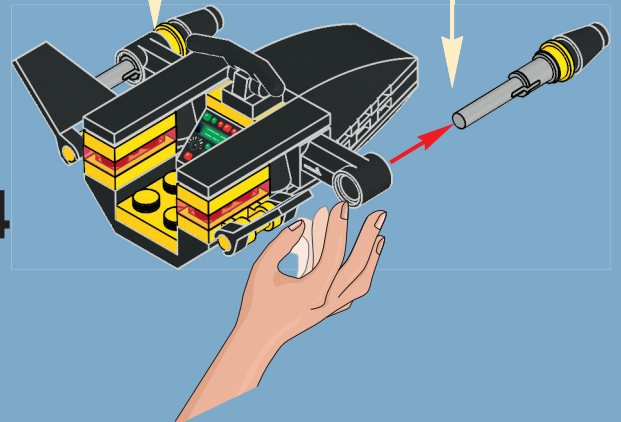

LEGO and the LEGO logo are trademarks of the LEGO Group.
©2012 The LEGO Group.

DC TM & © DC Comics.

WB SHIELD: TM & © Warner Bros. Entertainment Inc.
(s12)

 www.LEGO.com

6004851