



**University of Idaho**

College of Engineering

# **UI CAMPUS MICROGRID EXPANSION SENIOR DESIGN**

**“THE FACILITATORS”**

**SHAUN ANDREWS, SHAWN NAUGHTON,  
CHRISTOPHER CERVINO, ZIYU QIAN, HUIYU  
ZHAO**



# VALUE PROPOSITION

Our analysis will reveal pertinent issues associated with the expansion of the microgrid and will expose the pros and cons pertaining to the capacity, connectivity, protection, and overall efficiency of the grid. We will also highlight the best suited technology for these applications.

# PROJECT GOAL

- I Expand the current campus microgrid design to integrate the new solar generation from the 1 MW array, the IRIC array, as well as the critical load of the wells.
- I Relays, switches, and controls will be tactfully integrated to ensure effective grid diagnostics and controllability. (Islanding/Load Shedding)
- I Determine which loads can be supported given available generation and under specific use case scenarios.
- I Account for seasonal changes and their effects on energy efficiency.





# AVAILABLE GENERATION



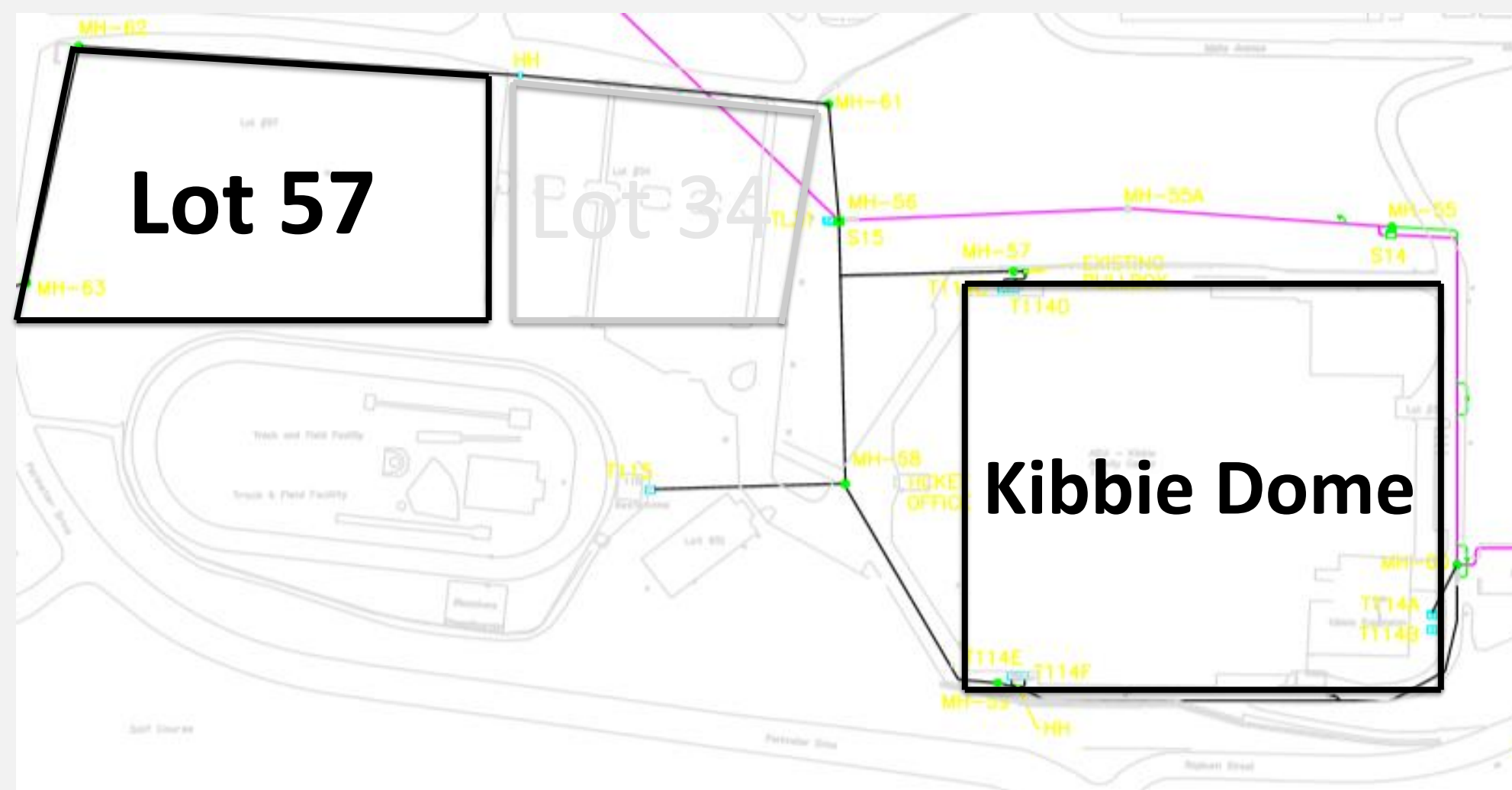

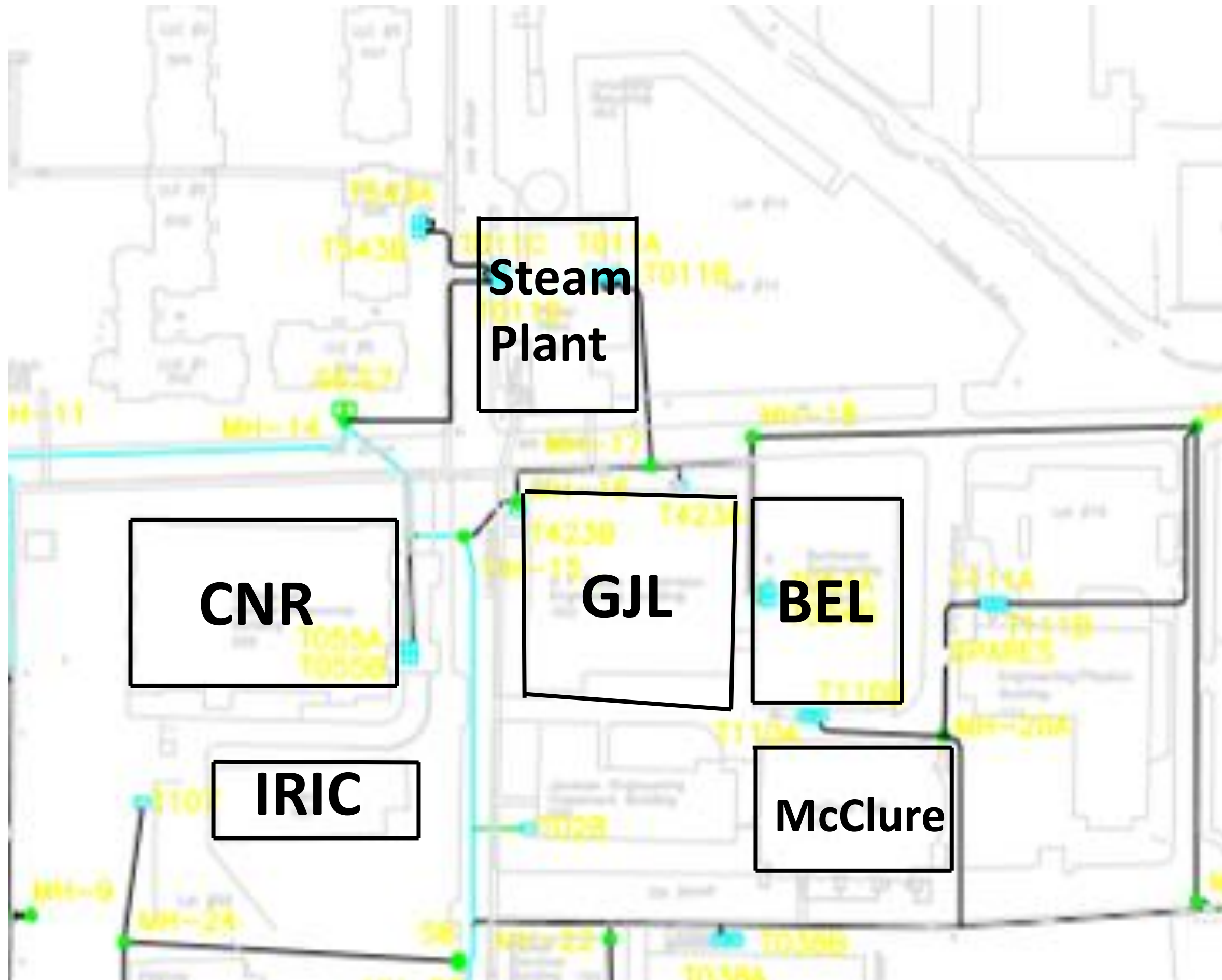

- I UI Steam Plant Turbines
- I IRIC Solar Array
- I Solar Backup Power Array
- I Backup Generators







# LOADS

-  Buchanan Engineering Lab
-  Gauss-Johnson Engineering Lab
-  College of Natural Resources
-  McClure
-  Steam Plant
-  Wells
-  IRIC

# DESIGN APPROACH

Simulate the expanded microgrid using PowerWorld:

- Power flow analysis
- Load shedding
- N-1 Contingency analysis (What if scenarios)
- Fault analysis
- Seasonal analysis
- Optimize equipment allocation

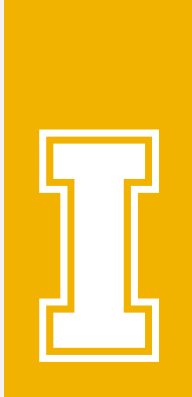

# POWERWORLD

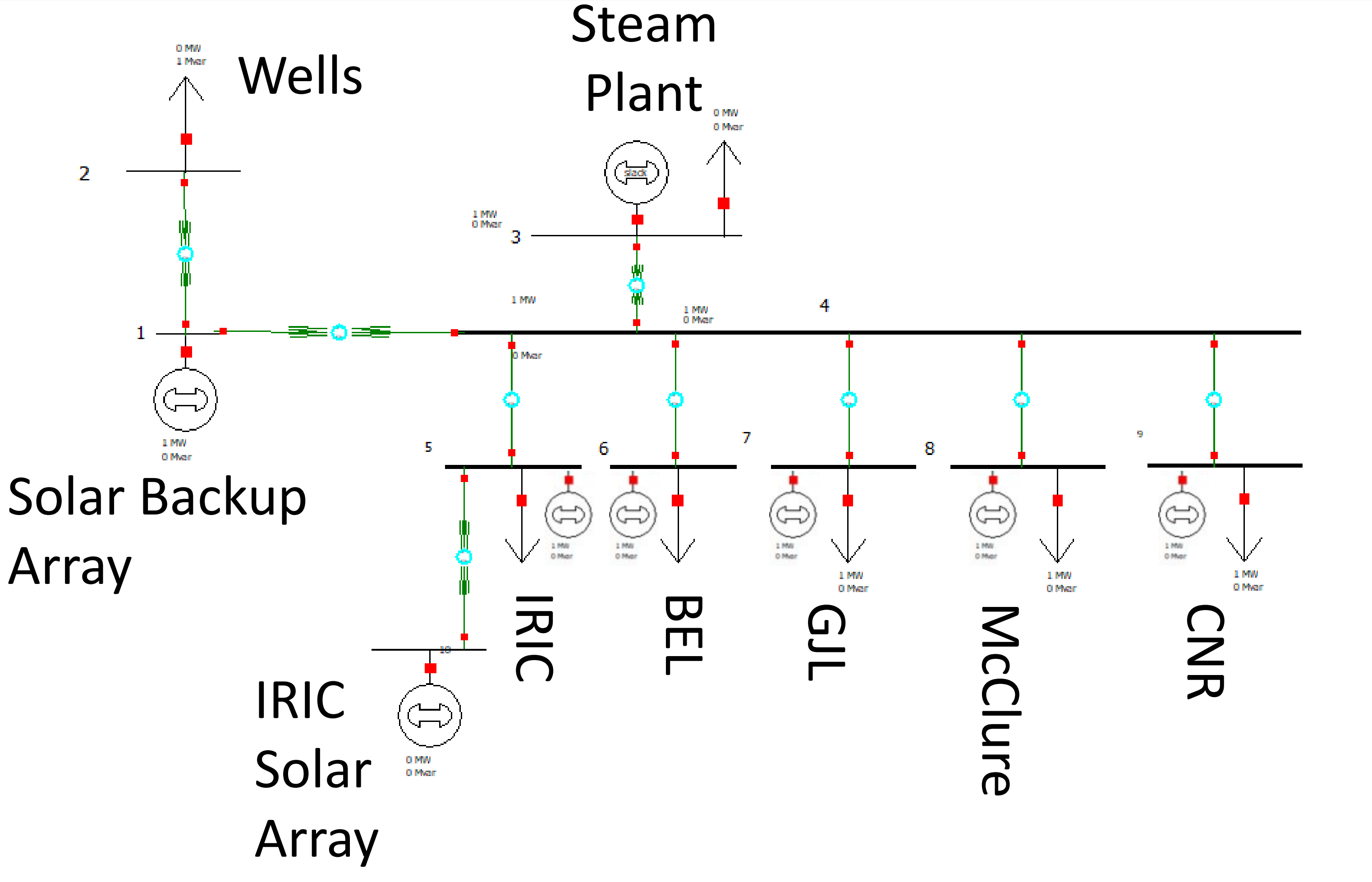

# USE CASES

- Worst case scenario
  - All generation must be diverted to supplying the load of the wells.
- Steady-state operation
  - Available generation may be used to support critical load buildings. This steady state operation includes load shedding due to undervoltages.



# TESTING AND DELIVERABLES

- PowerWorld modular simulation.
- Analysis of Seasonal (monthly) effects on available generation from all sources as well as daytime vs. nighttime.
- Economic Analysis
  - Suggested addition of more SEL 751 relays and remote breakers
  - Cost/benefit analysis



# BUDGET

Electrical Item	Cost P.U.	Qty.	Total				Total Cost:	\$ 43,170.00
SEL-3555 (RTAC)	\$ 7,195.00	6	\$ 43,170.00					
2 AWG Cable	\$ 1.29	0	\$ -				Total Cost w/ Risk Insurance	\$ 431.70
1 in 40 conduit	\$ 4.15	0	\$ -					
1 in 80 conduit	\$ 6.54	0	\$ -				Total Cost w/ Tax:	\$ 46,191.90
2 in 40 conduit	\$ 8.31	0	\$ -					
2 in 80 conduit	\$ 15.70	0	\$ -				Total Cost w/ Tax and w/ 15%	\$ 53,120.69
Labor	\$ 150.00	0	\$ -					
							Total Cost during project:	\$ -
							(due to donations)	
Landscaping Item	Cost P.U.	Qty.	Total					
Mulch	\$ 49.68	0	\$ -					
Plants	\$ 12.98	0	\$ -					
Trees	\$ 75.38	0	\$ -					
Labor	\$ 57.50	0	\$ -					



# BUDGET CONT.

Landscaping Item	Cost P.U.	Qty.	Total
Mulch	\$ 49.68	0	\$ -
Plants	\$ 12.98	0	\$ -
Trees	\$ 75.38	0	\$ -
Labor	\$ 57.50	0	\$ -
Asphalt Item	Cost P.U.	Qty.	Total
Disposal	\$ 22.50	0	\$ -
Asphalt	\$ 33.75	0	\$ -
Equipment	\$ 275.00	0	\$ -
Labor	\$ 72.45	0	\$ -
Concrete Item	Cost P.U.	Qty.	Total
Disposal	\$ 36.80	0	\$ -
Rebar	\$ 3.28	0	\$ -
Concrete	\$ 113.00	0	\$ -
Equipment	\$ 65.00	0	\$ -
Labor	\$ 57.50	0	\$ -





## Microgrid Expansion





**University** *of* **Idaho**

College of Engineering

**QUESTIONS?**