

The Entropy Police

Geothermal heat pump design program

Contact: enr-entropy@uidaho.edu

Colin Ryan
Mitchel Gogert
Samuel Qualls
Desiree Reed

Lead Instructor: Dr. Tao Xing

Problem Statement

Geothermal heat pumps are a complex systems that are difficult to design, analyze and optimize. The use of thermal analysis programs can ease this design process. An application for this process is not currently available.

Objectives

To design a program in Engineering Equation Solver (EES) that:

- Analyzes a geothermal system
- Utilizes engineering economics to optimize pipe dimensions and flow
- Has a simple user interface to allow easy design modifications

EES

- EES allows convenient analysis with built in thermodynamic properties.
- Performs unit analysis
- Create user interface

"SOLUTION:"

"Performance Model"

$$\dot{Q} = \dot{m}_h c_p (T_{h,in} - T_{h,out})$$

$$\dot{Q} = \dot{m}_c c_p (t_{c,out} - t_{c,in})$$

$$\dot{Q} = UA \cdot \text{LMTD}$$

$$\text{DELTA}T_{out} = \text{DELTA}T_{in} \cdot \exp((\text{DELTA}T_{out} - \text{DELTA}T_{in}) / \text{LMTD})$$

"Flow rate relationships"

"NOTE: The mass flow rate is evaluated at the inlet density of each fluid because the density of each fluid changes as it flows through the heat exchanger. Volumetric flow is NOT conserved ... mass flow IS conserved!"

$$\dot{m}_{dot_h} = \rho_{h,in} \cdot V_{dot_h} \cdot \text{convert}(\text{gpm}, \text{ft}^3 / \text{hr})$$

$$\dot{m}_{dot_c} = \rho_{c,in} \cdot V_{dot_c} \cdot \text{convert}(\text{gpm}, \text{ft}^3 / \text{hr})$$

"Parallel Flow HX"

$$\text{DELTA}T_{in} = T_{h,in} - t_{c,in}$$

$$\text{DELTA}T_{out} = T_{h,out} - t_{c,out}$$

"Counter Flow HX"

$$\text{DELTA}T_{in} = T_{h,in} - t_{c,out}$$

$$\text{DELTA}T_{out} = T_{h,out} - t_{c,in}$$

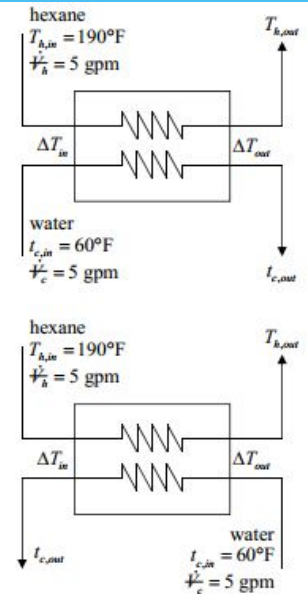

Parallel Flow HX

$$\dot{Q} = 72961 \text{ [Btu/hr]} \quad \text{Heat transfer rate between the fluids}$$

$$T_{h,in} = 190 \text{ [F]} \quad \text{Hot fluid inlet temperature}$$

$$T_{h,out} = 103.7 \text{ [F]} \quad \text{Hot fluid outlet temperature}$$

$$t_{c,in} = 60 \text{ [F]} \quad \text{Cold fluid inlet temperature}$$

$$t_{c,out} = 89.2 \text{ [F]} \quad \text{Cold fluid outlet temperature}$$

$$\text{LMTD} = 52.68 \text{ [R]} \quad \text{LMTD for the heat exchanger}$$

Counter Flow HX

$$\dot{Q} = 82015 \text{ [Btu/hr]}$$

$$T_{h,in} = 190 \text{ [F]}$$

$$T_{h,out} = 92.73 \text{ [F]}$$

$$t_{c,in} = 60 \text{ [F]}$$

$$t_{c,out} = 92.83 \text{ [F]}$$

$$\text{LMTD} = 59.22 \text{ [R]}$$

Heating Load

$$\Delta T = 69 \text{ }^{\circ}\text{F}$$

$$\text{Wall area} = 35,018 \text{ ft}^2$$

$$\text{Roof area} = 18,880 \text{ ft}^2$$

$$\text{Window area} = 4700 \text{ ft}^2$$

To find the heat loss the following equation was used for each unique portion of the building.

$$\text{Heat loss} = (U)(A)(\Delta T)$$

where U is the overall heat transfer coefficient, A is the surface area, and T is the difference in temperature.

$$\text{Max heating load}_{\text{hand calc}} = 594 \text{ kBtu/hr}$$

Geothermal System

Components

1. Heat Exchangers
2. Pump/Compressor
3. Pipes and Fittings
4. Valves
5. Working Fluid

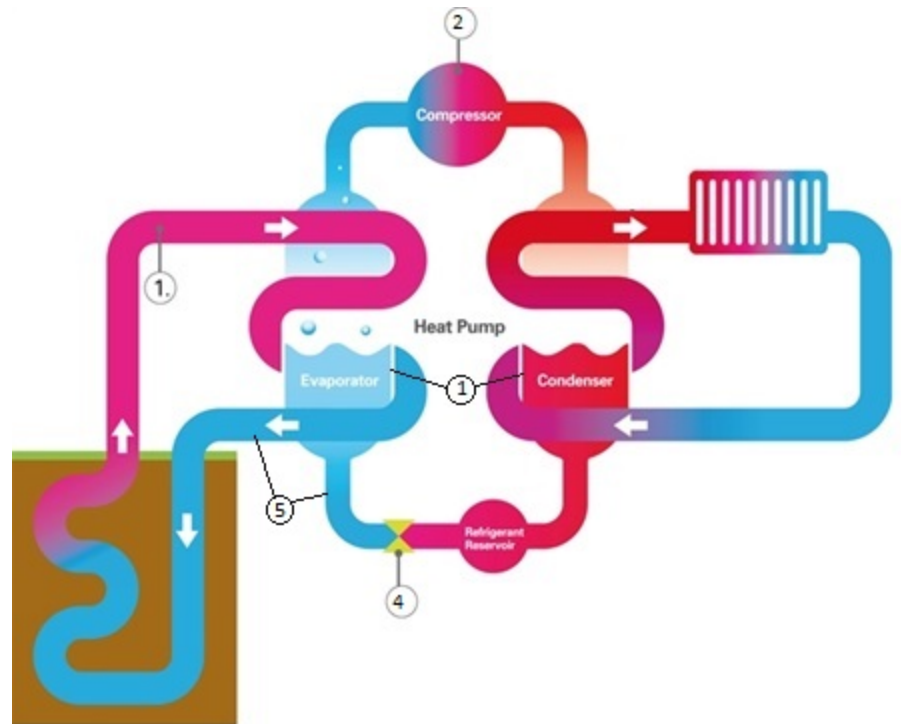

Pump/Compressor

- Needs to overcome system losses (pipe flow, bends, valves)

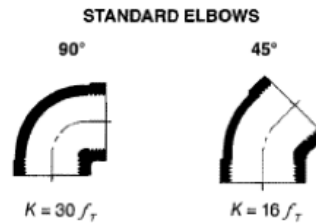

- Pump curves
 - Operating level of pump
- System curve
 - Operating level of system

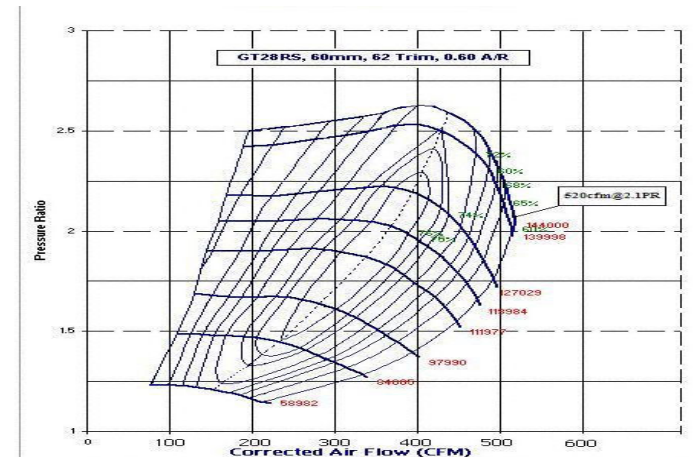
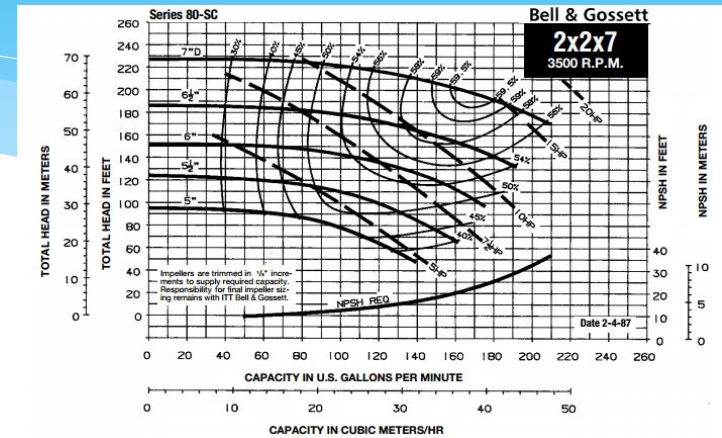

Heat Exchanger

- Types
 - Shell & Tube
 - Double-Pipe
 - Plate and Frame
- Uses
 - Evaporator
 - Condenser

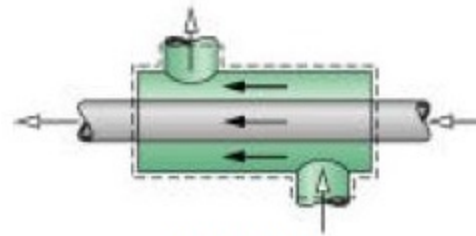
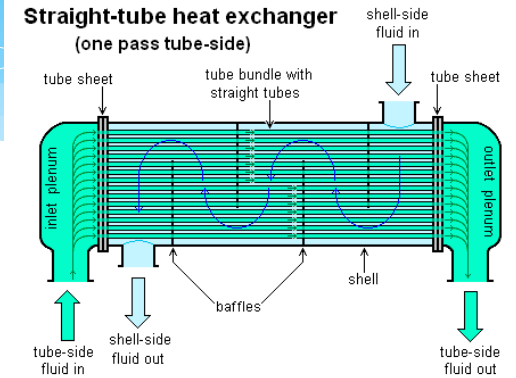

Double-Pipe

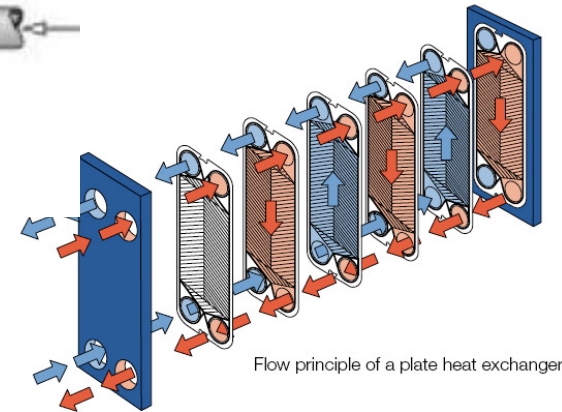

Information Request

- Size requirements (Heat exchanger and pumps)
- Output temperature range
- Geothermal/boiler combined system
- Spirit Center validation data

Time Line

- February 28 – Model individual components
- March 12 – Integrate components into a system
- March 22 – Evaluate heat exchanger types
- April 1 – System model validation
- April 12 – Optimized system design
- April 24 – Final presentation and report
- April 25 – Expo poster
- May 2 – Design Expo