

Project 29

Testbed for Measurement and Control of Generator Power Oscillations



Team name: Shockwave

Team member: Zuhao Zhou
Quan Yan
Changyao Xu
Yutong Chen

Sponsor: The logo for Schweitzer Engineering Laboratories (SEL) is displayed. It consists of a dark blue rectangular background. On the left side, the letters 'SEL' are written in a white, bold, sans-serif font, enclosed within a white rounded rectangular border. To the right of this border, the words 'SCHWEITZER ENGINEERING LABORATORIES' are stacked vertically in a smaller, white, all-caps, sans-serif font.

Client: Matchyaraju Alla



Objective

Building on the data acquisition system designed by a 2018-2019 senior design team design a test bed and test plan for testing generator performance during power swings, especially those near boundary of pole slipping

- (1) Learn to use the present data acquisition system, and in light of the project needs propose, design and implement modifications as needed**
- (2) Develop, test and implement test procedure for safely operating the generator in the appropriate operating conditions.**
- (3) Integrate data from all measurement devices used in a time stamped and synchronized format for post processing**
- (4) Documentation.**



Design Considerations

Material of Testbed board

Polyvinyl chloride

Pros:

- 1) Cheap
- 2) Non-conductive
- 3) Environmentally friendly
- 4) Easy to cut

Cons:

- 1) Low heat resistance



PVC (Polyvinyl Chloride) Sheet, Opaque White, Standard Tolerance, UL 94/ASTM D1784, 3/16" Thickness, 12" Width, 24" Length

by Small Parts

★★★★☆ 83 ratings | 40 answered questions

Best Deal

Price: \$16.10 & FREE Returns

W. Best price W.+

Item Thickness String: 1/2 Inches

1/2 Inches 1/4 Inches 3/16 Inches 3/4 Inches 3/8 Inches

Item Width String: 12 Inches

Item Length String: 24 Inches

12 Inches 24 Inches

Number of Items: 1

- PVC offers an excellent balance of strength and weight, and is typically resistant to acids, alkalis, and most other inorganic chemicals
- Color is opaque white
- Meets UL 94 and ASTM D1784 specifications
- Standard tolerance



Electronic wire



AWG	Diameter		Turns of wire, without insulation		Area		Copper wire										
							Resistance/length ^[7]		Ampacity, ^[8] at 20 °C insulation material temperature rating, or for single unbundled wires in equipment for 16 AWG and smaller ^[9]			Fusing current ^{[10][11]}					
	(in)	(mm)	(per in)	(per cm)	(kcmil)	(mm ²)			(mΩ/m ^[8])	(mΩ/ft ^[6])	60 °C	75 °C	90 °C	Preece ^{[12][13][14][15]}			Onderdonk ^{[16][15]}
							(A)				~10 s	1 s	32 ms				
16	0.0508	1.291	19.7	7.75	2.58	1.31	13.17	4.016			18	117 A	398 A	2.2 kA			
17	0.0453	1.150	22.1	8.70	2.05	1.04	16.61	5.064				99 A	316 A	1.8 kA			
18	0.0403	1.024	24.8	9.77	1.62	0.823	20.95	6.385	10	14	16	83 A	250 A	1.4 kA			
19	0.0359	0.912	27.9	11.0	1.29	0.653	26.42	8.051	—	—	—	70 A	198 A	1.1 kA			
20	0.0320	0.812	31.3	12.3	1.02	0.518	33.31	10.15	5	11	—	58.5 A	158 A	882 A			
21	0.0285	0.723	35.1	13.8	0.810	0.410	42.00	12.80	—	—	—	49 A	125 A	700 A			
22	0.0253	0.644	39.5	15.5	0.642	0.326	52.96	16.14	3	7	—	41 A	99 A	551 A			

- Voltage Rating: 300 Volts ,Rated temperature: 0 C - 80 C
- Material : PVC , Tinning Copper;
- Wire Length:17 meter(55ft) each color
- Color:Red+Blue+Black



Banana Plug

	Technical Data Sheet
	Model 1825, 4897, 4899, 6545 CE Standard Banana Plug, Solderless and Stackable

We use the same brand standard banana plug as the power lab for future replacement and use.

Features

- Designed to fit on the end of any 22 AWG to 18 AWG wire.
- Cross hole wire entry fits wires up to .12" (3mm) diameter.
- Available with tarnish resistant nickel or gold plating for very low contact resistance.
- Model 4899 is rated to temperatures up to +302°F (+150°C).
- Set screw simplifies assembly of test leads and jumpers by using a flat blade screwdriver.
- Fits standard panel and binding post banana jacks .161" to .166" (4,0mm to 4,2mm) diameter.

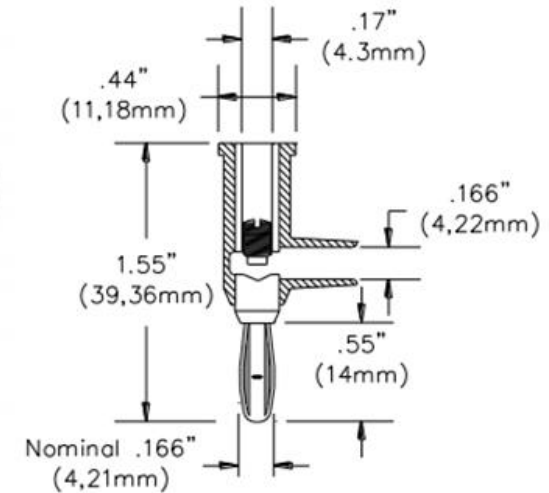

Materials

Banana Jack: Zinc Die Cast, Nickel Plated (Model 4897 is Gold Plated)
 Banana Plug: *Body* – Zinc Die Cast, Nickel Plated (Model 4897 is Gold Plated)
Spring – Beryllium Copper, Nickel Plated (Model 4897 Gold Plated)
 Insulation: Polypropylene (Model 4899 is Polyphenylene Sulfide)
 Set Screw: Steel, Zinc Plated, 8-32 Single Slot



Female Banana Plug

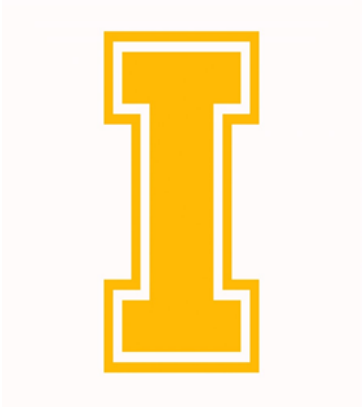
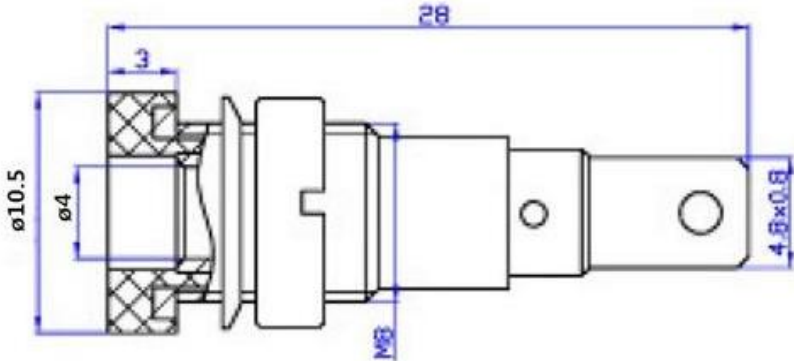

Terminal Strip

The terminals easily can be re-used in the field, allowing for the replacement of wires or equipment, generally with standard hand tools. Screw terminals usually avoid the requirement for a specialized mating connector to be applied to the ends of wires.

We could buy some jumpers if needed.



Connectors

1) Fork Connectors

Red

Wire range: 0.5~1.5mm²
A.W.G.:22~16
Max.current = 19A



Blue

Wire range: 1.5~2.5mm²
A.W.G.:16~14
Max.current = 27A



Yellow

Wire range: 4~6mm²
A.W.G.:12~10
Max.current = 48A



SIZE & QUANTITY

Note: All dimensions are measured manually, there may be measurement errors, please don't mind

2) Alligator Clips

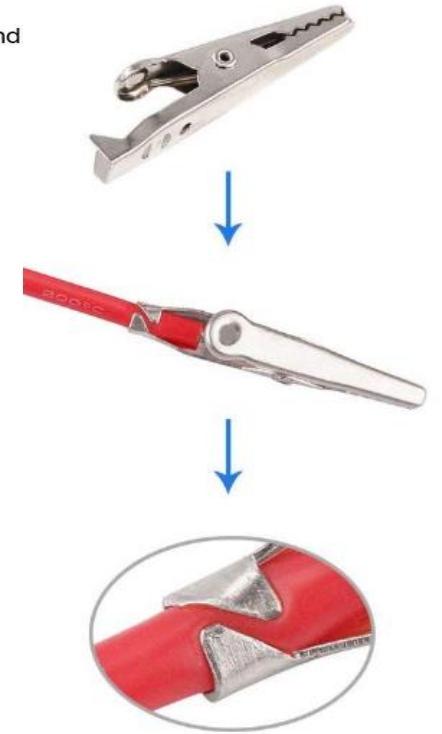
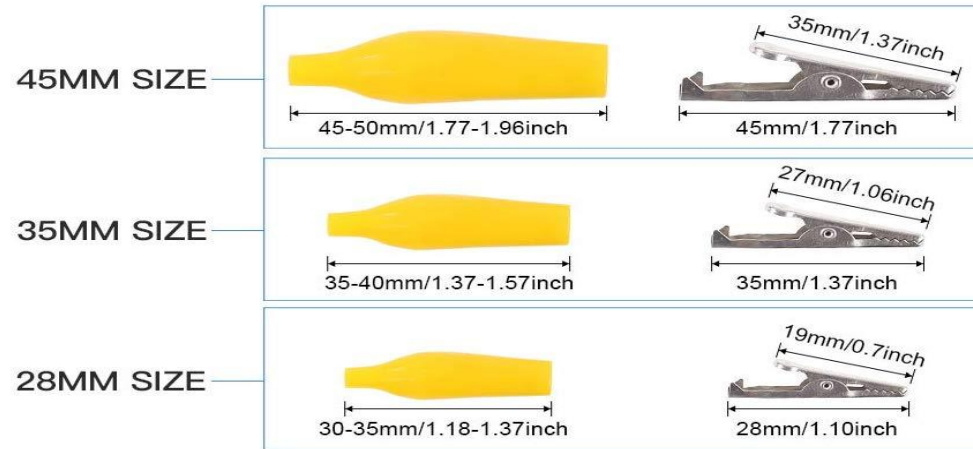

Reasons that we do not use hook connectors

1) Its shape is difficult to fit a flat PVC board

2) More troublesome to install



★ **EASY TO INSTALL**

Used as miniature clamps to hold parts together for gluing and wires together for soldering



Brass Adapter

- 1) Index number
- 2) The sample

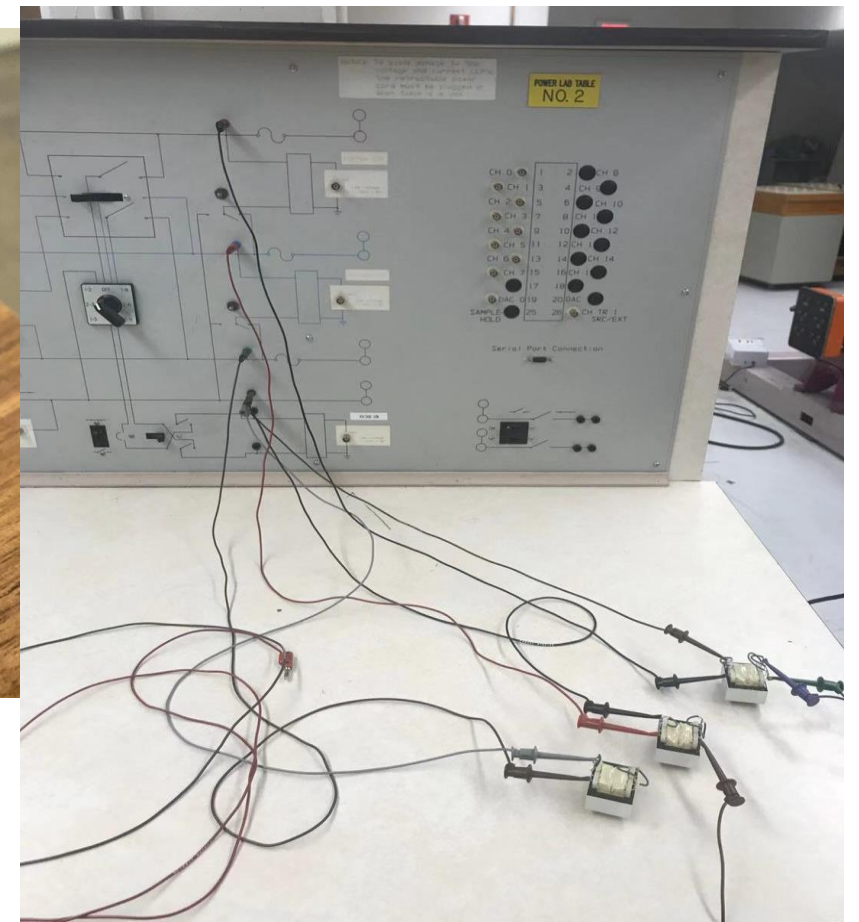

Capstone Design

Combined BOM and Manufacturing Plan - Template

Indented Bill of Materials (BOM)			Manufacturing Plan						Cost		
Part No. or Assy No.	Description	Quantity	Make or Buy?	Source (or Fabrication Location)	Fabrication Technique (if appl.)	Is the Drawing Avail.?	Is the Material Avail.?	Who will lead (Name)?	Target Completion Date	Unit Cost (\$)	Extended Cost (\$)
Full Assy 1											\$ -
Part 1	C type adapter	2	make	ME Worksho		yes	Brass	Bill Magnie	12/03/2020	\$ 90.00	\$ 180.00
Part 2											\$ -



Solid Model –Plan A

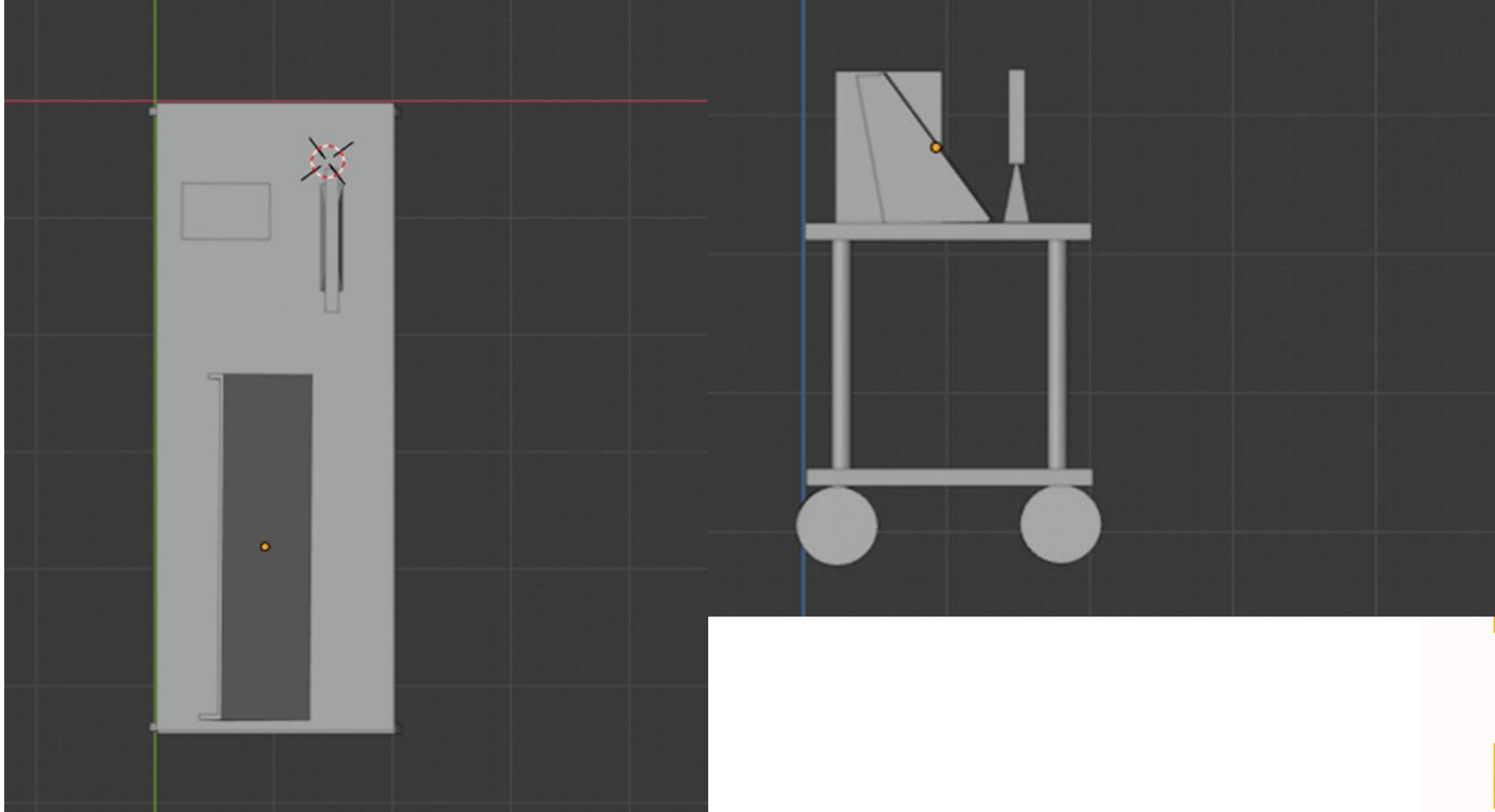

Solid Model –Plan A

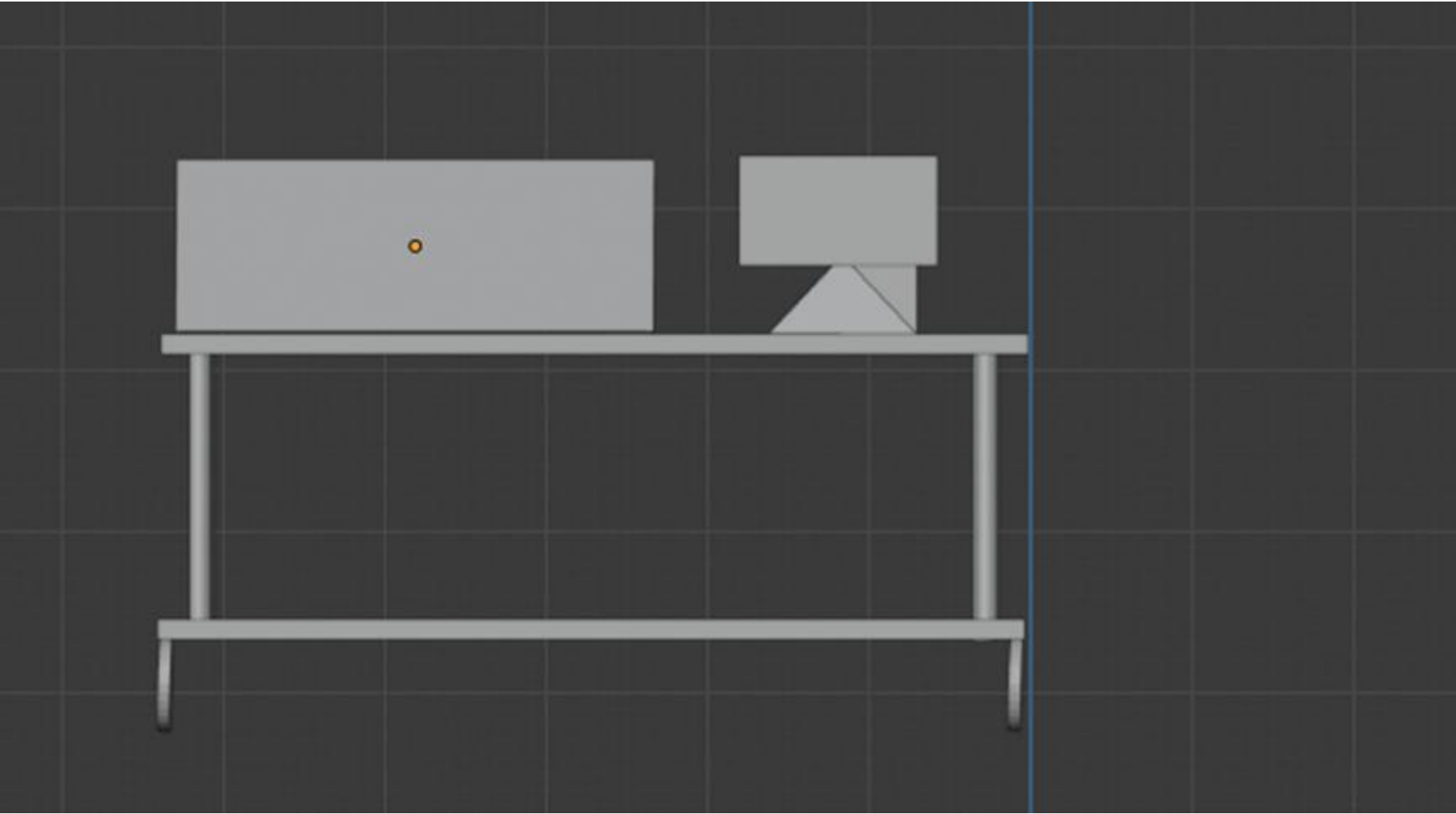

Solid Model –Plan A

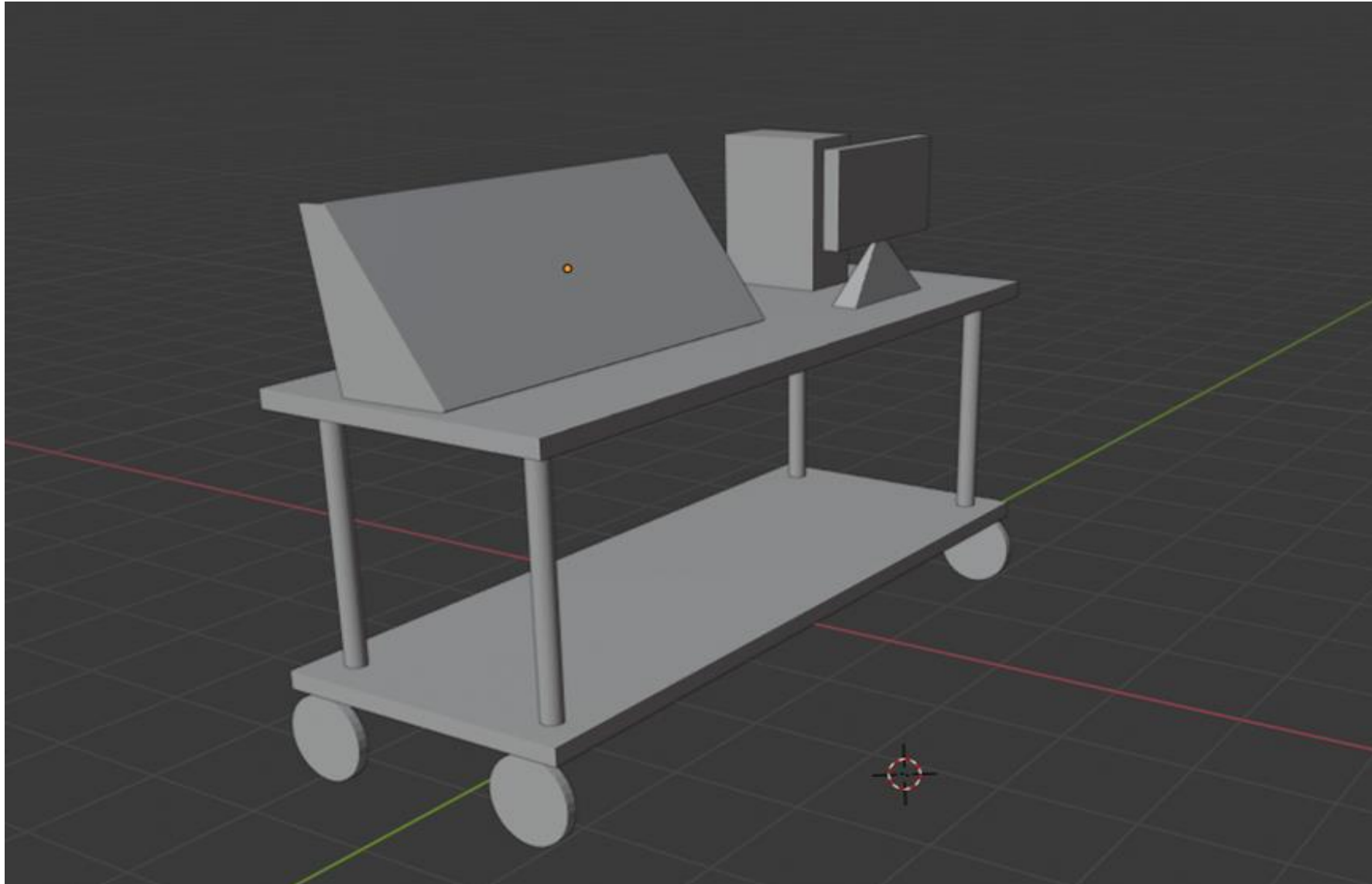

Solid Model –Plan A

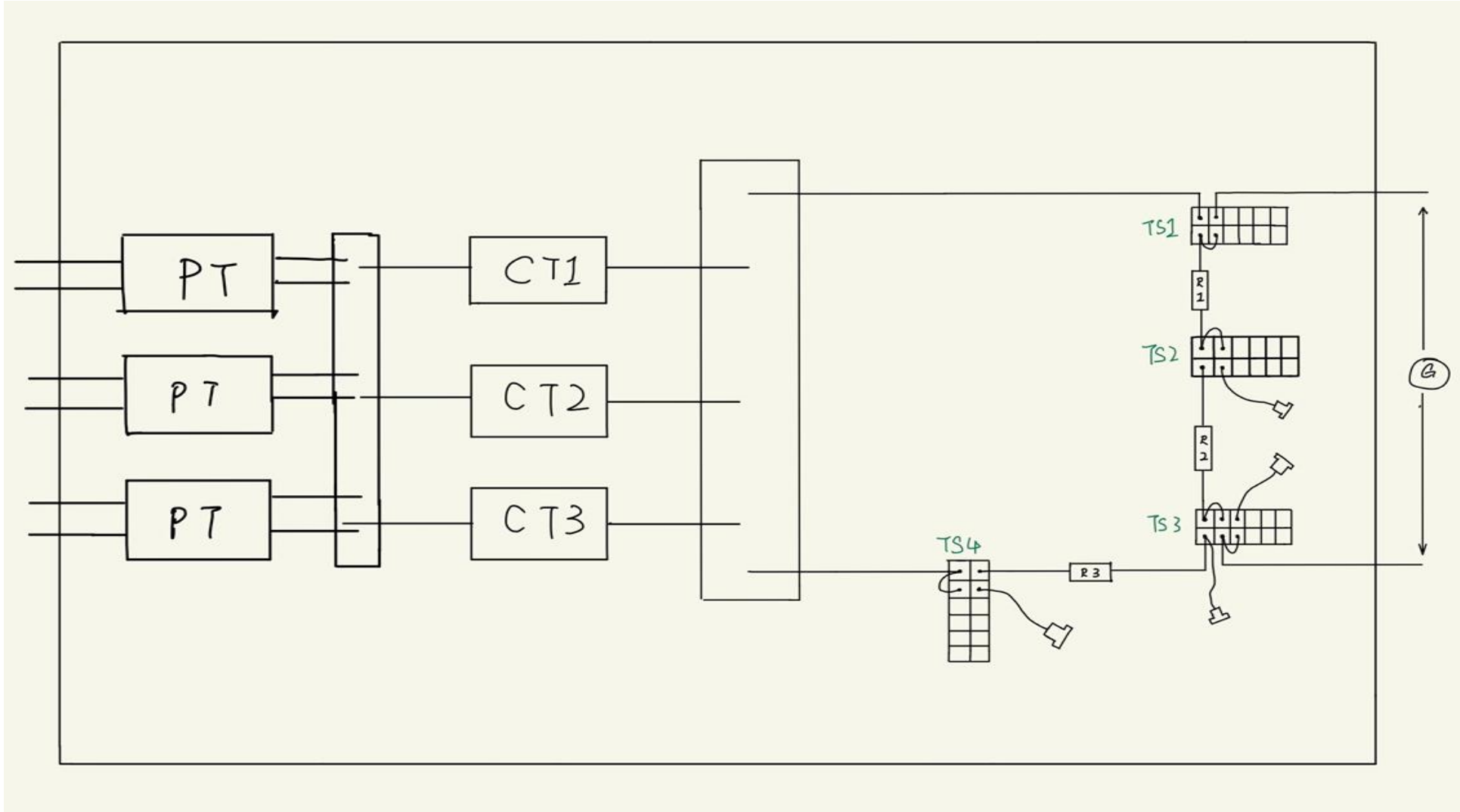

Solid Model –Plan A

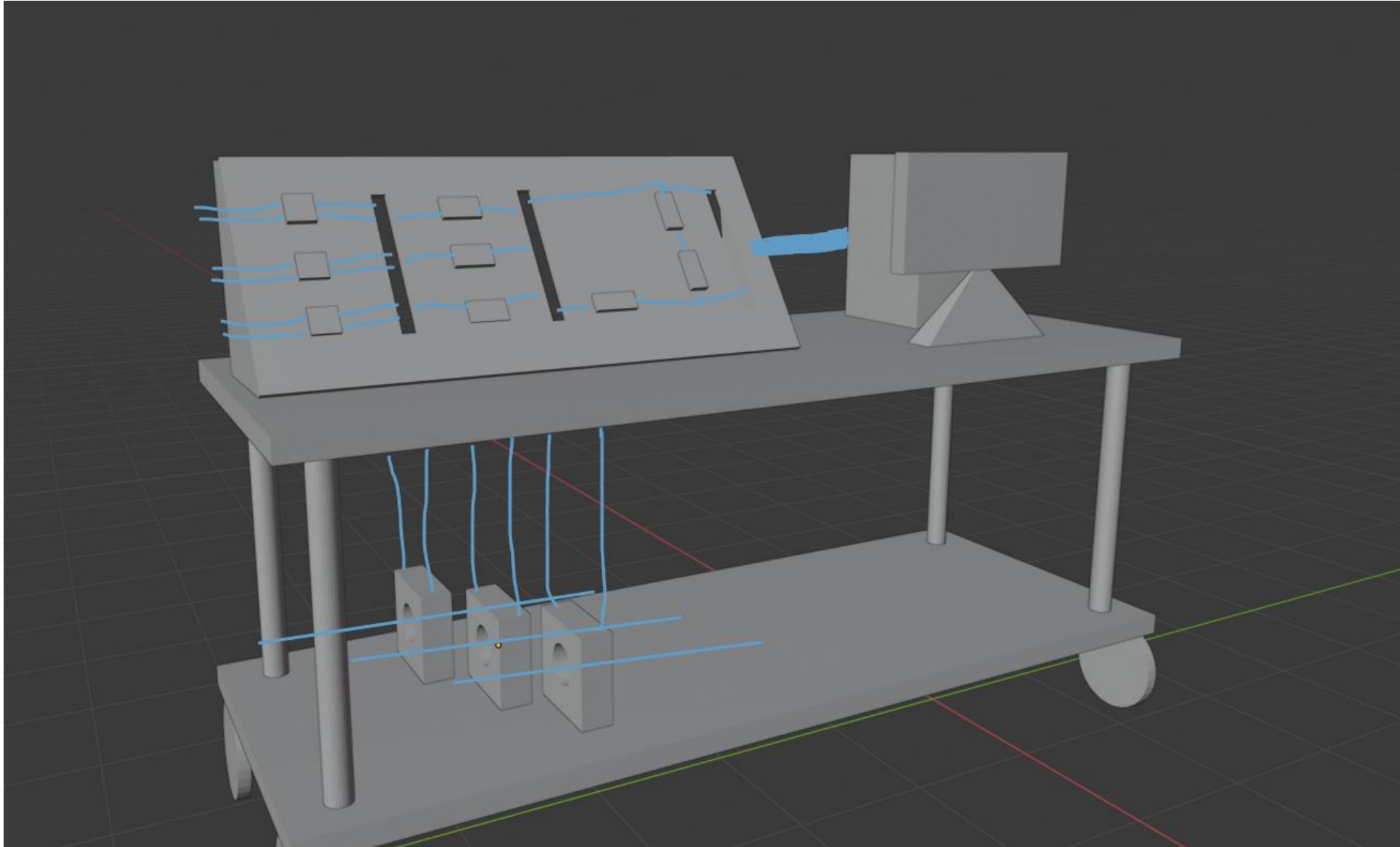

Solid Model –Plan A

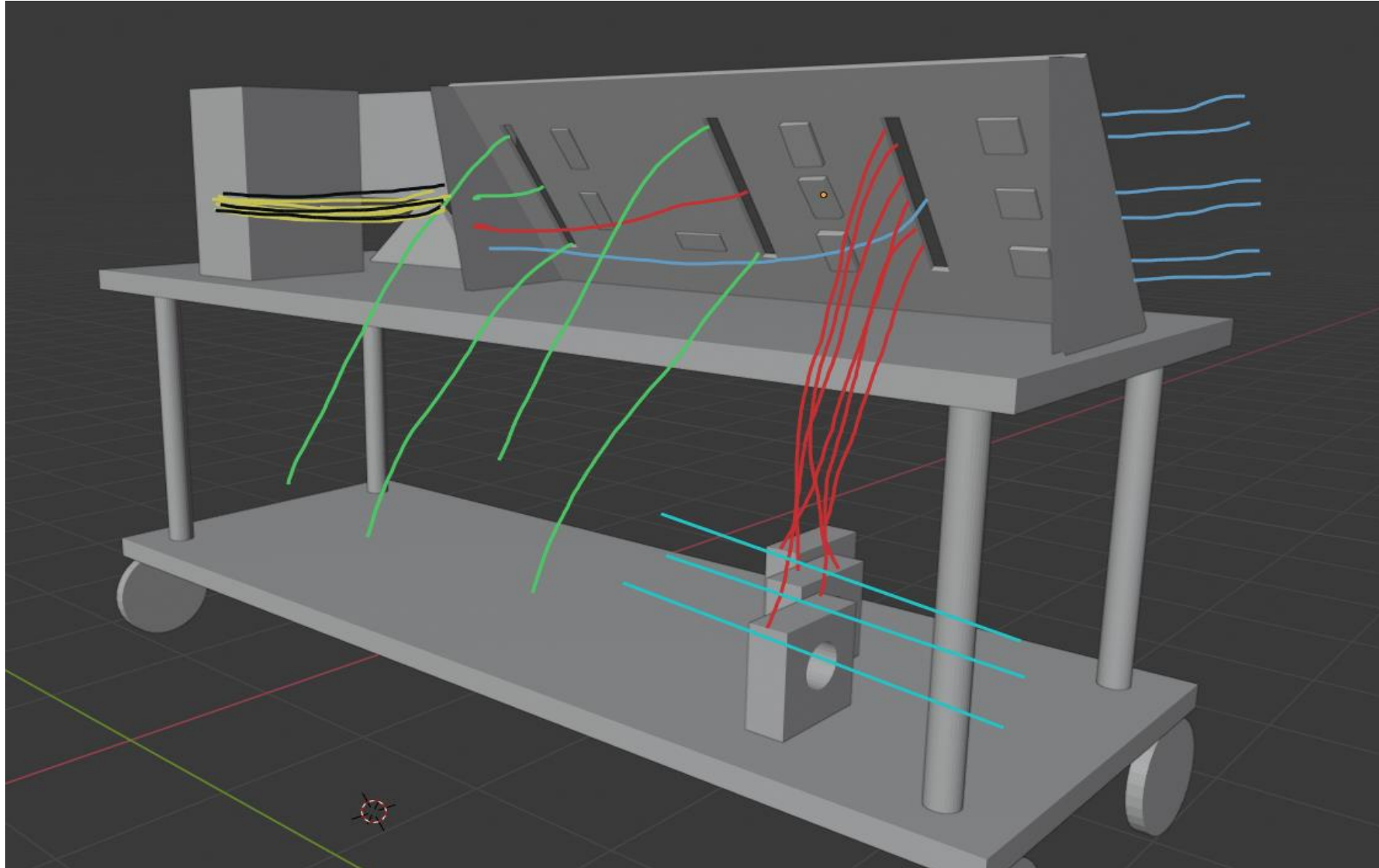

Solid Model-Plan B

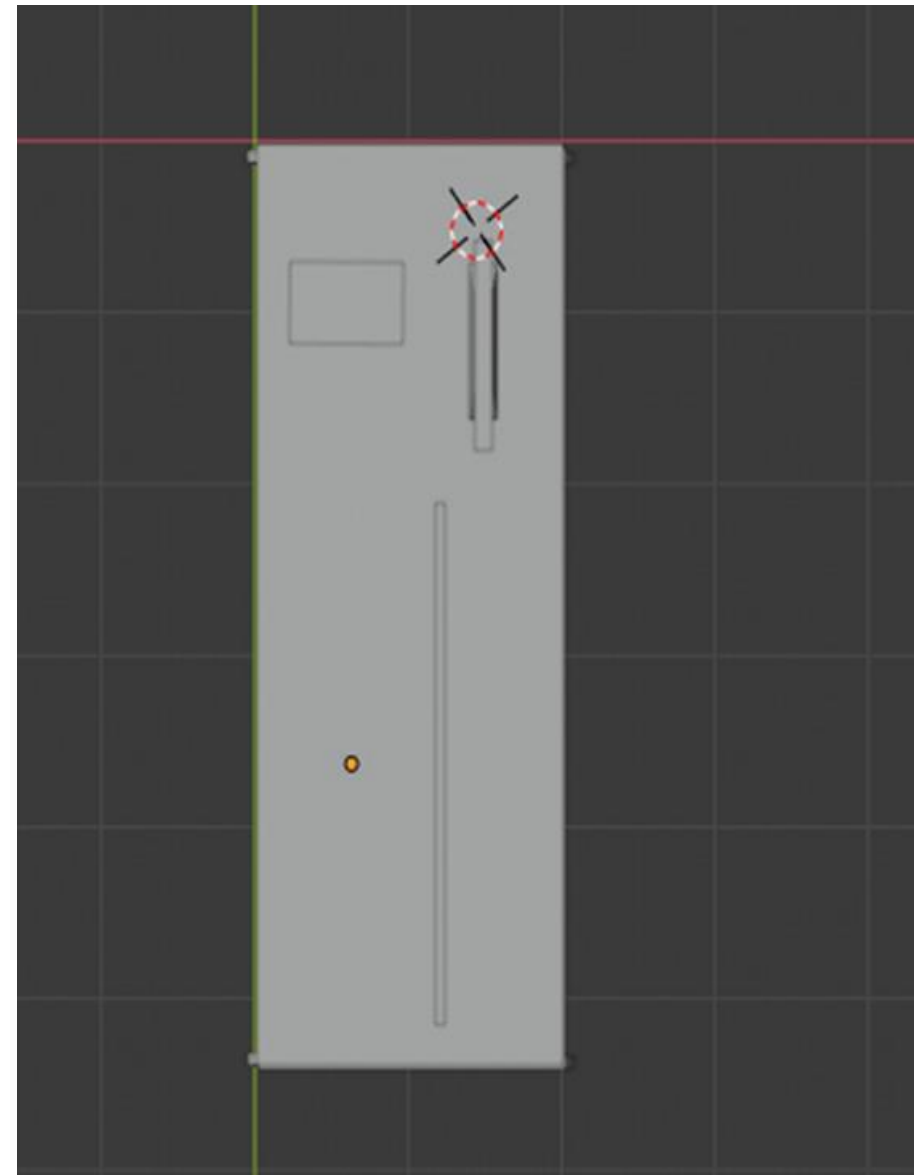
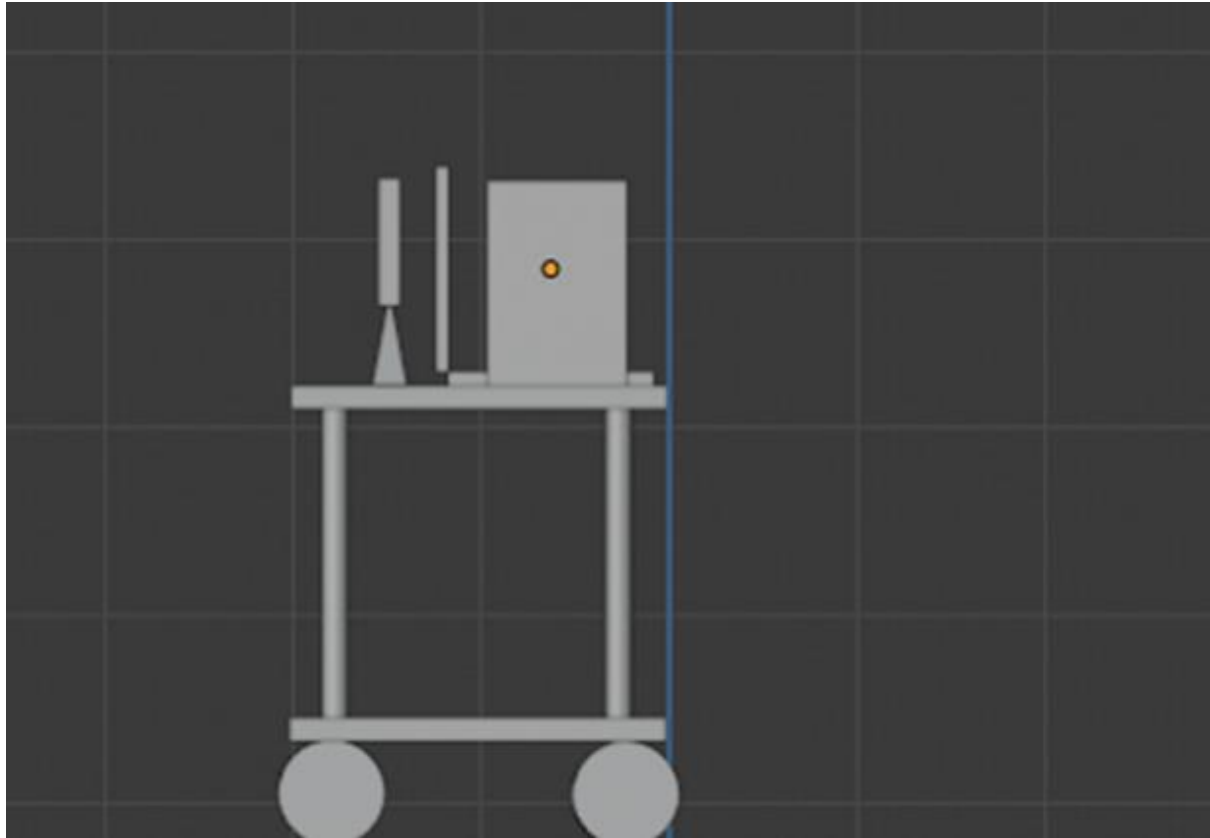

Solid Model-Plan B

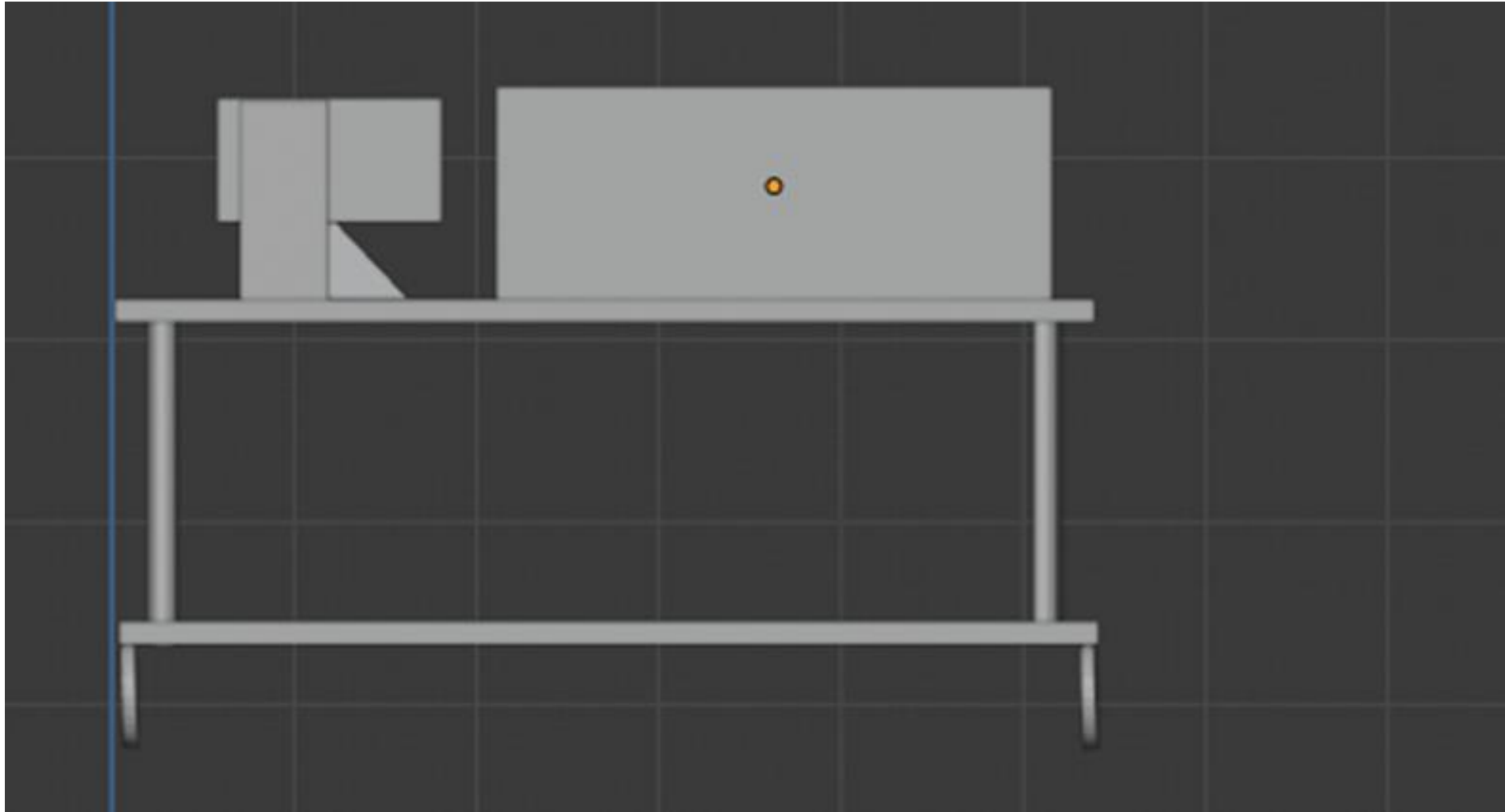

Solid Model-Plan B

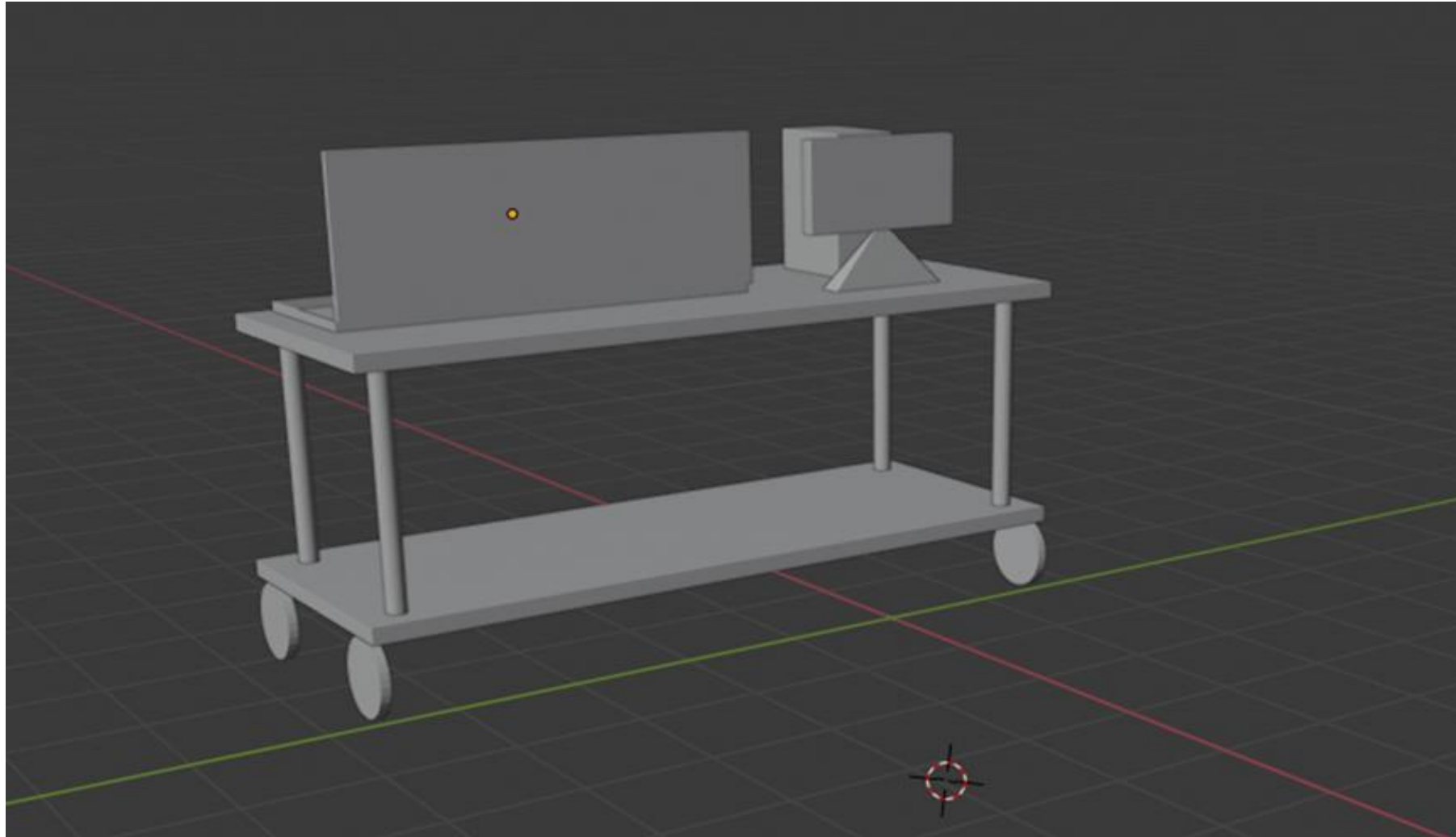

Solid Model-Plan B

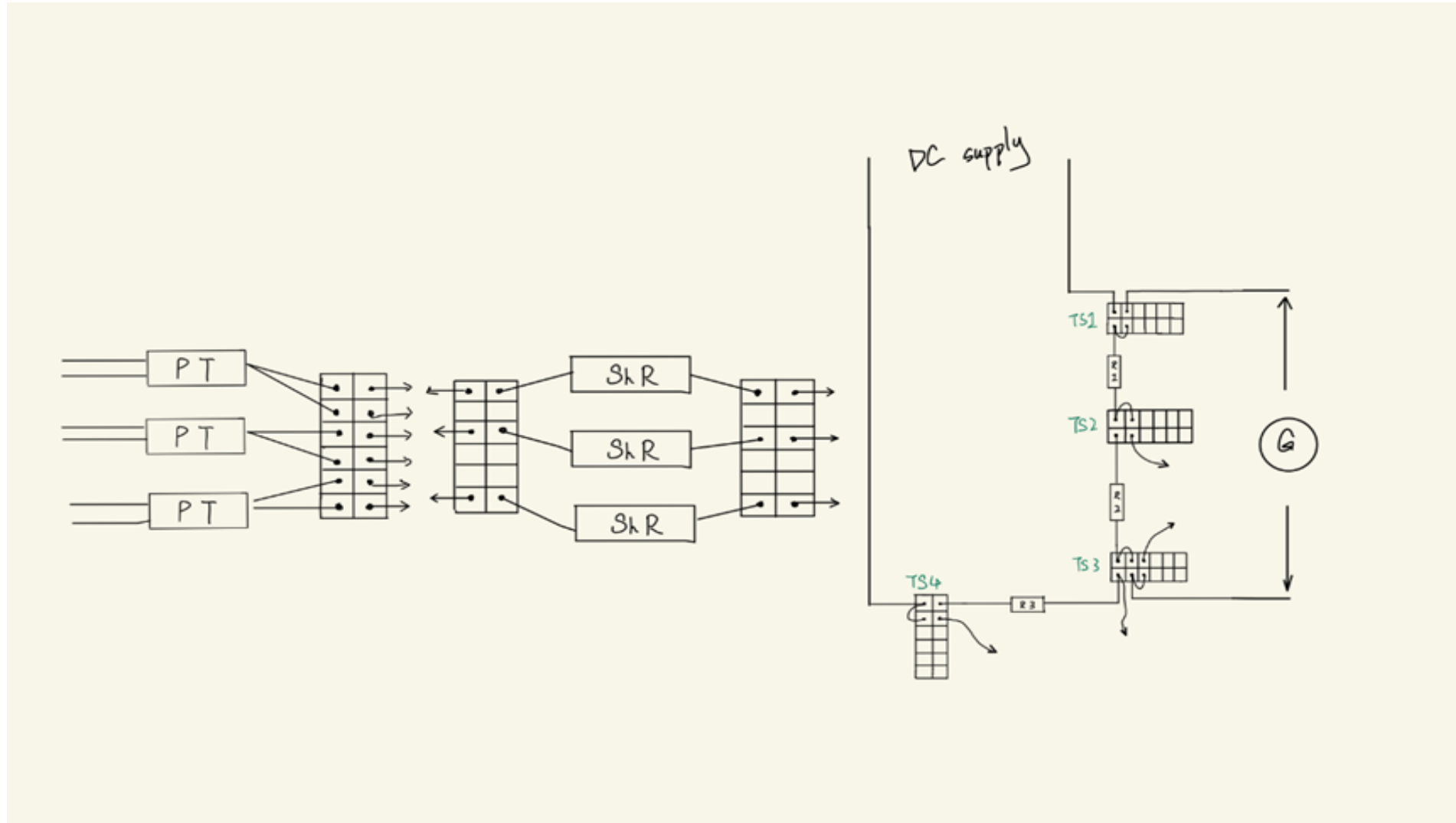

Solid Model-Plan B

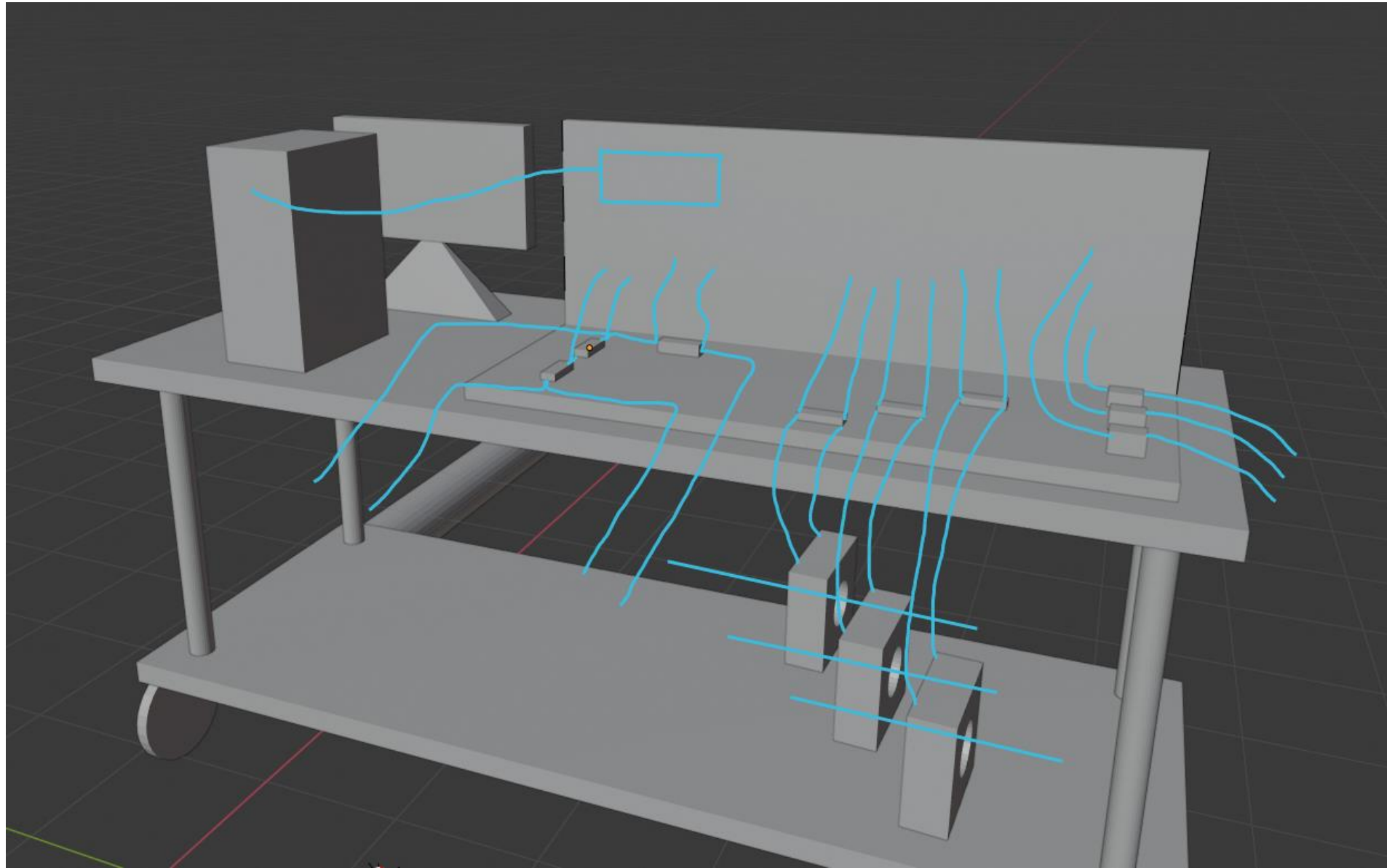

Solid Model

Plan A

Pros:

- 1) All cables are hid behind the PVC board
- 2) All hard devices are fit on the front board making them easy to disconnect and connect.

Cons

- 1) Installation of the hardware is a challenge due to the tilt angle of the front panel
- 2) PVC Board installation requires additional tools

Plan b

Pros:

- 1) Simple connection before experiment
- 2) More clear routing behind
- 3) No additional tools required for installation of all equipment

Cons

- 1) Female banana plug on the front panel cannot be changed



Torque Transducer

?



Project Schedule

Before March

- 1) All equipment we need should to be delivered

Before 03/16/2020

- 1) Test bed production completed
- 2) Test bed usability test completed

Before 04/16/2020

- 1) Experiment and measure

Before May

- 1) Documentation



Questions?



Thank you very much







