

# Inter-Turn Fault Detection for Air Core Reactors

## Team VARSity

Andrew Hoth	hoth1336@vandals.uidaho.edu
Justin Jeter	jete8413@vandals.uidaho.edu
Tanner Mort	mort7075@vandals.uidaho.edu
Jacquelyn Duffau England	duff4880@vandals.uidaho.edu

## Lead Instructor

Dr. Feng Li	fengli@uidaho.edu
-------------	-------------------

## Technical Advisor

Dr. Brian Johnson	bjohnson@uidaho.edu
-------------------	---------------------

## Primary Client Contact

Normann Fischer	normann_fischer@selinc.com
Kevin Damron	kevin.damron@avistacorp.com

Letter of transmittal

Dr. Fischer, Mr. Damron, and Dr. Johnson

This final report summarizes the design of the three phase small scale air core reactor our team was asked to design. Our deliverables include the small scale model and the RTDS model of the system which will be sent to Dr. Brian Johnson at the University of Idaho.

Regards,

Team VARSity

## Table of Contents

Executive Summary.....	4
Background .....	5
Sponsor’s Motivation.....	5
Benefits to Stakeholders .....	5
Problem Statement.....	5
Project Plan .....	5
Team Roles.....	5
Timeline.....	6
System Design.....	7
Concepts Discussed.....	7
Concepts Selected.....	8
System Design for RTDS Model.....	9
Simulation Results.....	10
Budget Summary.....	12
Future Work .....	12
Conclusion.....	13
References .....	13
Appendices.....	14

## Executive Summary

The purpose of this project was to develop a small scale 3-phase air core reactor to determine inter-turn faults. Detecting inter-turn faults of an air core reactor is important because this will allow Avista to better protect the system. This project was created in partnership by Avista and Schweitzer Engineering Laboratories. The small scale reactor was tested in the Analog Model Power System (AMPS) in the University of Idaho BEL power system lab. The reactor was also modeled in Real Time Digital Simulation (RTDS) as a verification method. The data showed as predicted that the fault current on phase A would increase due to the size of the short in the model.

## Background

### Sponsor's Motivation

The sponsor's motivation behind this senior design project was to determine a method of protection for the air-core reactors that are currently in use in Noxon, Montana. Currently, the reactors in Noxon do not have an adequate method for detecting inter-turn faults. The reactors do currently have overvoltage and overcurrent protection.

### Benefits to Stakeholders

The benefits of developing a protection scheme for the air core reactor is that, if implemented in the field, it will prevent the reactor from experiencing a cascading fault which would severely damage the reactor. Having the inter-turn faults detected before a cascade of will provide Avista with the ability to maintain the reactor to keep the system from having a dramatic affect from a cascade fault.

## Problem Statement

Presently, Avista Utilities has invested in a 245 kV 3-phase air-core reactor at its Noxon, Montana hydro plant. This reactor was installed to help adjust the local voltage downwards by approximately 4 kV. The system is split into two 50 M VAr reactors, so that a failure in one reactor does not impact the other reactor. However, Avista has not fully devised a protection scheme to defend the reactors against a single-phase, internal line-to-line fault, or "inter-turn", faults. Avista contacted Schweitzer Engineering Labs, who contacted Asad Iqbal at the University of Idaho, to help develop a functional fault detection scheme to protect the reactors from inter-turn faults. To accomplish this, a scale model needed to be built. This senior design project was initiated to develop and test a scale model of the 3-phase air core reactor to use to develop and test protection settings using at the University of Idaho Analog Model Power System.

## Project Plan

### Team Roles

**Lyn England** – Primary administrator. Assisted with RTDS model and helped design model. Responsible for purchasing.

**Justin Jeter** – Physical model lead. Primary on design and construction of physical model. Worked with Asad to develop protection schemes.

**Tanner Mort** – Primary RTDS lead. Designed and created RTDS model. Assisted with construction of physical model.

**Andrew Hoth** – Project generalist. Assisted in all aspects of the project to help progress to the final product in any manner that was necessary.

### Timeline

<b>TASK</b>	<b>START DATE</b>	<b>FINISH DATE</b>	<b>% Completion</b>
Relay Simulation Rack	9/26/2016	11/10/2016	100%
RTDS Model	9/26/2016	12/15/2016	100%
Assemble Small Scale Model	1/23/2017	3/27/2017	100%
Prototype hand wound coil	2/3/2017	2/3/2017	100%
Hand Wound Coils	2/3/2017	3/8/2017	100%
Assemble Prototype to Relay Simulation Rack	4/11/2017	4/12/2017	100%
Troubleshoot Prototype Setup	4/12/2017	4/13/2017	100%
Capture Fault Data	4/14/2017	4/17/2017	100%
Test Existing Protection and Additional Protection Schemes	4/14/2017	4/17/2017	100%

## System Design

### Concepts Discussed

This project had several safety and equipment limitations. These restraints caused our design process to focus more on meeting these criteria and specification rather than major design concepts. This section will cover some of these limitations and solutions we considered for each.

The very high levels of voltage and current of the Noxon, MT air core reactors installation make it impracticable and unsafe to test directly. To overcome this, we chose to complete this on the University of Idaho model power system. This puts our first restraints to the output of this system at 3 phase 208 line to line voltages. To most closely model a standard protection system our first design considerations included current transformers (CT) and potential transformers (PT) between the model power system values and the relay. The initial estimate of change in current during a fault condition were a very small percent of the prefault current. Once these values are lowered proportionally from the transformers they become indistinguishable from noise or not measurable within the accuracy of the relay. We determined that if we chose values for the model air core inductors correctly we could inject the values directly into the SEL relay. This would also help with safety by keeping expected currents low. The values injected directly into the relay by the model power system are similar to what the relay would experience connected to the real power system through CTs and PTs (around 120 volts line to neutral and 5 amps line). An added benefit of this design consideration is savings on the budget by not purchasing transformers.

The next major design consideration was how to physically model the Noxon, MT air core reactors. What we used for this model would represent the largest cost of our project so considerable time was spent on researching these options. One of the first things we looked into is an actual power system rated 3 phase inductor bank. We found this was not going to be our best options. For one the expense of power system equipment is substantial. This is primarily to have a robustness that was not required for our needs. The second problem that we encountered is they are not available in a large variety of inductance values. To meet our requirements to connect this directly to the SEL relay we would need very specific inductance values. Because of these drawbacks we decided to look at other options. After researching further, we found that custom audio installation used inductors that mostly met our requirements. One problem with this option is there was limited specification of the inductors. We decided to order one each of our two best options and test them ourselves to determine the best option. These were a copper foil and a wire wound inductor [1, 2]. We found that the X/R ratio for the

copper foil was much lower than the wire wound variety. We also found the form factor made it harder to work with. It was also the more expensive version. With this it was a clear choice to use the wire wound inductor.

The next major design consideration was how to create the shorts with in the coils. The initial thought was to scrap off the insulating lacquer from our purchased coils and solder on a test point which could be shorted. We encountered two problems with this design. First the amount of inductance we would be shorting would be very small. Based on our estimation it would not be a large enough change for the relay to pick up the change. The second problem was it would be impracticable to test for or calculate the amount of inductance that was being shorted. It was suggested by the client to hand wind our own inductor with shorting points built in. It was determined that this would difficult to complete with precise inductance between test points. It was proposed that we purchase inductors of several different values which could be rearrange so any combination of inductance could be created and shorted.

One design consideration was a lesson learned in communication. It was unclear whether the client needed to capture the transition from pre-fault to fault. As a team it was assumed that we would need to capture pre-fault and fault data. We designed a fairly elaborate test circuit that would use automation to both create the fault and signal the relay to capture the information. It was estimated that the current through the shorted coils would be as high as 20 amps. Due to the relatively high current much effort was put into ensuring the test fixture could make and break a circuit when the current is at that level. Time was spent building and testing the test fixture. After the project progressed further the client stated that it was not needed to capture this transition. It was also determined the current through the short was much smaller than initially estimated. This portion of the project was abandon and not used.

### Concepts Selected

The first concept selected was the type of inductor coil that would most closely match the Noxon reactors. To meet budget and technical specification we chose to use a wire wound, air core, and audio-inductor. To get the best X/R ratio we chose the largest wire gauge possible, 15 gauge. To minimize the number of coils purchased we picked the highest available inductance value for the majority of coils, 10 millihenry (mH).

To ensure the safety of both operators and equipment we decided the maximum current to flow through any part of the circuit should be limited to 5 amps. Assuming 130 V maximum line to neutral



voltage the reactance should be  $26\Omega$ . At the 60 Hz of the model power system the inductance per phase should be 70mH. This was to be connected in an ungrounded wye. Due to increased inductance when stacking the inductors this was achieved with six 10 mH inductors per phase for phase B and C. An additional resistor was needed in these phases to equal the extra resistance in the test phase. The third phase consist of five 1 mH and 8 coils of varying inductance that total 1 mH.

For the coils in the shorted phase we purchased and hand wound a combination of coils with various values that total 1mH. This was to allow shorting of several different inductance values by combining values. The test fixture was designed to allow these coils to be rearranged so any combination in 100  $\mu$ H increments can be shorted.

The data was captured using an SEL-735. This was chosen as it has a higher sampling rate than the originally planned SEL-487E relay. This allowed for better resolution on the results.

## System Design for RTDS Model

The Real Time Digital Simulator (RTDS) model of the air-core reactor served several different purposes for the project, but the primary reason behind the RTDS simulation was for checking consistency across different models.

Since the RTDS model was relatively simple and quick to create, it was employed prior to ordering coils for the small-scale model to make sure the system was going to operate under desired specifications with regards to phase current and fault current. The RTDS model allowed us to see how much voltage our system could operate under without drawing more than our desired 5 Amps of current per phase. The versatility of the program also allowed us to see the magnitude of fault current in a shorted winding so we could pick the size of wired used to make our test points accordingly. The following diagram is the RTDS model that shows the three phase system.

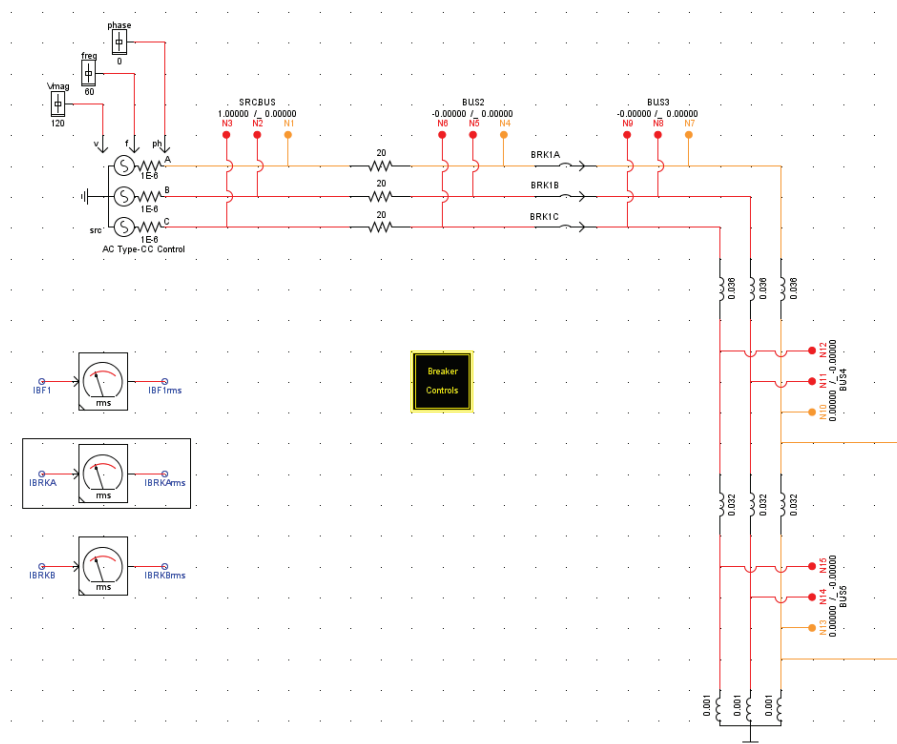

Figure 1: RTDS Circuit

## Simulation Results

After the small-scale model had been constructed, testing was performed on the model power system to gather data. We were able to compare the data captured from the protective relay to the data obtained from the RTDS for similar types of faults and steady state conditions. Simulation tests were also conducted using a scaled-up RTDS model to emulate the true Noxon reactor banks we were modeling. By comparing the data of the different models we were able to prove we had built an accurate small-scale representation of the Noxon reactor banks which would be adequate for testing protective relaying algorithms. As seen in Figures 2 and 3, the current waveforms created from a similar magnitude inter-turn fault are approximately the same.

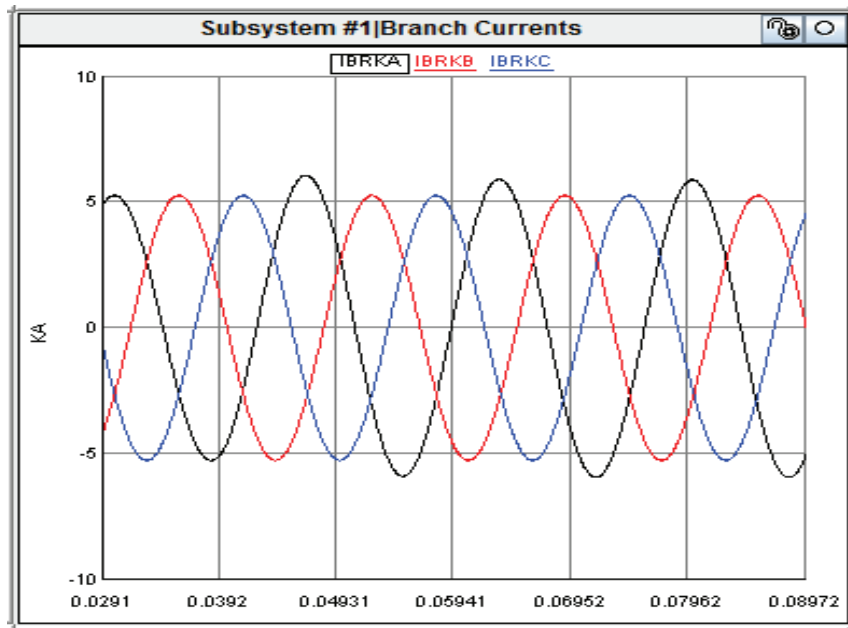

Figure 2: RTDS 10mH Fault Simulation

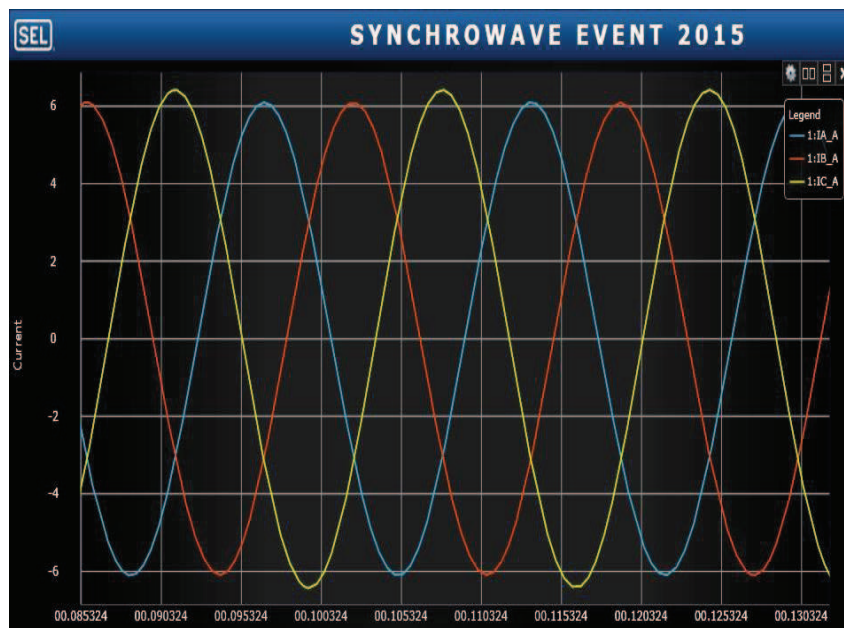

Figure 3: Small-Scale Model 5mH Fault

## Budget Summary

<b>Expenses</b>	
Trip to Noxon	\$331.57
Test Coil (Janzen)	\$45.81
Test Coil (MadiSound)	\$149.33
Bulk Order of Coils (Jantzen)	\$1,222.83
Bulk Copper Wire Order	\$245.23
Test Coil Purchase	\$130.07
Tools For Coil Structure	\$139.13
EXPO Poster	\$116.60
<b>Total Expenses</b>	<b>\$2,380.57</b>
<b>Total Budget</b>	<b>\$4,800</b>
<b>Remaining Budget</b>	<b>\$2,419.25</b>

## Future Work

There are two main possibilities for future work that can use this project as a base line. Relay settings development and transient response studies. Both would need very limited hardware changes, if any, to the test set up for practical testing. Here is a summary of how each of these could potentially proceed.

One thing to note from our results is that they have not been implemented in a relay. We proved the concept for protection in Mathcad. Although this proves that the protection algorithm is possible it does not consider the limitations of the relay. Some of these limitations include sampling rate, A/D resolution process interval of protection and mathematical variables, and limited programming and logic capabilities. Some of the algorithms that need to be developed are averaging the zero sequence voltage over several seconds and comparing to zero sequence currents. It needs to be determined if the Mathcad logic and algorithms can be developed in SEL free form logic. If that is the case, an application guide can be published explaining these steps to be placed on SEL's website. If it is determined that this cannot be done with free form logic then the algorithms must be developed and added to SEL product firmware. In either case, once it is implemented into the relay, the comtrade events that were created during this project can be played through a testing device to confirm the protection scheme works as intended. There would be no need to use the physical scale model. Depending on interest of SEL and Avista, this task could potentially be completed by members of this design project. This would have no

additional cost for SEL or Avista. It was discussed as being completed by SEL employees who were on the design team. It would require technical expertise from both SEL and Avista as well as man hours to work on this. The benefit would be potentially better settings for air core reactor protections and possible paper presented at conferences.

Using the physical hardware the transient response of the system can be tested. The team created hardware to create the shorting events as they happen. This was determined to not be needed for the graduate student thesis and was not used. This system used the pushbuttons on an SEL-487E to close a contact to create the inter-turn short and create an event at the same time. This system could be used to create and monitor transients of the system. This future project may require a relay that is designed to capture transient signals. The SEL- T400L would be the recommended model. It includes megahertz sampling that would allow this type of capture. For cost of future project it would include this relay and miscellaneous expenses. Retail cost for this relay is \$12,000, however if donated by SEL it would cost SEL less than this. This relay could also be used by the University other Projects and testing. Using our project as a baseline, miscellaneous expenses should be around \$300.

## Conclusion

The small scale three phase air core reactor was designed, constructed and tested, providing a way to test inter-turn faults of an air core reactor and collect the fault current data on the Analog Model Power System. The RTDS model provided additional data that verified the results from the small scale model. The data collected from the small scale system helped the graduate student better determine a protection scheme for the inter-turn faults of an air core reactor.

## References

[1] Air Core Wire Coil. (2017, January 11). Retrieved November 14, 2016, from <http://www.jantzen-audio.com/air-cored-coil/>

[2] Components, M. S. (2017, May 02). Goertz CF6.0 (12 AWG) Copper Foil Inductor. Retrieved November 14, 2016, from <https://www.madisoundspeakerstore.com/goertz-12-awg/goertz-cf6.0-12-awg-copper-foil-inductor/>

## Appendices



### **Quality/Purity of copper used in Jantzen Audio inductors:**

All Jantzen Audio inductors, both wire and foil based are made with copper that is in accordance with ETP (Electrolytic-Tough-Pitch) C11000 and an IACS certification of a minimum of 100% conductivity.

C11000 copper has a guaranteed purity of 99.9% or higher. The copper purity will often be higher, but 99.9% is the margin which our suppliers of copper wire and copper foil will guarantee as a minimum.

The oxygen content of ETP C11000 certified copper is between 0.02 and 0.04%.

### **Copper types and copper purity used for audio grade inductors in general:**

Oxygen free copper C10100 OFE is 99.99% pure copper wire or foil and is mainly used for appliance areas where it is important that the copper does not contain any Silver (Ag) or other foreign elements.

This can be i.e. cryogenics, aerospace or other industries where the purity and oxygen level of the copper used needs to be 99.99% pure and virtually free of oxygen.

For audio appliance using Oxygen free copper C10100 OFE copper has no advantages, as there is no possible way for the human ear to hear any difference in performance between inductors made from C10100 OFE copper or ETP (Electrolytic-Tough-Pitch) C11000 copper.

Using Oxygen free copper C10100 OFE is 99.99% in audio inductors would make them unnecessarily expensive and to our best knowledge no-one in the audio industry can claim, nor prove that they use this grade of copper with certificates or independent lab tests.

As a rule of thumb, any inductors using Oxygen free copper should be 3 to 4 times more expensive than the average market price for inductors using ETP C11000 certified copper (99.9%).



### **Inductors versus capacitors:**

For capacitors, pure silver or Oxygen free copper C10100 OFE is often used for the lead-wires, because capacitors in their nature are more revealing when it comes to audio appliance.

Inductors play an equally important role in crossovers, but in a different way.

Inductors do not have the ability to "color" or "change" the sound profile in the same direct way that changing/upgrading capacitors does.

The role of inductors have more to do with performance in areas like increased power handling and adding dynamic headroom by choosing the right type of inductor.

As long as the inductor is well made from high quality copper the signal pathing will be as it should be.

### **What does it take to make a good audio grade inductor?**

The most important factor for a good quality audio grade inductor is that the copper used is of a certified good quality, like the ETP (Electrolytic-Tough-Pitch) C11000 copper we use at Jantzen Audio any copper grade above this grade has no technical advantages or performance enhancing qualities for audio appliance. Using a higher grade would make inductors more expensive than necessary.

Furthermore the winding integrity has to be impeccable and also the overall quality of the inductor is of course a factor.

At Jantzen Audio we wind our induction coils (wire and foil) on semi-automatic machines and we use the "baked wire" technology to make wire based coils with no need for plastic bobbins.

For foil type inductors we have built our own special semi-automatic machines that allow for tight windings and full control of layering and insulation.

### **This means we can offer these very low tolerances:**

- **Air Core, Iron Core & Litz Wire inductors:** +/- 3% (inductance) & +/- 5% (RDC)
- **C-Coil inductors:** +/- 5% (inductance) & +/- 10% (RDC)
- **Wax Coil & Cross Coil inductors:** +/- 2% (inductance) & +/- 5% (RDC)



## Copper wire (supplier information)

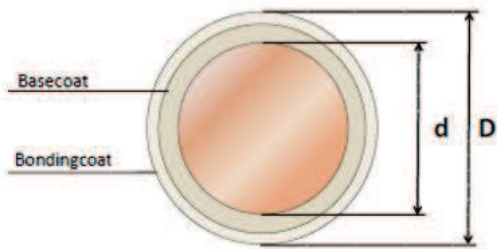

Approximate solder time, independent of grade

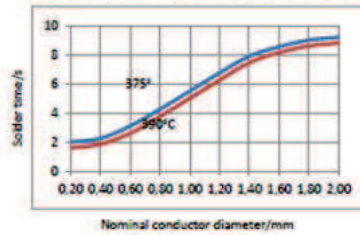

Bonding strength

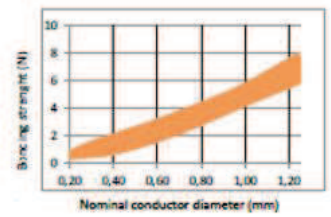

**D - d = Increase**

(Increase of bondingcoat may be lower than stipulated by IEC, but total increase (D-d) and bonding strength within specified values guaranteed)

Main characteristics	Test method	Property values	Test values for a 180 sample (1,00 mm, Gr1)
<b>Thermal properties:</b>			
Heat shock	IEC 60851 - 6.3	≥ 200°C	≥ 200°C
Cut-through	IEC 60851- 6.4	≥ 230°C	≥ 240°C
Temperature index	IEC 60172	≥ 180°C1)	≥ 180°C *1)
<b>Electrical properties:</b>			
Conductor resistance	IEC 60851 - 5.3	0,01724 Ωmm <sup>2</sup> /m	0,01724 Ωmm <sup>2</sup> /m
Conductivity	1/R	> 58 m/(Ωmm <sup>2</sup> )	> 58 m/(Ωmm <sup>2</sup> )
Breakdown voltage	IEC 60851 - 5.4	IEC 60317-0-12)	7,8 kV
<b>Mechanical properties:</b>			
Elongation	IEC 60851-3.3	IEC 60317-0-1 *2)	40%
Springiness	Springiness *3)	IEC 60317-0-12)	41°
	IEC 60851-3.4		
	Springback *4)	≤ 5°	-
Flexibility	IEC 60851-3.5 - Mandrel wind.	1 x Ø	1 x Ø
Adherence	Jerktest *5)	No loss of adhesion	OK
	IEC 60851-3.5		
	Peeltest *6)	min. 110 *7)	-
<b>Bonding:</b>	IEC 60851-3.7	IEC 60317-35.18	6,0 N at 190°C

1. According to supplier certificate
2. Values depend on dimension
3. Up to an including 1,60 mm
4. Over 1,60 mm
5. Up to and including 1,00 mm
6. Over 1,00 mm
7. Revolutions x nominal dimension

Values above are for information only.  
All values noted are typical and can vary between lots and dimensions.



## **Copper wire (supplier information)**

### **Properties:**

- Class 180, grade 1B and 2B
- Directly solderable
- Short time solder
- Can be bonded at 180°C - 200°C
- Excellent resistance to mechanical stress

### **Specifications:**

- C11000 - IEC 60317-35 – 100% IACS

### **Class 180:**

- Temperate index  $\geq 180$  °C
- Heat shock  $\geq 200$  °C

### **Conductor material:**

- EN 1977 - ETP1 CW003A
- EN 1977 - ETP CW004A
- ASTM B49 - ETP C11000/C11040

### **Insulation:**

- Basecoat: Polyurethane
- Bondingcoat: Modified aliphatic polyamide

### **Dimension range:**

- 180 – Gr. 1B =  $0,200 \leq \varnothing \leq 2,000$  mm
- 180 – Gr. 2B =  $0,200 \leq \varnothing \leq 2,000$  mm



**Copper foil (supplier information)**

**Certificate of products**

R-8-017A

Customer No		YMA0017							
Raw material		TUI		Sizes		0.18*47			
Test items		STD	Value				Result	Testing tool	
			1	2	3	4			
Sizes	Width (D; mm)	47 <sup>±0.01</sup>	47.06	47.08	47.10	47.06	OK	Vernier Caliper	
	Thickness (H; mm)	0.18 ± 0.01	0.183	0.185	0.186	0.189	OK	micrometer	
chemical component (%)	Element	Cu	Fe	Zn	Sn	Bi	Ni	/	FAAS
	STD	≥99.97	≤0.004	≤0.003	≤0.002	≤0.001	≤0.002		
	Results	Rest	0.0020	0.0015	0	0.00020	0.0011		
RoHS (%)	Element	Cd	Pb	Hg	CR(VI)			/	x-ray fluorescence spectrometer
	STD	≤0.0005	≤0.01	≤0.05	≤0.01				
	Results	ND	ND	ND	ND				
Surface	Smooth, flawless						OK		
Notes:	ND means No, or ≤2PPm								
Result:	OK								



**Independent lab test**

	<b>INSTITUTE OF NON-FERROUS METALS</b> <b>ANALYTICAL CHEMISTRY DEPARTMENT</b>	
	<i>44-100 Gliwice, Sowińskiego 5, tel. 32 2 380 278, fax 32 2 316 933</i> <i>e-mail: ewasz@imn.gliwice.pl</i>	
<b>REPORT OF TESTING No: 0464/2016</b>	<b>Date</b>	2016-07-27
	<b>Page</b>	1/1

**1. Customer**

Polink Wilkowo sp. z o.o.  
 66-200 Świebodzin  
 Wilkowo 62

**2. Testing objects, properties**

Testing objects : two samples marked as „Cu – foil and Cu – winding wire”  
 Kind of tests: semi-quantitative analysis  
 Date of receiving the samples for testing : July 2016

**3. Testing methods**

- X-ray fluorescence method (XRF).

**4. Results of tests**

Sample „Cu - foil”	
Element	Concentration, %
Cu	99,9
Si	0,04
S	0,03
Fe	0,02
Cl	0,02
Al	0,01

Sample „Cu – Winding wire”	
Element	Concentration, %
Cu	99,8
Si	0,05
Mn	0,04
Zn	0,04
S	0,03
Al	0,03

.....End of Report.....

  
 Contractor

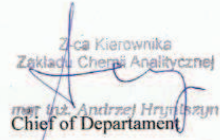
Z-ca Kierownika  
 Zakładu Chemii Analitycznej  
  
 mgr inż. Andrzej Hrynyszyn  
 Chief of Department

- Results presented in the report concern only the objects mentioned in the report.
- Written complaint could be turn up to 30 days from the date of receiving the report.
- After testing, the test object shall be deposited in the archives, where it is stored for a period of two months. Report could be duplicated only entirely. Permission of Institute of Non-Ferrous Metals is necessary for each duplication.



### **Important notes regarding the independent lab test**

- Polink Wilkowo Sp.z.o.o. is the name of our production company / factory in Poland.
- The test was done by an independent government funded institute for non-ferrous metals (chemical analysis department)
- The X-Ray fluorescence method (XRF) can only show 1 digit for purity measurements. Different contaminants found are shown in percentages on their own, then deducted from 100% pureness factor.
- The test has a tolerance of three hundreds in precision (+/- 0.03%)
- When comparing the purity measurement of a lab test with the purity statement issued by suppliers, one must take into account that the purity measurements done by copper suppliers are based on measuring the first processing of copper mass/rods and not further processed copper products like winding wire or foil.
- Once the raw copper mass has been processed, outside contaminants like Sulphur (S), other airborne impurities and impurities originating from the processing process are inevitable and will lower the purity slightly compared to the raw unprocessed copper.
- The independent lab test shows that the processed copper we use have the following purity (factored in with a +/- 0.03% margin as shown below):

Copper foil: 99.85% to 99.91% purity

Copper wire: 99.78% to 99.84% purity