

EXPO
engineering ▲ design

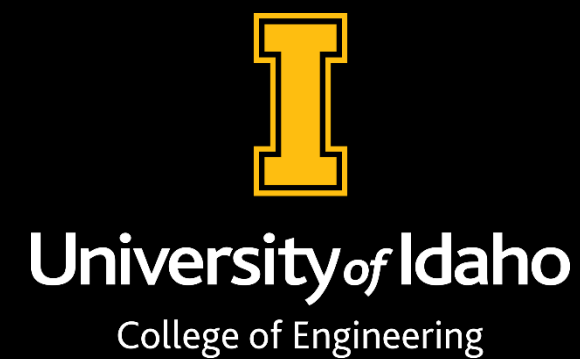

INDEPENDENTLY RAN RENEWABLE INTEGRATED SYSTEM

KATHRYN WARNER, CHARLIE DIMKE,
JASON FLOYD

TEAM LIGHT THE WAY

Charlie Dimke

Group Role: Team Recorder
Major: Electrical Engineering

Jason Floyd

Group Role: Team Lead
Major: Electrical Engineering

Kathryn Warner

Group Role: Finance
Major: Electrical Engineering

Dr. Brian Johnson

Group Role: Lead Instructor

Abdallah Smadi

Group Role: Graduate Mentor

Phillip Hagen

Group Role: Graduate Mentor



Objective

Design a lighting system that is independently powered, mobile and powers flashing LEDs.

Value Proposition

What are the alternatives?

Why does this project matter?

Why do we care?

PRODUCT REQUIREMENTS

- Transmit and Receive signals from juxtaposed units
- Power a flashing LEDs light bar
- Self-Powered Unit
- Attach to multiple diameters of street poles and sign posts



SYSTEM DESIGN

Concept Sketch

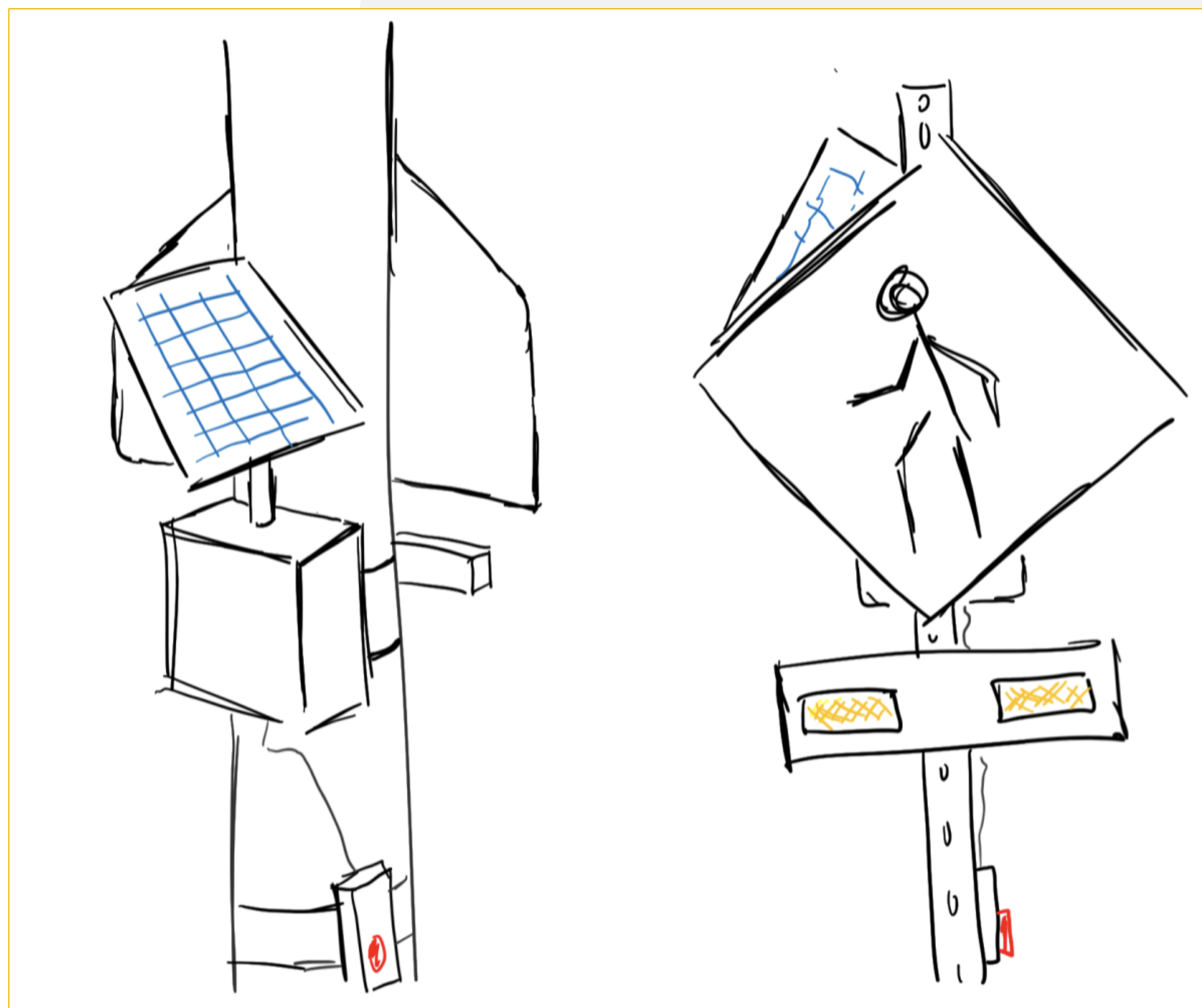

Wiring Design

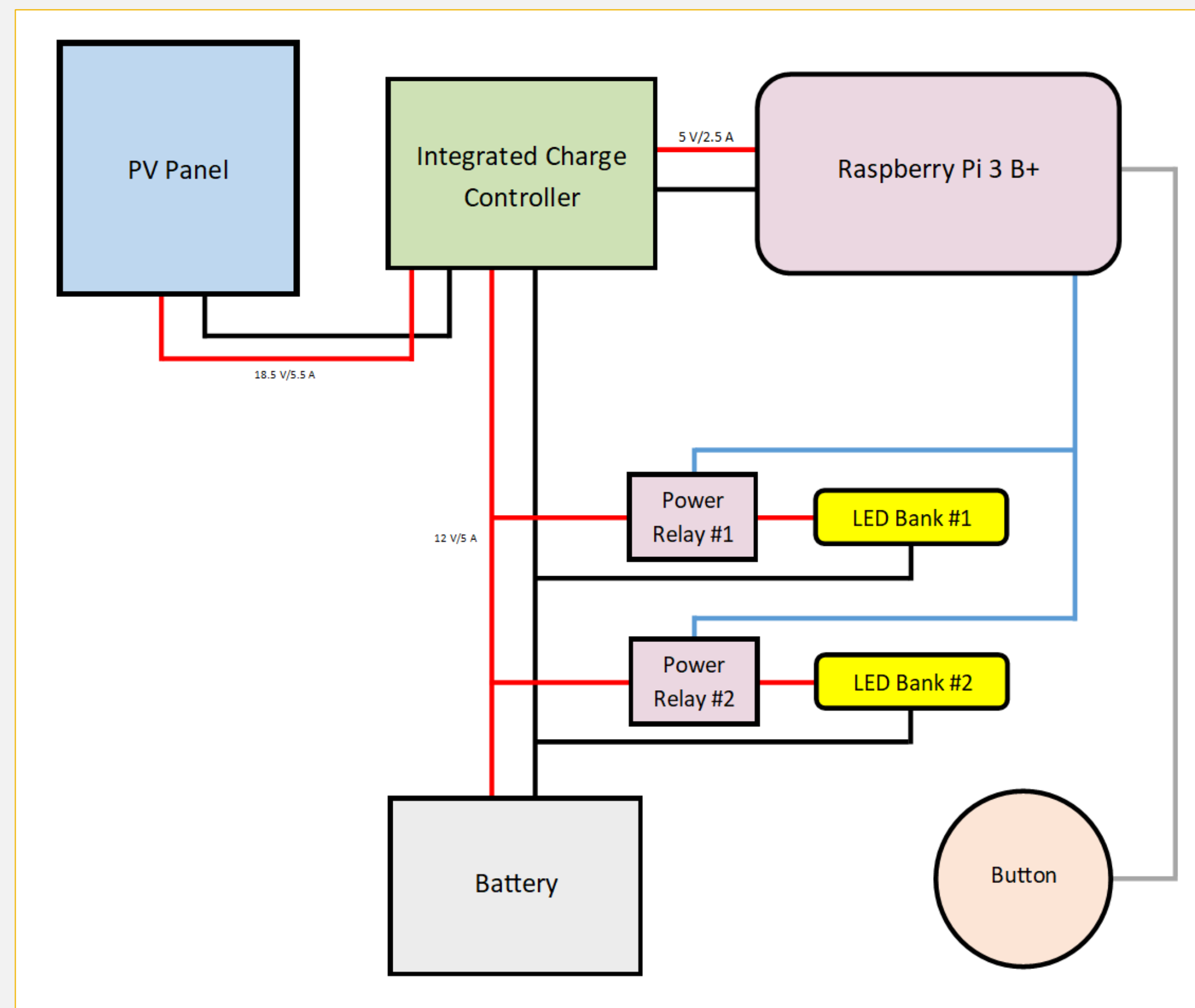

SYSTEM DESIGN: MOUNTING

- Enclosure
- Screw for metal posts
- Rings for round poles

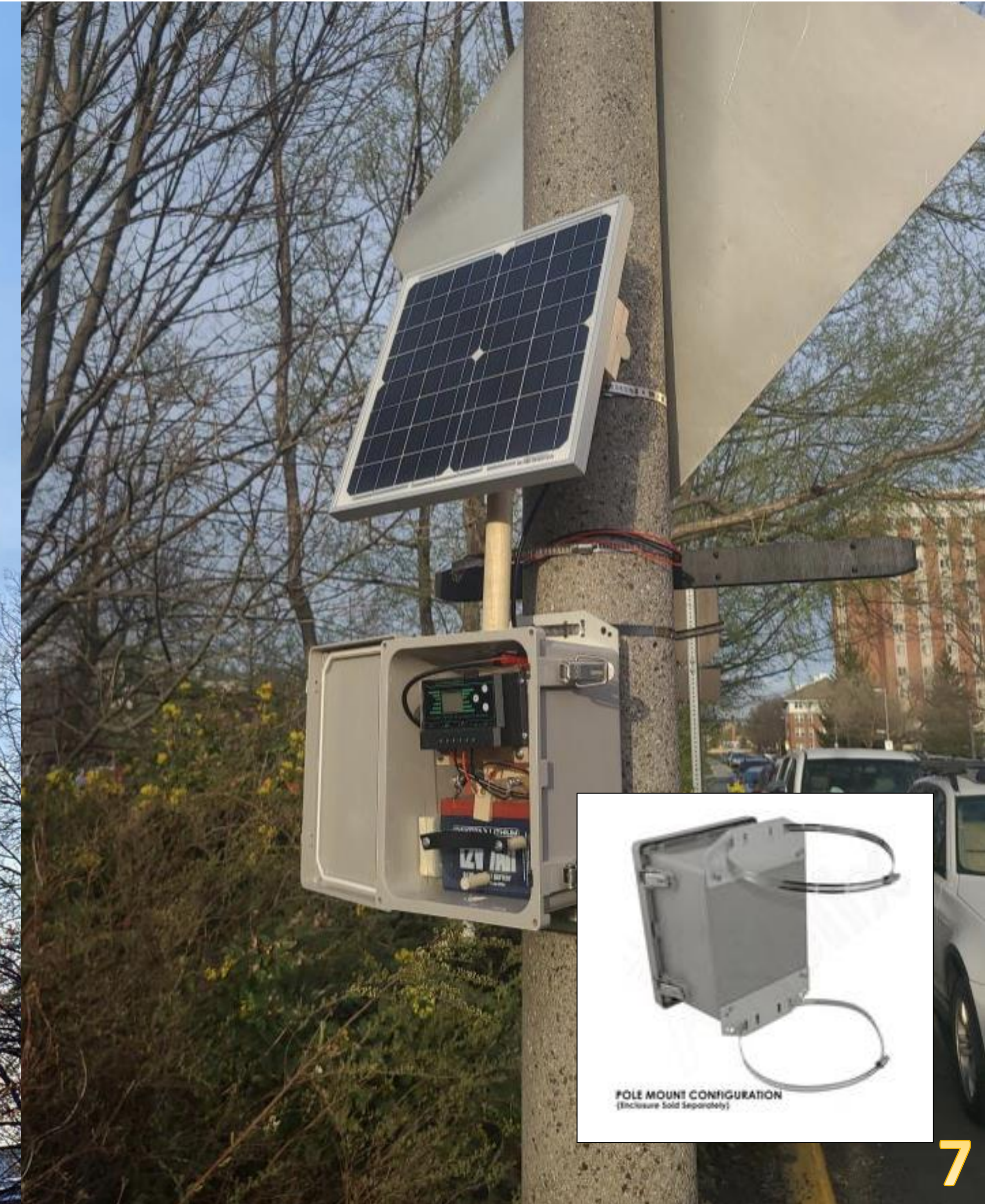

POLE MOUNT CONFIGURATION
(Enclosure Sold Separately)

SYSTEM DESIGN: LIGHTING

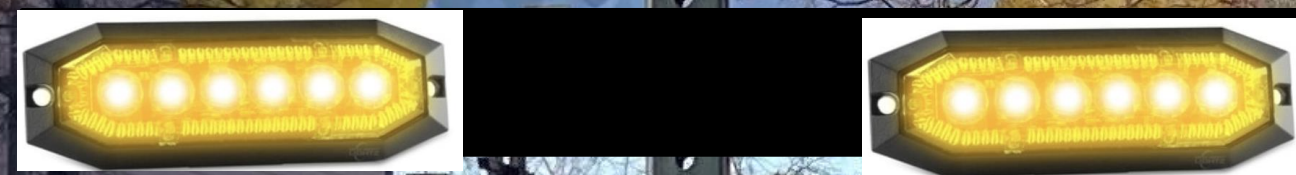

SYSTEM DESIGN: SIGNAL TRANSMISSION



- Raspberry pi 3B+
- Raspberry pi 0
- Wifi



Raspberry pi 3B+

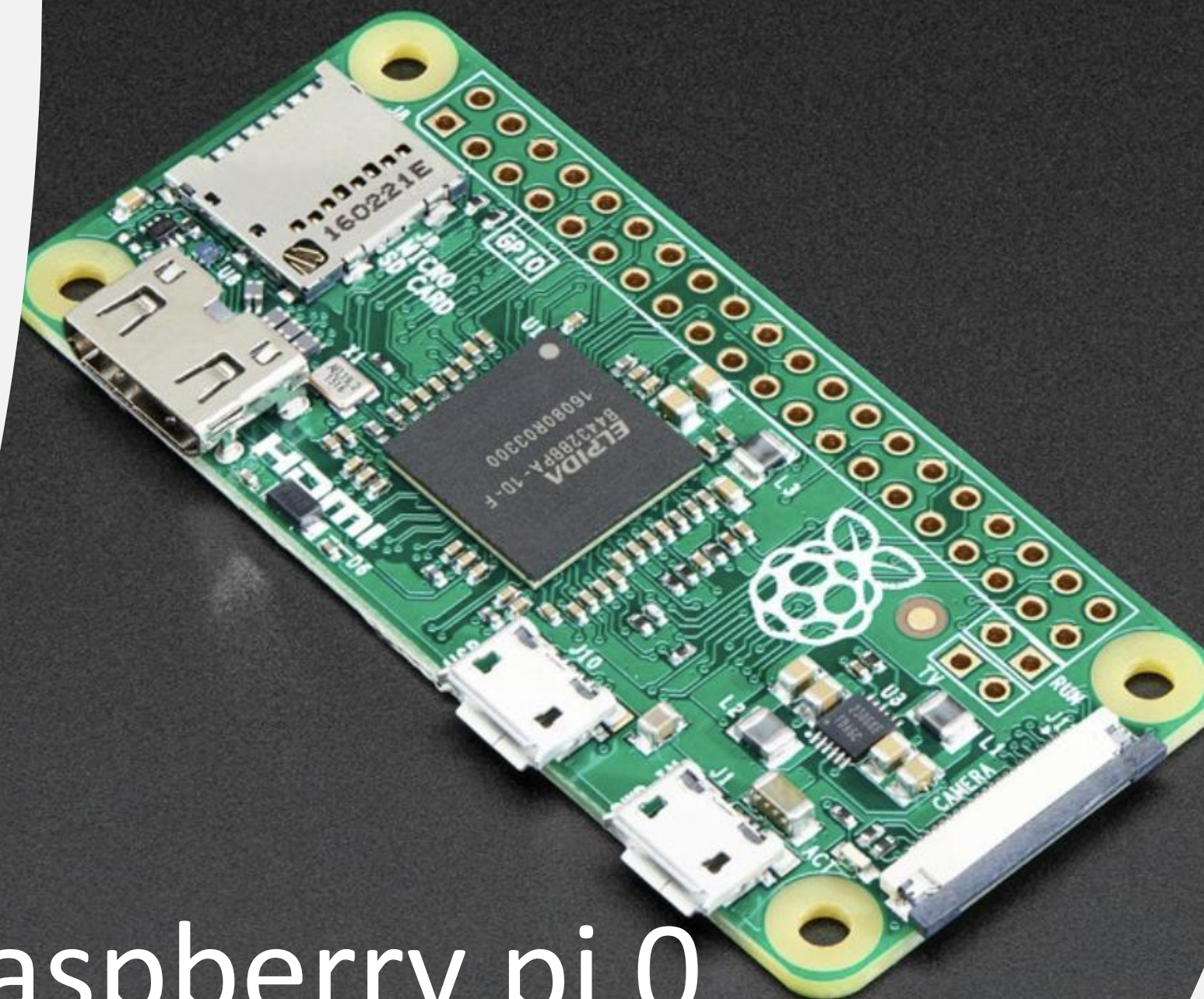

Raspberry pi 0

VALIDATION

I Solar Panel

I Charge Controller

I Battery

I LEDs

I Code



MANUFACTURING PROCESS

- Light Bar
 - Fitting LEDs
 - Wiring
- Enclosure
 - Placement / fit for battery, charge controller, pi's and wires
- Solar Panel Mount
 - Rotational
 - Height

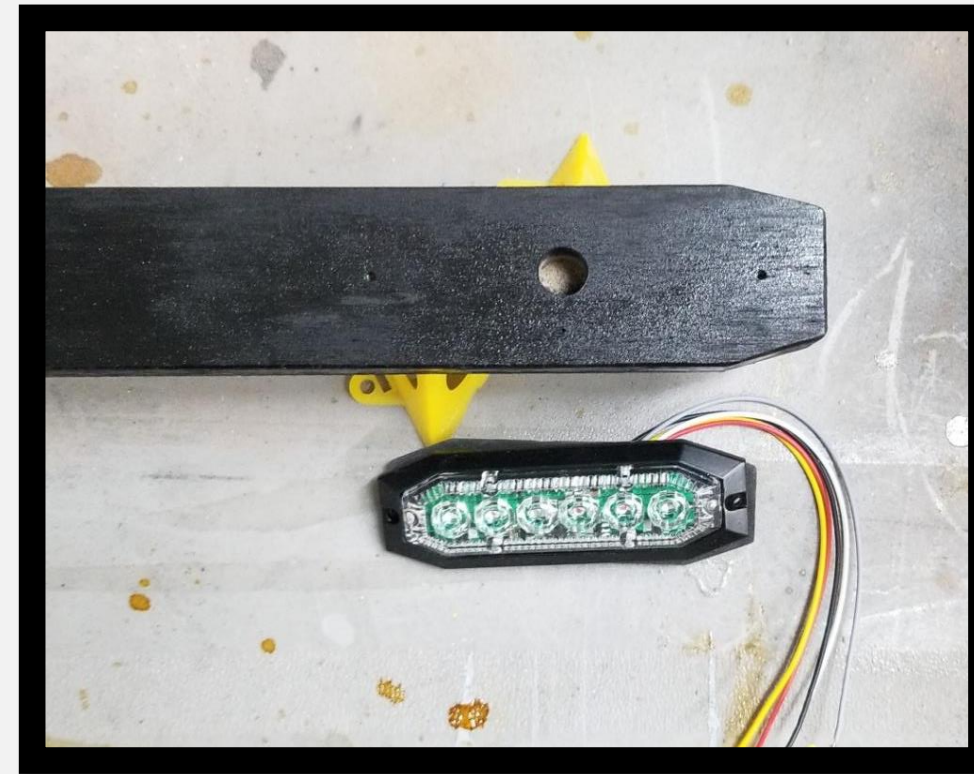

FINAL DESIGN



LOOKING AHEAD...



- I What design changes would we make?
- I What would we like to see in next years team?
- I Additional suggestions

IN CONCLUSION

- I Background: Lack of cautionary lights for pedestrians
- I Solution: lighting system that is independently powered, mobile and powers flashing lights
- I What we accomplished