

AQUATIC WEED REMOVAL

DESIGN REPORT

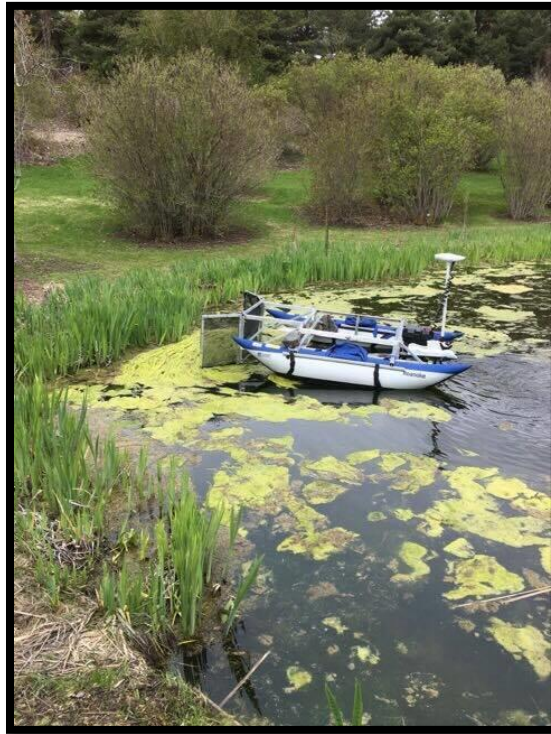

Bryan Barrett - barr3834@vandals.uidaho.edu

Nicole Fletcher - flet7375@vandals.uidaho.edu

Autumn Pratt - prat1125@vandals.uidaho.edu

Stephen Walters - walt0844@vandals.uidaho.edu

Sarah Willis - will9753@vandals.uidaho.edu

TABLE OF CONTENTS:

Executive Summary -----	3
Background -----	3
Problem Definition -----	4
Project Plan -----	5
Concepts Considered -----	6
Concept Selection -----	14
System Architecture -----	15
Design Evaluation -----	20
Future Work -----	22
Appendices	
Appendix A --- Schedules -----	24
Appendix B --- Calculations -----	27
Appendix C --- Test Data -----	53
Appendix D --- Owners Manuals/Data Sheets -----	56
Appendix E --- PFMEA -----	80
Appendix F --- Accounting -----	81

► EXECUTIVE SUMMARY

Team Nemo designed a small-scale weed harvesting boat to clear the arboretum pond. The arboretum caretakers need a solution to the aquatic weed overgrowth problem which will reduce man-hours spent on pond maintenance and keep the weeds at manageable levels. Any solution must be lightweight and maneuverable enough to be manageable by one or two people, and be safe and unobtrusive enough for use in the park-like situation.

The boat designed has no components over 60 pounds, and can reasonably be managed by a single worker. Its scale is suitable for navigating the small ponds, its safety is similar to that of a lawnmower, and the electric trolling motor provides quiet propulsion. Its use in the arboretum will only be noticed by guests as an interesting novelty, and it will provide caretakers a reliable tool for clearing the pond.

Initial tests have shown that the boat effectively clears weeds. There are still suggested modifications which could be made next fall, but even without them the boat should be useful over the summer. Based on our conversations with others during the project, weed overgrowth in small ponds is a common issue, and ideas from our design could potentially be used to create a marketable “pond-mower”.

► BACKGROUND

For the past few years the ponds in the University of Idaho Arboretum have been carpeted with duckweed, algae, and *Azolla*. The caretakers have made many ineffective attempts to clear the ponds, which have been time consuming, expensive, and ecosystem disruptive.

This weed harvesting boat has been commissioned to address the overgrowth. It will provide caretakers the ability to cut back growth immediately, and by removing biomass it will reduce the nutrient overload which is causing the problem. Similar commercially available machines are much larger and have no remote control option. Our boat will better suit the scale and needs of the arboretum, and be a better value financially. It will save the caretakers time, and help restore a healthy pond to the arboretum’s supporters.

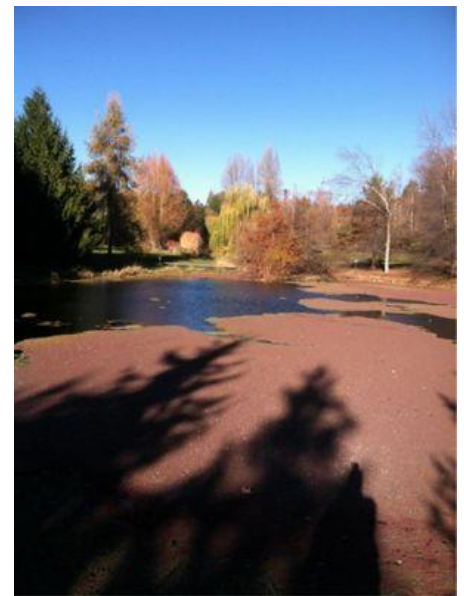

Figure 1 Pond Carpeted with Azolla

Selection of Past Attempts

	<i>Attempt</i>	<i>Type</i>	<i>Explanation/Cause of Failure</i>
1	<i>Aquatic Herbicide</i>	<i>Chemical</i>	<i>Weed decomposition suffocated fish</i>
2	<i>Proskim Skimmer</i>	<i>Mechanical</i>	<i>Clogged on feathers/snail shells</i>
3	<i>Aluminum Sulfate</i>	<i>Chemical</i>	<i>Unusable due to high pond pH</i>
4	<i>Grass Carp</i>	<i>Biological</i>	<i>Unable to keep up weed growth</i>
5	<i>Aeration</i>	<i>Environmental</i>	<i>Seemed to help, but insufficient</i>

► PROBLEM DEFINITION

The weed reduction problem was given to us open ended, with possible solutions ranging from mechanical to biological. Our goal was simply to reduce the weed growth to a reasonable level, which we defined as 10% pond coverage or less. We were requested deliver whatever hardware and instructions were necessary for the arboretum caretakers to carry out our plan over the summer. The following requirements were important to our client in order for an attempt to be considered successful.

Specifications & Constraints			
	<i>Specification</i>	<i>Specific Requirements</i>	<i>Target Values</i>
1	<i>Labor</i>	<i>Low operator hours</i>	<i>≤ 8 man-hours per week</i>
2	<i>Maneuverability (1)</i>	<i>Weight</i>	<i>No component more than 100 lb.</i>
3	<i>Maneuverability (2)</i>	<i>Length</i>	<i>Under 12 ft. long</i>
4	<i>Cost</i>	<i>Budget</i>	<i>Under \$15,000</i>
5	<i>Safety</i>	<i>Safe for operator</i>	<i>Negligible risk with proper operation</i>

After we decided to narrow our focus to mechanical harvesting by boat, we added the following features to our list of goals. The final deliverable is a prototype of the boat and attachments. An on-shore conveyor will be suggested, but not ordered, since it is a stand-alone piece.

Goal Features for Boat			
	<i>Feature</i>	<i>Specification</i>	<i>Target Value</i>
1	<i>Boat Body</i>	<i>Cost</i>	<i>≤ \$1,500</i>
2	<i>Plow</i>	<i>Width</i>	<i>At least 6 ft.</i>
3		<i>Material</i>	<i>Water permeable, holes ≤ 1/8"</i>
4		<i>Cost</i>	<i>≤ \$1,000</i>
5	<i>Conveyor</i>	<i>Width</i>	<i>3-4 ft.</i>
6		<i>Material</i>	<i>Water permeable, gripping surface</i>
7		<i>Cost</i>	<i>≤ \$2,000</i>
8	<i>Control system</i>	<i>Remote Control</i>	<i>Workable range for pond (≈ 150 - 300 ft.)</i>
10	<i>Battery</i>	<i>Life</i>	<i>At least 8 hours run time</i>
11	<i>Complete Power/Drive System</i>	<i>Cost</i>	<i>≤ \$1,000</i>

► **PROJECT PLAN**

◆ *Team Roles, Responsibilities, and Specializations*

Organizational Responsibilities			
	<i>Responsibility</i>	<i>Member</i>	<i>Explanation</i>
1	<i>Budget</i>	<i>S. Walters</i>	<i>Keep track of expenses</i>
2	<i>Primary Client Contact</i>	<i>B. Barrett</i>	<i>Regular communication, documentation</i>
3	<i>Meeting/workflow organizer</i>	<i>A. Pratt</i>	<i>Planning, schedules, agendas, wikipage</i>
4	<i>Documentation</i>	<i>S. Willis</i>	<i>Portfolio, meeting minutes</i>

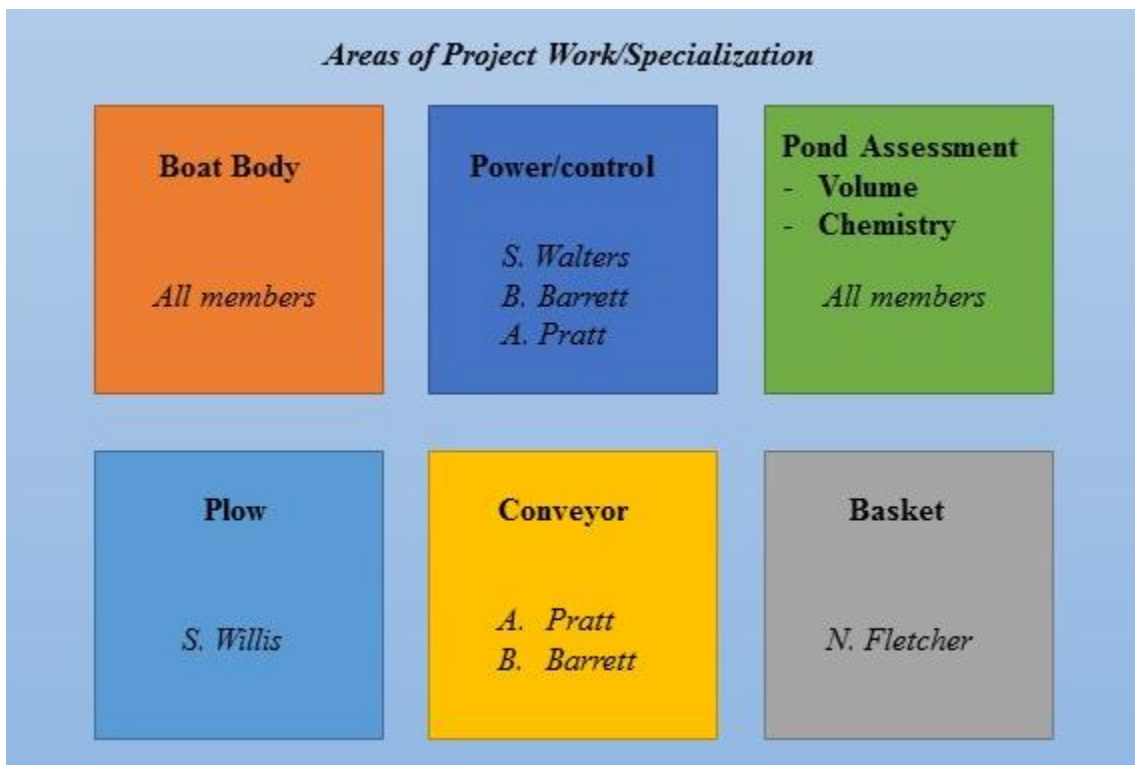

Figure 2 Specializations in Project Work

◆ *Scheduling – Also See Gantt Chart (Appendix A.)*

Our plan was to spend the first semester researching, taking measurements on the pond, brainstorming, and choosing a solution. The second semester would be used for detailed design and construction. Please see the Gantt chart in Appendix A. The green bars show the time frames of our original plan, and the orange show

delays. (The Gantt chart is a composite of our first and second semester schedules – obviously, we did not know the specifics of what we would be constructing until the end of the first semester).

As can be seen from the chart, we ended up with most of our work in the second semester and began to build up delays. It would have been better to settle on a clear idea of our solution earlier, rather than going into such depth in researching the variety of solutions.

► CONCEPTS CONSIDERED

◆ *Overview*

Figure 3 summarizes our design process. Near the end of the first semester we presented our client with a range of mechanical, chemical, environmental, and biological solutions. With the clients input, we chose to build a boat which could be fitted with either plow or conveyor attachments, and could also be furnished with remote control. The idea was modelled off of larger commercially available weed harvesting boats.

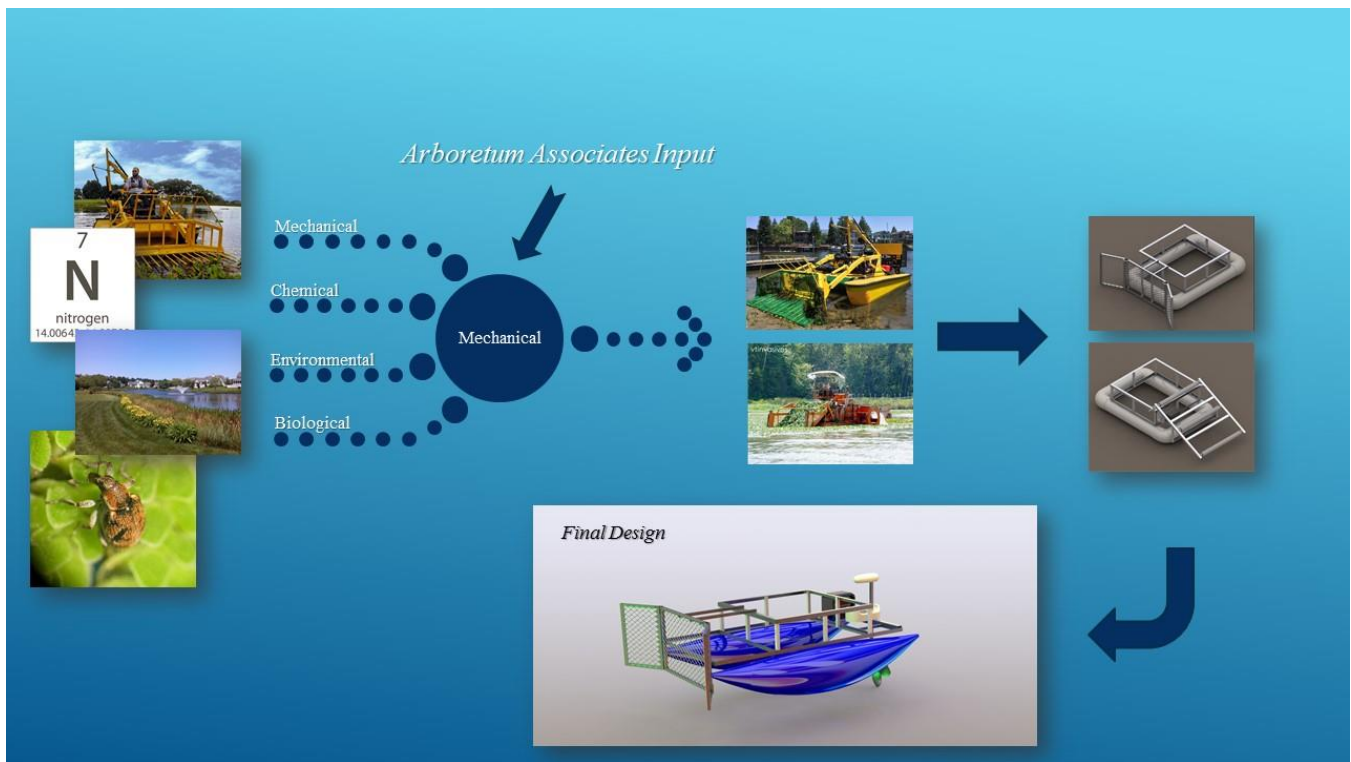









Figure 3 Summary of Design Process.

◆ *Original Possibilities – Details and Supporting Data*



The following are ideas which we considered in the initial phase of our project.

Original Possibilities Considered				
	<i>Possibility</i>	<i>Type</i>	<i>Explanation /Supporting Data</i>	<i>Estimated Cost</i>
1	 <p><i>Remote Controlled Water Plow</i></p>	<i>Mechanical</i>	<i>Remote controlled plow pushes weeds to shore – suggested for use with onshore conveyor. Concept proven by Weedo boats.</i>	<i>\$ 600</i>
2	 <p><i>Remote Controlled Conveyor Collection</i></p>		<i>Remote controlled conveyor collects weeds on boat. Weed collection basket 1/3 submerged so that weeds support their own weight (Based on Azolla density - see Appendix B. for measurements and calculations.)</i>	<i>\$ 1,000</i>
3	 <p><i>Manned Version Plow/Conveyor</i></p>		<i>Manned version of either plow or conveyor concept.</i>	<i>\$1,000-\$5,000</i>
4	 <p><i>Nitrate Addition</i></p>	<i>Chemical</i>	<i>Azolla has a competitive advantage when nitrate to phosphate ratios are low. If the dissolved inorganic nitrate to phosphate ratio is less than 10:1, Azolla likely has the competitive advantage. Adding nitrate may help rebalance the system. (Consultant: Dr. Wilhelm, UI College of Natural Resources. See Appendix C for chemical test results.)</i>	<i>\$ 415 / ton</i>



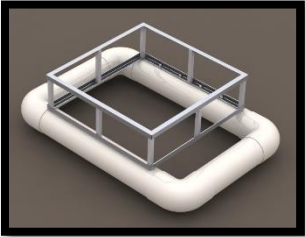

5	 <p>Buffer Zone</p>	<i>Environmental</i>	<i>Buffer zones are a well-documented method of controlling sediment and nutrient inputs to ponds. A buffer could be a simple strip of long grass, or another flowering display for the arboretum.</i>	\$ 0-\$ 200
6	 <p>Partial Pre-rain Drain</p>		<i>Partially draining the pond before expected rains would help dilute the nutrient heavy water. Rather than mostly pure rain water overflowing, draining beforehand would flush the settled water. This could refresh up to 80% of the ponds' water yearly. (See Appendix B for calculations.)</i>	\$ 0
7	 <p>Added Aeration</p>		<i>Adding aeration increases the dissolved oxygen in the bottom of the pond, encouraging aerobic bacteria which break down organic material and reduce phosphorus concentration. This reduces weed growth and pond stench.</i>	\$ 1,000- \$ 2,000
8	 <p>Azolla Weevil</p>	<i>Biological</i>	<i>The Stenopelmus rufinasus beetle (Azolla Weevil) feeds on Azolla. Adding a natural predator such as the weevil could cut back on at least the Azolla growth with no additional caretaker work.</i>	<i>(Research was not continued due to concerns about introducing new species)</i>

◆ *Boat Specific – Details and Supporting Data*





The following are possibilities we considered after deciding that our solution would be a harvesting boat. They are organized by assembly: boat body, plow, conveyor, and motor/controls.



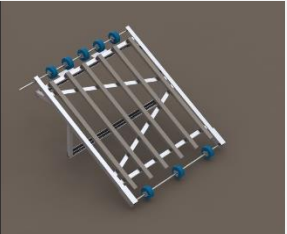

Boat Body Possibilities			
	<i>Possibility</i>	<i>Explanation /Supporting Data</i>	<i>Part of Final Solution?</i>
1	 <p><i>Fiberglass Hull</i></p>	<p><i>(Constructed with fiberglass paint) Customizable, lightweight, weather-resistant, could be difficult to work with</i></p>	
2	 <p><i>PVC Pontoons</i></p>	<p><i>Weather-resistant, strong, come in standard sizes, difficult to assemble, heavy. See Appendix B for calculations of weight to buoyancy.</i></p>	
3	 <p><i>Inflatable Pontoons</i></p>	<p><i>Weather-resistant, lightweight, relatively cheap, locally available</i></p>	X

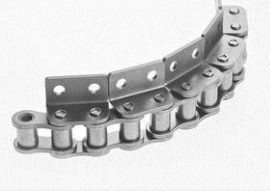
Plow Possibilities



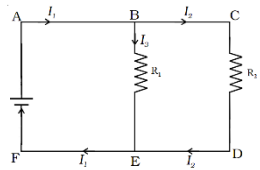

	<i>Possibility</i>	<i>Explanation /Supporting Data</i>	<i>Part of Final Solution?</i>
1	 <p><i>Plastic Frame</i></p>	<p><i>Lightweight, weather-resistant, low strength, complex connections with aluminum boat</i></p>	
2	 <p><i>Aluminum Frame</i></p>	<p><i>Lightweight, weather-resistant, strong</i></p>	X
3	 <p><i>Plastic Mesh Netting</i></p>	<p><i>Weather-resistant, holes larger than optimal (goal: 1/8" holes)</i></p>	
4	 <p><i>Metal Mesh Netting</i></p>	<p><i>Strong, corrosion may be an issue, heavy</i></p>	
5	 <p><i>Screen Door Material Netting</i></p>	<p><i>Lightweight, weather-resistant, easy to work with</i></p>	X

Conveyor Possibilities

	<i>Possibility</i>	<i>Explanation /Supporting Data</i>	<i>Part of Final Solution?</i>
1	 <p>Full-Assembly Purchase</p>	<p><i>(Purchase complete conveyor belt from supplier) Extremely heavy, corrosion a concern, connections difficult</i></p>	
2	 <p>Aluminum Frame</p>	<p><i>Lightweight, weather-resistant, connections to boat frame simple</i></p>	X
3	 <p>Manufactured Belt Purchase – Positive Drive</p>	<p><i>Weather-resistant, no need for corrosion-prone chain, reliable, customizable, reasonable weight, expensive.</i></p>	X
4	 <p>Constructed Belt – Chain Drive</p>	<p><i>Inexpensive (belt likely made of trampoline material), chain prone to corrosion, difficult to add cleats to surface, difficult to assemble</i></p>	
5	 <p>Constructed Belt – Timing Belt Drive</p>	<p><i>Inexpensive (belt likely made of trampoline material), difficult to add cleats to surface, difficult to assemble, lengths must be exact</i></p>	

6	 <p>Motor – Built in Rod</p>	<p><i>Simple, heavy, very expensive, not weather-resistant</i></p>	
7	 <p>Motor – Chain Connection</p>	<p><i>Inexpensive, easy to replace, lightweight</i></p>	X
8	 <p>Speed Control – Complete Scooter System</p>	<p><i>(Parts from the same electric scooter the motor came from.) Parts guaranteed compatible, includes unnecessary features</i></p>	
9	 <p>Speed Control – Voltage Lowering</p>	<p><i>(Simply splitting voltage to motor rather than using Pulse Width Modulation like most speed controllers.) Simple, wastes power</i></p>	
10	 <p>Speed Control – Separate Speed Controller</p>	<p><i>Simple, inexpensive, does not waste power, needs waterproofing</i></p>	X

Motor/Control Possibilities

	<i>Possibility</i>	<i>Explanation /Supporting Data</i>	<i>Part of Final Solution?</i>
1	 <p>Gas Motor</p>	<p><i>Doesn't need to charge, noisy, more difficult to convert to remote control</i></p>	
2	 <p>Remote Control Model Motor</p>	<p><i>Easy to work with, undersized for our application</i></p>	
3	 <p>2 Simple Motors with Purchased Remote Control System</p>	<p><i>(Having 2 motors enables steering without rotation ability) Easy to integrate remote connection with conveyor controls, difficult to waterproof, some electronic assembly required, difficult to size correctly</i></p>	
4	 <p>Remote Control Trolling Motor</p>	<p><i>Easy to size, no electronic assembly required, range unreliable (purportedly 100ft, when purchased and tested was found to be about 50 ft.)</i></p>	X
5	 <p>Convert Manual Trolling Motor</p>	<p><i>Easy to size, difficult to construct steering mechanism, difficult to create electronics/remote control system.</i></p>	

► **CONCEPT SELECTION**

As shown in figure 3 (beginning of *Concepts Considered* section), we chose to pursue a mechanical solution based on the interests of our client. The remote control aspect appealed to them, and they liked both the plow and conveyor. We decided to construct a boat which could support either a plow or conveyor attachment, so both could be tested. Our theory is the two options will complement each other: the collection method will be more useful for low-density growth, while the plow will be more effective for an overgrown pond.

Our decisions about the specifics of boat construction were based off of time required for construction, cost, and suitability for function. The following table summarizes the reasoning behind our decisions. Each possibility is rated for time, cost, and suitability. The possibility with the highest sum of ratings is the best.

Choosing Final Design (Scale 1-4 for Each Rating)										
	<i>Function</i>	<i>Option 1</i>			<i>Option 2</i>			<i>Option 3</i>		
		<u>Time</u>	<u>\$\$</u>	<u>Suitability</u>	<u>Time</u>	<u>\$\$</u>	<u>Suitability</u>	<u>Time</u>	<u>\$\$</u>	<u>Suitability</u>
1	<i>Floatation</i>	<i>Fiberglass</i>			<i>PVC</i>			<i>Inflatable Pontoon</i>		
		1+3+1=5			2+2+2=6			4+3+4=11		
2	<i>Plow Frame</i>	<i>Plastic</i>			<i>Aluminum</i>					
		2+3+2=7			3+3+4=10					
3	<i>Plow Netting</i>	<i>Plastic</i>			<i>Metal</i>			<i>Screen Door (Anthracite Carbon)</i>		
		2+4+1=7			1+2+2=5			3+3+3=9		
4	<i>Conveyor Frame</i>	<i>Full-Assembly Purchase</i>			<i>Aluminum Frame</i>					
		4+1+1=6			3+4+3=10					
5	<i>Conveyor Belt</i>	<i>Purchased Positive Drive</i>			<i>Chain Drive</i>			<i>Timing Belt Drive</i>		
		4+1+4=9			1+3+1=5			1+3+2=6		
6	<i>Conveyor Motor</i>	<i>Built in Rod</i>			<i>Chain Connection</i>					
		3+1+1=5			3+4+2=9					
7	<i>Conveyor Speed Control</i>	<i>Scooter System</i>			<i>Voltage Lowering</i>			<i>Separate Speed Controller</i>		
		2+2+2=6			2+3+1=6			4+4+3=11		
8	<i>Motor Power Source</i>	<i>Gas</i>			<i>Electric</i>					
		2+2+2=6			3+3+3=9					
9	<i>Motor Type</i>	<i>Trolling</i>			<i>Hobby</i>					
		3+3+4=10			2+4+3=9					
10	<i>Trolling Motor RC Type</i>	<i>Built-in (purchased)</i>			<i>Converted</i>					
		3+2+3=8			2+3+2=7					

The decision between PVC and inflatable pontoons was an exception to our normal design process. We did not think of the inflatable pontoons in our initial design phase, and were in the process of constructing with the PVC before we realized that the inflatable pontoons were a much better solution. While it was frustrating to backtrack on our design, we think that the client will find the change worthwhile. The final product is much lighter, more robust, and easier to disassemble for storage.

The decisions for the conveyor were also a little complicated. We wanted to use professionally made parts to make sure our product was good quality, but most conveyor belts are not designed for lightweight applications. Additionally, conveyor belts are often designed as full systems, which makes mixing and matching parts difficult. We settled on building our own frame and power system and buying a professionally made belt.

► SYSTEM ARCHITECTURE

◆ *Boat Body*

The boat body is lightweight, made of weather-resistant materials, and provides more than sufficient buoyancy for the power system and either of the attachments (plow or conveyor). In fact, it can easily support a person on-board if desired. The frame is made of 6061 Aluminum, chosen for its corrosion resistance and weldability. Most joints are welded – removable connections are fastened with hex bolts.

The rectangular connections (see figure 4) to the pontoons are important to keep the pontoons from rolling. The pontoons are secured to them with straps, which are easily removable if desired for storage. The pontoons themselves can be deflated (adaptors provided in supplies).

A battery box is bolted to the back of the frame to keep the battery dry and secure. (Figure 5) The motor also connects to the back shelf.

The attachments are held on with easily removable cotter pins (figure 6), and a lower support bar (figure 7). The lower support bar has two positions, also adjustable with cotter pins. The front position is for the plow attachment, the back position is for the conveyor attachment.



Figure 4 Boat Body

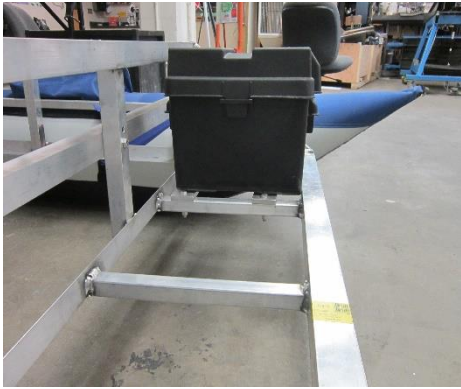

Figure 5 Battery Box and Back Shelf



Figure 6 Cotter Pins



Figure 7 Lower Support Bar

Boat Body Satisfaction of Requirements

	<i>Requirement</i>	<i>Achieved Value</i>	<i>Target Values</i>	<i>Satisfied?</i>
1	<i>Cost</i>	\$1,069.09	≤ \$1,500 (of \$15,000)	X
2	<i>Weight</i>	48 lb.	≤ 100 lb.	X
3	<i>Length</i>	8 ft. (w/plow ~10ft)	Under 12 ft. long	X
4	<i>Assembly Time *</i>	15-20 man-hours	≤ 40 man-hours	X

* Assembly time does not include dead-end ideas, only the final configuration assembly. Breakdown of time can be found in Appendix A.

◆ Plow

The plow is lightweight, and made of weather-resistant aluminum. The screen is made of anthracite carbon (commonly used for screen doors), which is strong and durable. The small holes catch even granular weeds like *Azolla* while allowing water to pass through, decreasing side currents and drag. See figure 8.

The side panels of the plow are adjustable so that the width can be changed. The hinge mechanism is shown in figure 9. The net is attached



Figure 8 Plow Attachment



Figure 9 Plow Adjustment Hinge

using grommets and zip ties for easy removal in case of puncture. (The net is the sacrificial part if the plow encounters any sharp obstacles.)

Plow Satisfaction of Requirements				
	<i>Requirement</i>	<i>Achieved Value</i>	<i>Target Values</i>	<i>Satisfied?</i>
1	<i>Cost</i>	\$254.46	$\leq \$1,000$ (of \$15,000)	X
2	<i>Weight</i>	10 lb.	≤ 100 lb.	X
3	<i>Assembly Time</i>	25-30 man-hours	≤ 30 man-hours	X

◆ *Conveyor*

The conveyor is much lighter than its commercially available counterparts. Its frame is made of 6061 Aluminum with stainless steel fasteners. Most of the joints are fastened with lock nuts rather than welded, so modifications remain possible. The “arms” of the conveyor (connections to boat) especially must be removable in order to be able to slide the belt onto the frame without separating it. The square aluminum tubes which run the length of the conveyor frame are wear-strips. (See figure 10.) They provide support to the belt, as suggested by our belt supplier. The frame also includes separate end pieces to adjust tension – however, tension should be kept low for this belt, which is designed to run loosely.



Figure 10 Conveyor Frame

We chose to use S10 modular belt from Forbo, with corresponding sprockets. See Appendix D for datasheet. The modular belt is positive drive, meaning that the sprockets hook directly into grooves and ridges in the underside of the belt rather than to a chain system. (Figure 10 shows the underside of the belt and a sprocket.) S10 belt is one of the lightest weight options for Forbo belting, and comes with a variety of different surfaces, from knobbed to slotted to finned. (Figure 11 shows to top side of the belt with a variety of different surfaces.) We chose a pattern of modules which included nubs for weed grip, 22% open slots for drainage, and fin profiles to keep weeds from sliding back down the belt. (Figure 12 shows pattern.)



Figure 11 Underside of Belt, with Sprocket



Figure 12 Top Side of Belt

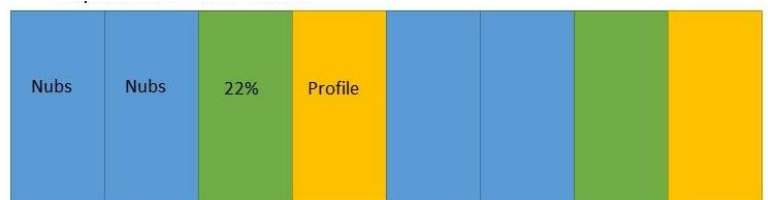

Figure 13 Surface Pattern

Calculations to check belt strength and find required power and torque were based on a conveyor design handbook which Forbo sent us. The handbook is included with our calculations in Appendix B. With our low expected load we found the power requirement to be 15 Watts for normal operation, with an estimated required torque of 2 Nm. To meet this need we chose a 12 V 100 W electric scooter motor which can be run off of the boat battery. We used a gear ratio of 9:1 to adjust the torque, and included a speed controller to bring the belt speed down to a desired level. We suggest 65 feet per minute, as it is a standard for conveyor belts. (The drive components are shown in figure 14.) The speed controller and motor are held in a sealable container with 3D printed supports. This should keep them safe from water damage in normal operation, but the motor box should never be submerged.

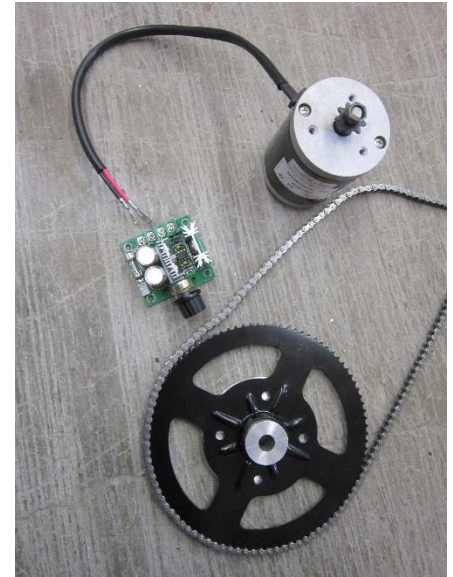

Figure 14 Conveyor Drive Components – Large Sprocket Includes Machined Connection Piece Because of Non-standard Threading

Conveyor Satisfaction of Requirements				
	<i>Requirement</i>	<i>Achieved Value</i>	<i>Target Values</i>	<i>Satisfied?</i>
1	<i>Cost</i>	<i>\$1,450.29</i>	<i>≤ \$2,000 (of \$15,000)</i>	X
2	<i>Weight</i>	<i>52 lb.</i>	<i>≤ 100 lb.</i>	X
3	<i>Assembly Time</i>	<i>35-40 man-hours</i>	<i>≤ 40 man-hours</i>	X

◆ *Motor/Control*

The boat is outfitted with a 55 lb., 12V Haswing Cayman trolling motor, shown in figure 15. (Owner’s manual included in Appendix D.) This motor should provide far more thrust than the boat will normally need based on size. The battery is deep cycle. Battery life is estimated as following (calculations in Appendix B):

Battery Life			
	<i>Low Speed</i>	<i>Medium Speed</i>	<i>High Speed</i>
1	<i>11-12 hrs.</i>	<i>3 hrs.</i>	<i>1.5 hrs.</i>

Since we assume that the boat will be operated between low and medium speed at most times, this seems sufficient. If a longer life is desired the battery can be easily upgraded.

The Haswing motor has a built in remote control system which controls speed and direction. In our tests the range seems to be 30-50 ft. (as opposed to the advertised 150 ft.) Because of this the current prototype of the boat is effective for testing the remote control concept, but should probably be driven from on board until the range is extended. (Figure 16 shows the current controller.) Since the pontoons are able to support so much extra weight,

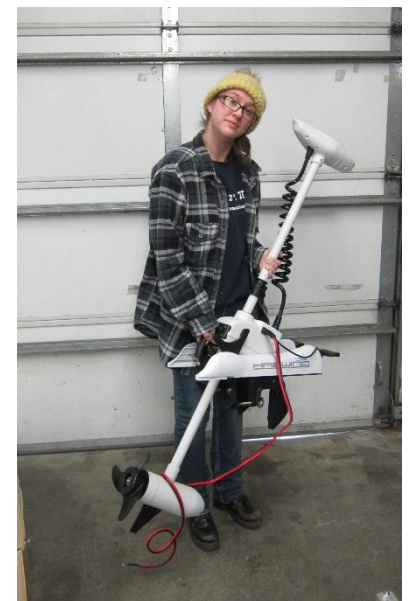

Figure 15 Haswing Cayman Trolling Motor

having the pilot ride the boat is a perfectly workable solution for the time being. We simply added the seat which came with the pontoons.

Motor/Control Satisfaction of Requirements				
	<i>Requirement</i>	<i>Achieved Value</i>	<i>Target Values</i>	<i>Satisfied?</i>
1	<i>Cost</i>	\$529.99	≤ \$1,000 (of \$15,000)	X
2	<i>Weight</i>	Battery 45lb, Motor 32 lb.	≤ 100 lb.	X
3	<i>Range</i>	50 ft.	150 – 300 ft.	---
4	<i>Assembly Time</i>	2 man-hours	≤ 40 man-hours	X

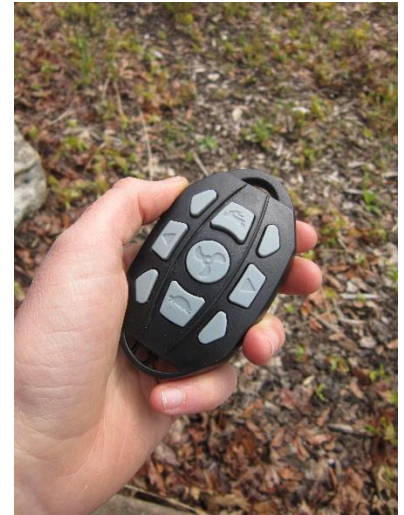

Figure 16 Motor Remote

◆ Suggested Onshore Conveyor

Since it is a stand-alone item, we did not actually purchase the on-shore conveyor. We think it may be helpful for use with the plow, but thought it was best to leave the arboretum to make the investment after the caretakers have a feel for how they will use the boat.

A summary of the features of the suggested conveyor is included in the table below. Of course, we recommend that it be compared with current needs before purchase.

This conveyor is model number PC-7-12 from Bastian Solutions. Since shipping is expensive for the full conveyor, checking for local used equipment at the time of purchase might be a good idea.

Onshore Conveyor Features		
	<i>Specification</i>	<i>Value</i>
1	<i>Cost</i>	\$2,528.60 + shipping (about \$1,500)
2	<i>Overall length</i>	7 ft.
3	<i>Overall width</i>	12 in
4	<i>Belt width</i>	8 in
5	<i>Standard speed</i>	65 feet per min
6	<i>Weight</i>	451 lb.



Figure 17 Suggested Onshore Conveyor Belt

◆ *Summary - Combined Systems Satisfaction of Original Design Requirements*

Although we did not meet one of our boat-specific requirements (full remote control range), we did meet all the original/overarching design requirements by adding the ability for the boat to carry a pilot.

Specifications & Constraints				
	<i>Specification</i>	<i>Specific Requirements</i>	<i>Target Values</i>	<i>Satisfied?</i>
1	<i>Labor</i>	<i>Low operator hours</i>	<i>≤ 8 man-hours per week</i>	X
2	<i>Maneuverability (1)</i>	<i>Weight</i>	<i>No component more than 100 lb.</i>	X
3	<i>Maneuverability (2)</i>	<i>Length</i>	<i>Under 12 ft. long</i>	X
4	<i>Cost</i>	<i>Budget</i>	<i>Under \$15,000</i>	X
5	<i>Safety</i>	<i>Safe for operator</i>	<i>Negligible risk with proper operation</i>	X

► **DESIGN EVALUATION**

◆ *PFMEA Evaluation*

Our final design fulfills the specifications and constraints, and addresses major failure risks. Some of these are highlighted in our PFMEA worksheet (see Appendix E.) The inflatable pontoons lessen the risk of leakage, as they are more durable and repairable than older floatation ideas. To address the risk of frame failure we decided to have the frame professionally welded, though we had initially planned to do it ourselves. The result is a sturdy boat which can be carried, dragged, and sat on without damage.

◆ *Testing & Results*

We ran a full-system test with the plow attachment in the upper arboretum pond. We first tested the remote control and maneuverability of the boat, then tested plow operation while unmanned, and finally tested operation with an on-board pilot. It was too early in the spring for full weed coverage, but there were scattered clumps of algae in the pond. The boat performed well at bringing them to shore. Details can be found in the following table.

Test Results		
	Area	Star Rating (1-4) and Notes
1	Maneuverability	◆◆◆◆ Good maneuverability. Managing direction is a bit of a learning curve, but that is true of most boats.
2	Remote Control	◆◆ Control was good within expected range. When signal was lost it was generally not too hard to pick up again. Having the remote eased on-board operation as well.
3	Weed Collection	◆◆◆◆ The plow performed perfectly. Note: a wider plow would not be difficult for the motor to push, and would make work more efficient.
4	General – Unmanned Operation	◆◆◆◆ Other than range, the boat performed well. Note: when boat is operated without an on-board pilot, weights (~75lb) should be added to the front of the boat to maintain balance.
5	General – Manned Operation	◆◆◆◆ When manned, the boat performs consistently and can reach all parts of the pond. The seat can simply be set across the frame. It can be strapped on if desired, though the set-up is sturdy even without straps. The weight of the operator balances the weight of the battery and motor, so front weights are unnecessary.

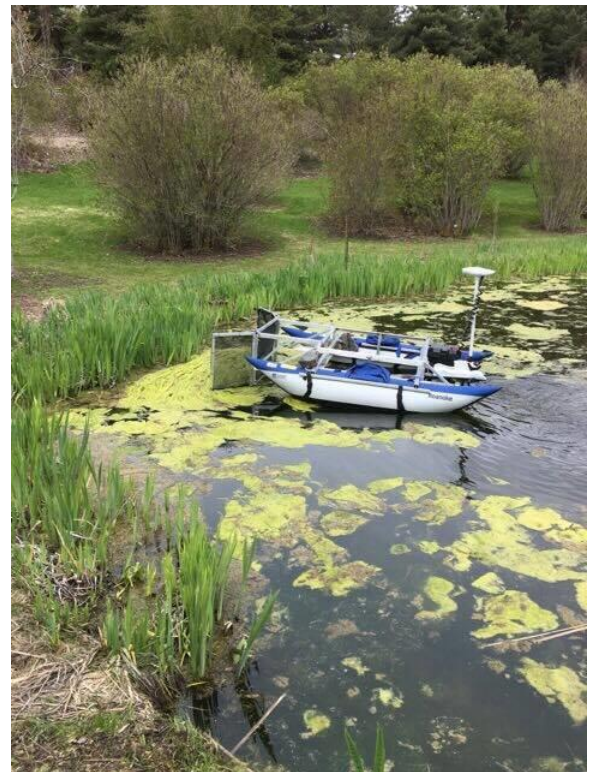

Figure 18 Testing Boat With and Without Onboard Operator

Overall we are pleased with the results of the test. With the addition of an on-board operator, the plowing boat is fully serviceable for work this summer. We plan to widen the plow before delivering the boat to the arboretum caretakers.

◆ **Budget Summary (Also See Appendix F)**

Our total expenditures come to \$4,181.74. There may be a few small purchases made as we prepare to deliver the boat the arboretum, but this amount is representative. Of this amount \$3,378.95 was spent on the current design, with the remaining \$802.79 on chemical testing, earlier iterations, and other supplies. (Full accounting is in Appendix F.) We regret that we did not foresee the problems with earlier iterations, but we are happy to have left most of the \$15,000 budget for future improvements.

► **FUTURE WORK**

The conveyor belt attachment still needs to be tested. We anticipate doing this before we end our portion of the project. Ideas for its modification can be saved for future groups.

Our motor currently has a remote control range of 30-50 ft. Until more work can be done, we suggest setting up the seat and driving the boat from on-board when trying to reach the middle of the pond. The conveyor belt is less convenient to use while riding the boat than the plow is – because of this the conveyor should mostly be used around the edge of the pond where a rider is not necessary.

Simply adding an antenna to the current controller would be a possibility, but would not take care of the conveyor controls. Though we would not advise this route, we want to pass on the information that the motor distributor suggested a 433 MHz 5-6 dB antenna. If it is not important to the user to be able to turn the conveyor on and off remotely, an antenna may be a fine solution. In that case all that remains is to verify the specifications for the antenna and figure out how to connect it.

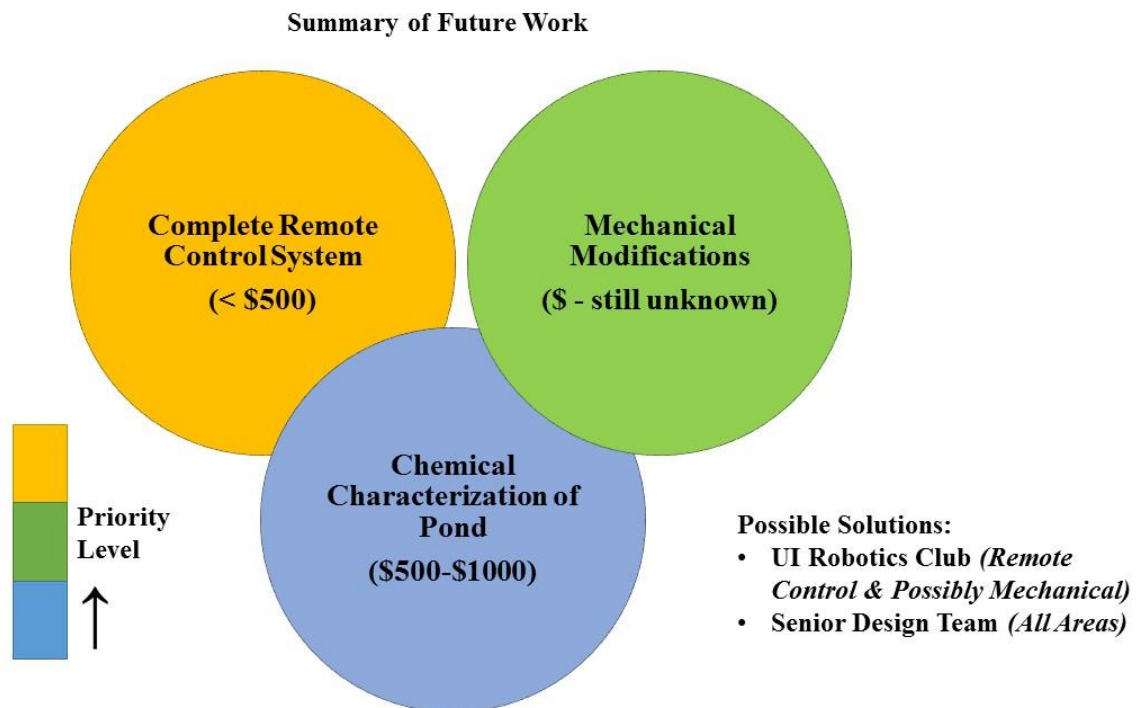

Figure 19 Future Work

If remote control of the conveyor is still considered important for safety reasons, a longer range remote system needs to be constructed which integrates the controls for the on-board conveyor belt with the controls for the motor. We decided not to pursue this in the time constraints we had because we thought it should be done thoroughly and robustly. Attempting to adapt the motor without enough time to do it properly risked breaking it. We estimate that design and construction of a robust remote control system would be sufficient senior design work for one student, and would cost less than \$500. Over the summer the arboretum caretakers will probably also discover mechanical features they would like modified. If they do, mechanical modifications could be combined with the remote control system design to create a design team project. Another possibility would be to contact the University of Idaho Robotics Club. They might enjoy taking on the remote control system design, as it would be good electronics practice.

If a future team takes up the project, we think it might also be wise to monitor the nutrient levels in the pond, and begin to build up a better understanding of the affecting factors. Another way to broaden the project would be to consider the possibility of wider application – would a small scale “pond-mower” or weed clearing attachments for a normal boat be something that other landowners would find useful?

► APPENDICES

► APPENDIX A –SCHEDULES

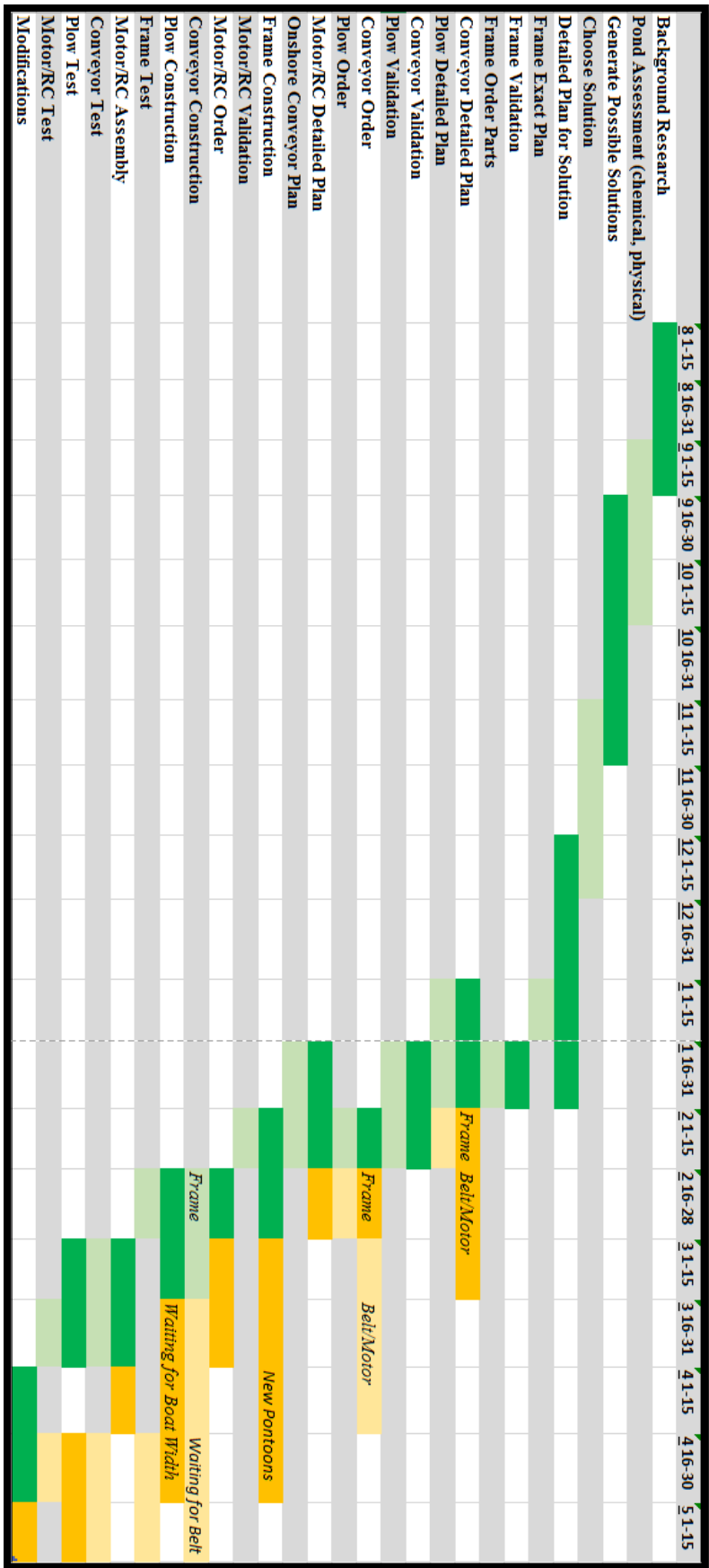

◆ Detailed Spring Schedule (Planned)

DECEMBER 2016						FEBRUARY 2017					
S	M	T	W	T	F	S	M	T	W	T	F
						1	2	3	4		
4	5	6	7	8	9	10	11	12	13	14	15
11	12	13	14	15	16	17	18	19	20	21	22
18	19	20	21	22	23	24	25	26	27	28	
25	26	27	28	29	30	31					

JANUARY 2017

SUNDAY	MONDAY	TUESDAY	WEDNESDAY	THURSDAY	FRIDAY	SATURDAY
New Year's Day						
8	9	10	11	12	13	14
				Frame Plan	Conveyor/Plow Plan	Frame Validation
15	16	17	18	19	20	21
M L King Day			Order Frame	★		
22	23	24	25	26	27	28
			Conveyor/Plow Validation	Motor/RC plan	(Onshore conveyor also?)	
29	30	31				

JANUARY 2017						MARCH 2017					
S	M	T	W	T	F	S	M	T	W	T	F
1	2	3	4	5	6	7	8	9	10	11	12
13	14	15	16	17	18	13	14	15	16	17	18
19	20	21	22	23	24	19	20	21	22	23	24
25	26	27	28	29	30	25	26	27	28	29	30
31											

FEBRUARY 2017

SUNDAY	MONDAY	TUESDAY	WEDNESDAY	THURSDAY	FRIDAY	SATURDAY
29	30	31	1	2	★	3
			Order Conveyor/Plow			
5	6	7	8	9	10	11
		Construct Frame				
12	13	14	15	16	17	18
		Valentine's Day		Order Motor/RC	★	
19	20	21	22	23	24	25
Presidents' Day	Frame Test					
Conveyor/Plow Construction						
26	27	28	1	2	3	4

FEBRUARY 2017						APRIL 2017					
S	M	T	W	T	F	S	M	T	W	T	F
1	2	3	4			1	2	3	4	5	6
5	6	7	8	9	10	7	8	9	10	11	12
12	13	14	15	16	17	13	14	15	16	17	18
18	19	20	21	22	23	19	20	21	22	23	24
24	25	26	27	28	29	25	26	27	28	29	30
30						30					

MARCH 2017

SUNDAY	MONDAY	TUESDAY	WEDNESDAY	THURSDAY	FRIDAY	SATURDAY
26	27	28	1	2	3	4
				Assemble Motor/RC		
5	6	7	8	9	10	11
					Test Conveyor/Plow	
12	13	14	15	16	17	18
Spring break						
19	20	21	22	23	24	25
				Test Motor/RC		
26	27	28	29	30	31	
				MODIFICATIONS		

MARCH 2017						MAY 2017					
S	M	T	W	T	F	S	M	T	W	T	F
1	2	3	4			1	2	3	4	5	6
5	6	7	8	9	10	7	8	9	10	11	12
12	13	14	15	16	17	13	14	15	16	17	18
18	19	20	21	22	23	19	20	21	22	23	24
24	25	26	27	28	29	25	26	27	28	29	30
30	31					30	31				

APRIL 2017

SUNDAY	MONDAY	TUESDAY	WEDNESDAY	THURSDAY	FRIDAY	SATURDAY
26	27	28	29	30	31	
2	3	4	5	6	7	8
MODIFICATIONS						
9	10	11	12	13	14	15
					Good Friday	
16	17	18	19	20	21	22
Easter Sunday						
23	24	25	26	27	28	29
					EXPO	
30	1	2	3	4	5	6

◆ *Breakdown of Estimated Assembly Times (For Final Design, Not Including Earlier Iterations)*

Estimated Assembly Time			
	Category	Task	Time (man-hours)
1	<i>Boat Body</i>	<i>Cutting Aluminum</i>	3
		<i>Welding Arrangements</i>	3
		<i>Drilling holes/adding fasteners</i>	4
		<i>Sewing Longer Straps</i>	5
		<i>Inflating, Strapping on, etc.</i>	1
		Total:	16 → 15-20 hours
2	<i>Plow</i>	<i>Cutting Aluminum</i>	1
		<i>Drilling Holes/Adding Fasteners</i>	3
		<i>Welding Arrangements</i>	2
		<i>Milling Hinge Mechanism</i>	8
		<i>Net Cutting/Sewing/Grommets</i>	12
		Total:	26 → 25-30 hours
3	<i>Conveyor</i>	<i>Cutting Aluminum</i>	6
		<i>Drilling Holes/adding fasteners</i>	8
		<i>Milling Set-Holes in Axels</i>	3
		<i>Milling Squares</i>	3
		<i>Machining Center Piece for Large Sprocket</i>	5
		<i>Tensioners</i>	1
		<i>Creating 3D Printed Motor Box Parts</i>	4
		<i>Connecting Motor Box, Adding Wiring</i>	2
		<i>Assemble Rods, Sprockets, Belt, and Align</i>	2
		Total:	36 → (35-40)
4	<i>Motor/Control</i>	<i>Assemble Motor, Connect to Boat</i>	2
		Total:	2

► APPENDIX B – CALCULATIONS & CODE

◆ *Azolla* Density

We could not find the density of *Azolla* online, so we measured it with the following procedure:

- Find mass of measuring cup.
- Measurement 1 (upper end density): lightly compress *Azolla*, measure volume and mass (remember to subtract mass of measuring cup.)
- Measurement 2 (lower end density): repeat, compressing *Azolla* little as possible.

* Note: The *Azolla* in the experiment was taken directly out of the water, to mimic the conditions in which we will be working with it. *Azolla* is very water repellent and does not change greatly in weight due to contact with water.

Density Test Results	
	Density
Test 1 (slightly compressed)	20 lb./ft ³
Test 2	17 lb./ft ³

◆ *Basket Submersion Necessary to Self-Support*

For the collected *Azolla* to be self-supporting in the water, the buoyant force of the submerged *Azolla* must equal the weight of the *Azolla* which is held out of the water. The force balance equation can be simply rearranged to find the heights involved in terms of the densities of *Azolla* and water. The result is that the height of the basket out of the water can be up to twice the height submerged – that is, we should plan on submerging 1/3 or more of the basket.

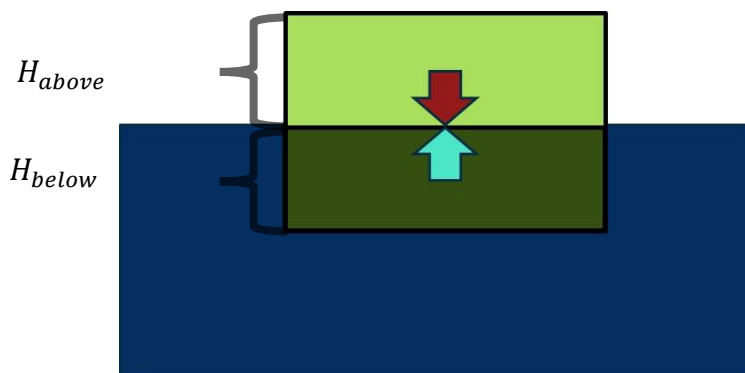

$$\frac{H_{above}}{H_{below}} = \frac{\rho_w - \rho_{az}}{\rho_{az}} \approx 2$$

◆ **Rainfall Calculations Supporting Pre-Rain Drain Idea**

The percentage of pond water which could be refreshed yearly through pre-rain draining was based off of the average rainfall for the Palouse (reported as 27” by US Climate Data) and our measurements for the area and volume of the ponds (see Appendix C.)

$$\text{Percentage} = \frac{(\text{Average Rainfall}) \times (\text{Surface Area of Ponds})}{\text{Volume of Ponds}} = 80\%$$

◆ **PVC Weight to Buoyancy Summary**

$$\text{Buoyancy} = (\text{Volume of Water Displaced}) \times (\text{Density of Water})$$

$$\text{Weight} = (\text{Length}) \times (\text{Weight per Length}) + \text{Weight of Elbows}$$

The picture below shows a summary of the buoyancy and boat weight for different boat sizes (reported be basket size because the basket was the size-defining feature.) The percentages listed in black are the percentages of the total available pontoon volume which would be submerged in a given boat design. As can be seen, the PVC is quite heavy and provides only barely enough buoyancy at the scale we are interested in. Reducing the size reduces the on-shore weight, but also reduces the buoyancy. Ideally the pontoons should not be more than 50% submerged, both for reasons of safety and drag reduction. There was no solution with PVC which kept the weight under 100 lb. and provided sufficient buoyancy.

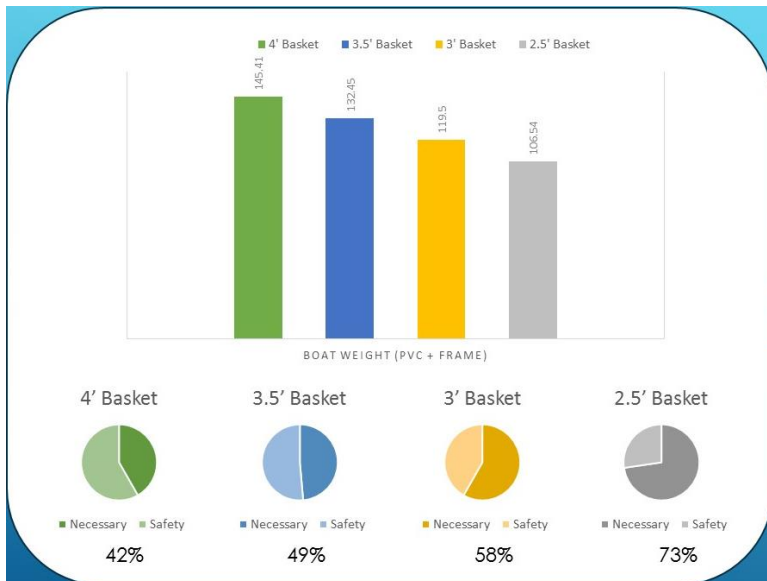

◆ *Battery Life Calculations*

Our battery has a Reserve Capacity of 140. Converted to Amp-hours this is 58.3. Hours of operation can be found from the Amp-hour rating and the average current draw with the following equation:

$$Hours = \frac{AmpHours}{Amps Drawn at Speed}$$

For the current drawn at slow, medium, and high speeds, we used the estimates for a 40-70 lb. thrust motor from TrollingMotors.net. These were 5, 20, and 40 Amps respectively.

◆ *Conveyor Calculations (Checking Belt Strength, Finding Power, Etc.)*

The conveyor calculations were made in TkSolver, based off of the handbook on conveyor design provided to us by our belt supplier, Forbo. (TkSolver Code is included on the next few pages, the Forbo handbook follows.)

Conveyor Calculations

Rules Sheet

Rules

; Shaft diameter check

$$\text{TotalAreaBelt} = \frac{\text{TotalLength} \cdot b_0}{1000}; \text{ have to divide by 1000 to fix units}$$

$m_B = \text{TotalAreaBelt} \cdot \text{BeltDensity}$; Total mass of belt

$$\text{TopAreaBelt} = \frac{b_0 \cdot L_T}{1000}; \text{ divide by 1000 to fix units}$$

$$m = \frac{\text{DensityAzolla} \cdot \text{TopAreaBelt} \cdot \text{AzollaDepth}}{1000}; \text{ divide by 1000 to fix units}$$

$F_V = \mu_T \cdot g \cdot (m + m_B) + g \cdot m \cdot \text{sind}(a)$; effective belt pull

$F_W = F_V \cdot C1 + m_w \cdot g$; shaft load

$$y_w = \frac{80 \cdot F_W \cdot L_{\text{shaft}}^3}{E \cdot d^4 \cdot \pi \cdot 96}; \text{ deflection}$$

$$a_z = \text{atand}\left[\frac{y_w \cdot 2}{L_{\text{shaft}}}\right]$$

; Number of sprockets Calcs

$$F_B = \frac{F_V \cdot C1}{C2}; \text{ Force determining Belt selection}$$

$$C3 = \frac{F_B}{b_0};$$

$$C3_Percentage = \frac{C3}{C3_max} \cdot 100; \text{ x 100 bcs percent}$$

; From the table, for the low C3_percentage, distance between sprockets should be 6.3 in

; Power Reqs for Motor

$$P_A = \frac{F_V \cdot v}{1000 \cdot 60}$$

$$\text{RevMin} = \frac{v}{\text{SprocketD} \cdot \pi}$$

$$\text{RadSec} = \frac{\text{RevMin} \cdot 2 \cdot \pi}{60}$$

$$\text{EstTorque} = \frac{P_A \cdot 1000}{\text{RadSec}}$$

$$\text{GearRatio} = \frac{\text{EstTorque}}{\text{MotorTorque}}$$

$$\text{GearResRPM} = \frac{\text{MotorRPM}}{10}$$

Rules

$$\text{DutyCycle} = \frac{\text{RevMin}}{\text{GearResRPM}}$$

$$\text{EstCurrent} = \frac{P_A \cdot 1000}{\text{DutyCycle} \cdot 12}; \text{ 1000 to fix kW units to W}$$

Variables Sheet

Input	Name	Output	Unit	Comment
.21	μ_T			coefficient of friction w/ wearstrip
9.81	g			gravity [m/s^2]
272	DensityAzolla			Density of Azolla [kg/m^3]
819.15	b_0			Belt width [mm]
.9144	L_T			Center to center length [m]
2.7686	TotalLength			Total length of belt (all around) [m]
5.5	BeltDensity			Belt Density [kg/m^2]
30	a			Angle of conveyor [degrees]
1	C1			Operational factor
1	m_w			mass of drive drum (kg)
1066.8	L_shaft			Bearing center dist of drive shaft [mm]
210000	E			Shaft's modulus of elasticity [N/mm^2]
12.7	d			Drive shaft diameter [mm]
12.7	AzollaDepth			Azolla depth on belt [mm]
1	C2			Temperature Factor
3	C3_max			allowable belt pull max [N/mm]
20	v			Belt speed [m/min]
.098	SprocketD			Sprocket Diameter [m]
.35	MotorTorque			Motor Torque [Nm]
2800	MotorRPM			Motor RPM [rpm]
	TotalAreaBelt	2.267899		Total Belt area (for finding belt mass) [m^2]
	m_B	12.473443		Total mass of belt [kg]
	TopAreaBelt	0.749031		Carrying area of belt [m^2]
	m	2.587452		Azolla load [kg]
	F_V	43.718400		Effective Belt Pull [N]
	F_W	53.528400		Shaft Load [N]
	y_w	3.155499		Deflection [mm]
	a_z	0.338948		engagement angle (borderline is 1.2) [deg]
	F_B	43.718400		Force determining belt selection [N]
	C3	0.053370		[N/mm]
	C3_Percentage	1.779015		
	P_A	0.014573		Calculated power at drive drum [kW]
	RevMin	64.961201		Revolutions per min shaft [rev/min]
	RadSec	6.802721		Radians/sec shaft [rad/sec]
	EstTorque	2.142202		Estimated Torque [Nm]

Input	Name	Output	Unit	Comment
	GearRatio	6.120576		min Gear Ratio to get Torque (shaft larger than motor)
	GearResRPM	280		Shaft RPM under influence of gears only
	DutyCycle	0.232004		Duty cycle needed
	EstCurrent	5.234386		Estimated Current drawn (amps)

siegling prolink

modular belts

Recommendations for constructing and calculating conveyors

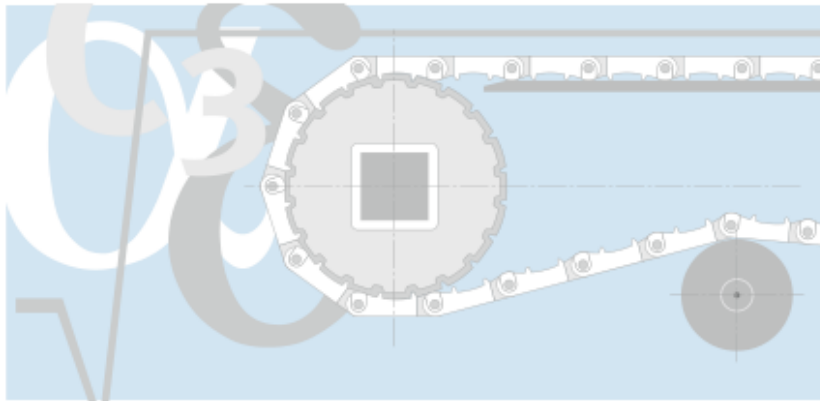

You can obtain detailed information on Siegling Prolink plastic modular belts in the overview of the range (ref. no. 800) and the data sheets on the individual series.

Please note:

When using Prolink Series 11 and the Combo belts (a combination of Prolink Series 5 ST and Prolink Series 11) please refer to: **Series 11/combo belts - Design guidelines and recommendations for use** (ref. no. 201).

Content

Belt support	2
Shafts	3
Conventional conveyors	5
Reversible conveyors	6
Inclined conveyors	7
Nose bar conveyors	9
Recommended minimum radii	10
Curve conveyors	12
Spiral conveyors	14
Further information/ Effect of temperature	15
Calculation	16

Belt support

Skid plate

The belt can be supported in the following ways:

- Continuous plate support made of steel or plastics such as PE 1000. We recommend this for conveyors with heavy loads.
- Straight parallel wearstrips (figs. 1 + 2) made of steel or plastics. This is an inexpensive solution for applications with minimal loads. The belt wear is limited to the areas where the wearstrips support the belt. We recommend a distance of approx. 120 – 150 mm between the wearstrips for the upper side and approx. 200 mm for the return side. Alternatively, snub rollers can be used. Support is always provided in areas which do not have profiles, rollers etc. fitted.
- The belt is supported over the entire width by a V-shaped arrangement of the wearstrips (figs. 3 + 4). This spreads the wear and tear evenly and means heavy loads can be applied.
- Around the curves the belt is supported by plastic guides at the sides, for example PE 1000 or a plastic with lubricating properties, on the inner radius (see fig. 5).

Suitable plastic wearstrips are available from specialized dealers. The width should be approx. 30 – 40 mm, whereby the thickness depends on the height of the screw heads.

The permissible temperature ranges, as given by the manufacturer, must also correspond to the expected operating conditions.

Thermal expansion and contraction must

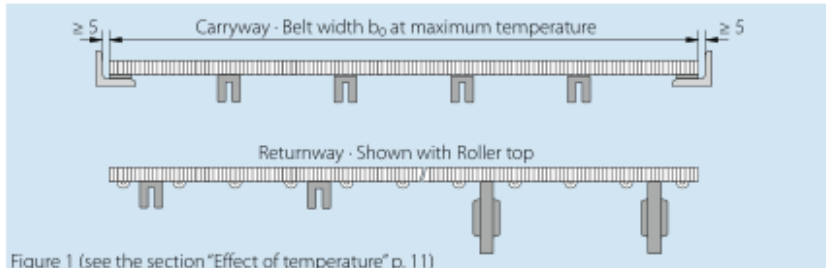

Figure 1 (see the section "Effect of temperature" p. 11)

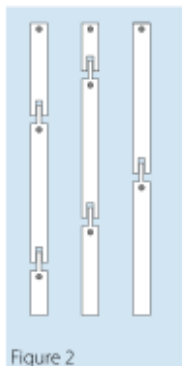

Figure 2

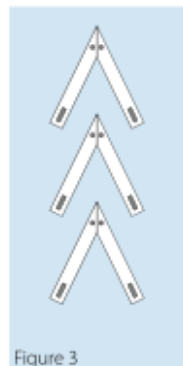

Figure 3

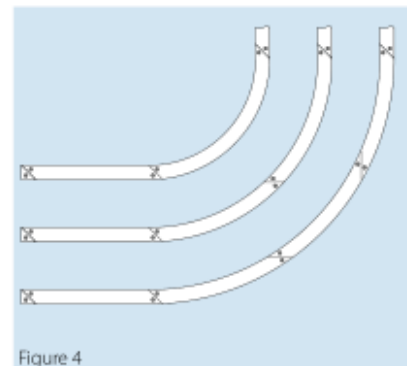

Figure 4

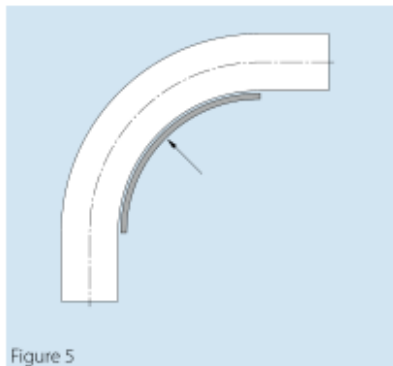

Figure 5

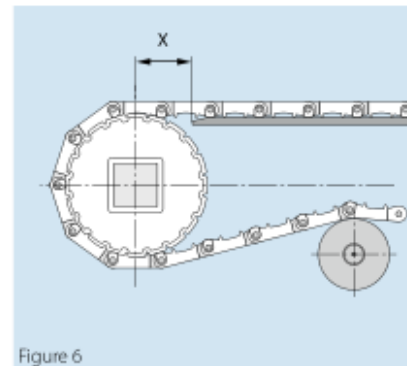

Figure 6

also be taken into consideration when mounting the support. These effects can be eliminated by slots and appropriate distancing between the wearstrips (see the section "Effect of temperature").

- Distance $X \leq 1.5 \times \text{module pitch}$
- Place the snub roller on the return side so that the arc of contact on the drive and idle shafts $\geq 180^\circ$. (This does not apply to conveyors with $e \leq 2 \text{ m}$. Rollers on the return side are not necessary here.)

Roller support

Rollers are not generally used to support the belt on the upper face. Unavoidable belt sag between the rollers as well as the chordal action of the drive unit (see page 11) mean the goods are tipped which can cause problems. Sometimes rollers are used for conveying bulk goods.



Drive Shaft

In general, we recommend the selection of a square shaft. The main advantage of this design is that positive drive and tracking are possible without keys and keyways. This saves on additional manufacturing costs. In addition, this form facilitates the lateral movement of the sprockets in the case of temperature variations.

Occasionally round shafts with feather keys are also used for low-loaded, narrow belts. Specially designed sprockets with bore and keyway are available.

Fastening the sprockets

Usually only 1 sprocket (as near as possible to the centre) must be fastened axially on each idle or drive shaft. The design of this sprocket enables positive tracking of the belt.

Examples of possible methods for fastening a sprocket are shown below:

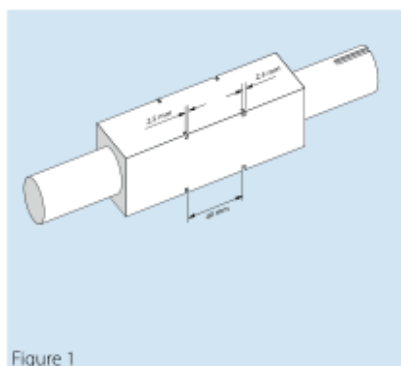

Figure 1

Shaft 40 x 40 mm
Fastening the sprocket with a retainer ring in accordance with DIN 471 (Seeger circlip ring) $d = 56$ mm.

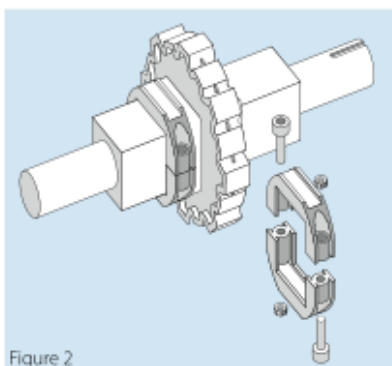

Figure 2

Siegling Prolink Retainer Rings provides a quick, easy and reliable solution for fixing the sprocket (see ref. No 412 for details).

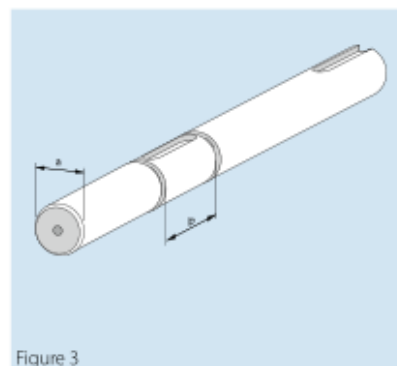

Figure 3

Fixation of the sprocket with retainer rings in accordance with DIN 471 (Seeger circlip ring).

Deflection

Large belt widths and/or high tensile loads can lead to excessive deflection, preventing perfect belt-tooth engagement in the drive area. This results in uneven stress on the teeth of the sprocket, and it is possible that the sprockets do not engage properly, leading to "jumping" of the teeth when the belt is loaded. The borderline value permitted is the tooth engagement angle α_z and depends on the shape of the gear ring and module. For the Siegling Prolink linear belts this is 1.2°.

If the borderline values are exceeded, additional intermediate bearings must be applied or a larger shaft selected.

The tooth engagement angle α_z is calculated using this formula:

$$\alpha_z = \arctan \left(\frac{y_w}{l} \cdot 2 \right)$$

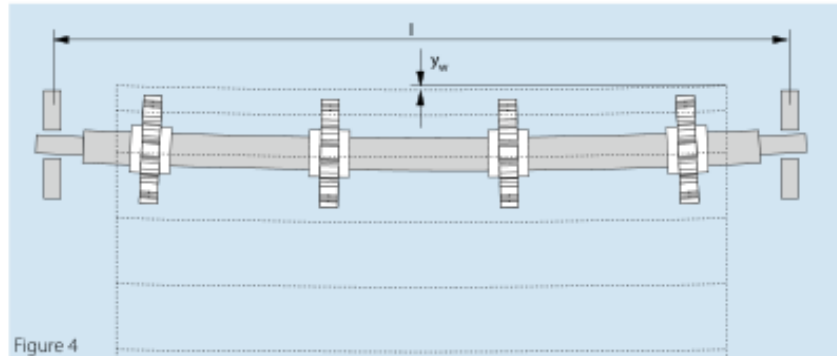

Figure 4

The shaft deflection y_w is calculated using the following formula

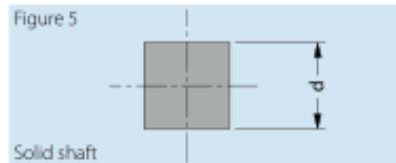

Figure 5

Solid shaft

$$y_w = 0.156 \frac{F_w \cdot l^3}{E \cdot d^4} \quad [\text{mm}]$$

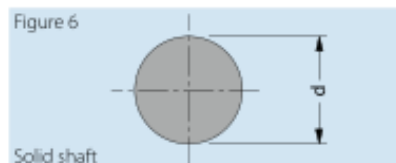

Figure 6

Solid shaft

$$y_w = \frac{80 \cdot F_w \cdot l^3}{E \cdot d^4 \cdot n \cdot 96} \quad [\text{mm}]$$



Figure 7

Hollow shaft

$$y_w = \frac{80 \cdot F_w \cdot l^3}{96 \cdot E \cdot (d_o^4 - d_i^4) \cdot n} \quad [\text{mm}]$$

- F_w = shaft load [N]
- l = bearing centre distance [mm]
- E = shaft's modulus of elasticity [N/mm²] (e.g. for steel = $2.1 \cdot 10^5$ N/mm²)
- d = length of side of square shaft [mm]
- d, d_o, d_i = diameter of shaft [mm]
- y_w = shaft deflection

Conventional conveyors

Belt sag/control of belt length

There are various causes for changes in the belt length, e.g.

- Elongation or contraction of the belt due to temperature variation
- Wear of the connecting rods as well as enlargement of the connecting rod holes in the modules after a certain "break-in time" (enlargement of holes, 0.5-mm larger holes in a 50 mm module result in an elongation of 1%).

Therefore we recommend not supporting one (or several) sections on the return side and using the resulting belt sag to compensate for the increase in length. It is important that perfect engagement between belt and sprocket is ensured. Following are several examples:

- Short conveyor (fig. 1)
- Medium length conveyors, up to a centre distance of approx. 4,000 mm (fig. 2)
- Long conveyors: centre distance > 20,000 mm and low speeds centre distance < 15,000 mm and high speeds (fig. 3)

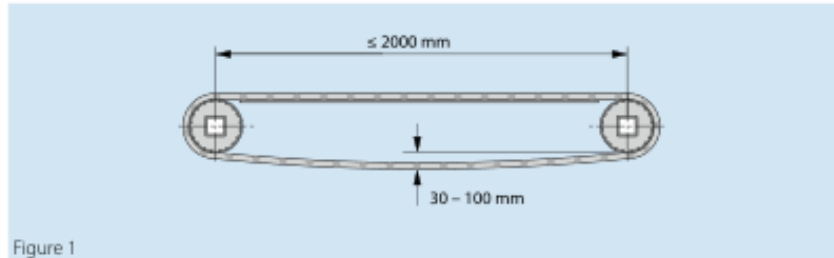

Figure 1

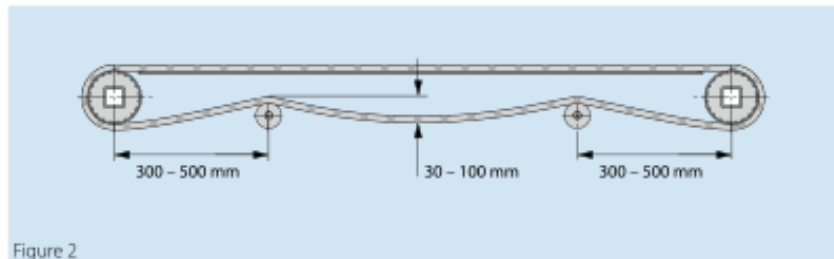

Figure 2

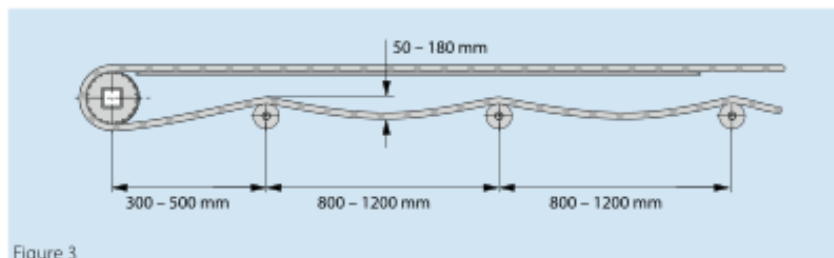

Figure 3

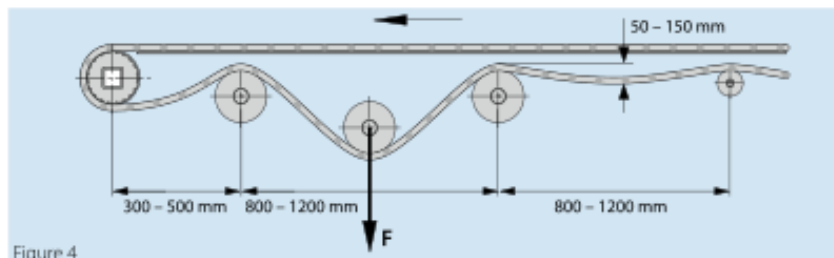

Figure 4

Another effective method for compensating for belt elongation is a load-dependent take-up system (e.g. weighted roller). This should be located as closely to the drive shaft as possible since the take-up system will ensure even tension on the return side and therefore perfect engagement between sprocket and belt (fig. 4).

For series 1, 3 and 7 we recommend a weighted roller, 150 mm in diameter and a weight of approx. 30 kg/m belt width.

For series 2 and 4.1 we recommend a weighted roller, 100 mm in diameter and a weight of approx. 15 kg/m belt width.

For series 6.1 we recommend a weighted roller, 100 mm in diameter and a weight of approx. 60 kg/m belt width.

For series 8 and 10 we recommend a weighted roller, 100 mm in diameter and a weight of approx. 30 kg/m belt width.

For series 13 we recommend a weighted roller, 50 mm in diameter and a weight of approx. 10 kg/m belt width.

Reversible conveyors

Two-motor design

Advantages: Low tension on the return side, making smaller shaft loads possible

Disadvantage: Increased costs due to additional motor and electronic control. For larger conveyors with relatively heavy loads, however, this system may still be the most reasonably priced.

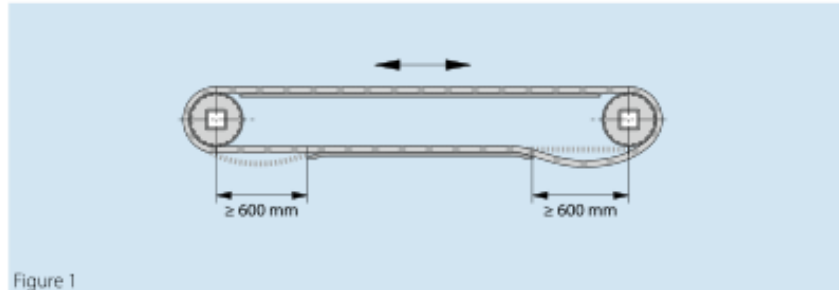

Figure 1

Centre drive

For reversing operation the drive shaft must be located as close to the middle as possible. To the right and the left of the drive unit, areas with belt sag are to be provided, since these are necessary for the required belt tension. The 180° arc of contact on the drive shaft means belt and sprocket engage perfectly making reliable power transmission in both operational directions possible.

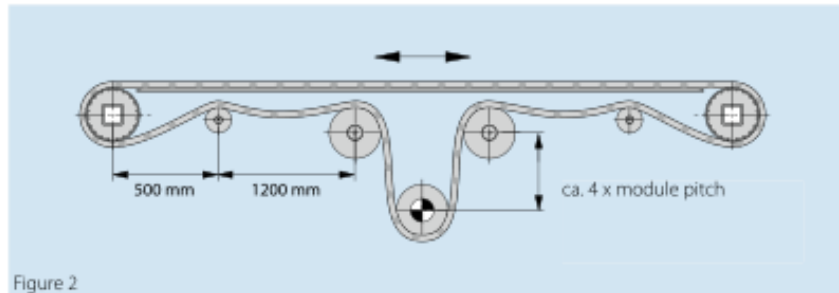

Figure 2

The location of the drive unit causes more stress on the shafts at the ends of the conveyor as there is effective pull on both the upper and return sides in the form of belt tension.

Alternating tail-head drive configuration

In the case of head drives the conveyor is like a conventional conveyor. It is only when conveying direction is reversed that the conveyor become tail-driven and the drive unit has to push the belt and its load. If the tension on the return side is not greater than that on the upper side it will jump sprockets.

An approximate value for the tension on the return side is $1.2 - 1.3 \times F_U$. This automatically leads to a greater shaft load.

$$F_W \approx 2.2 - 2.3 \times F_U$$

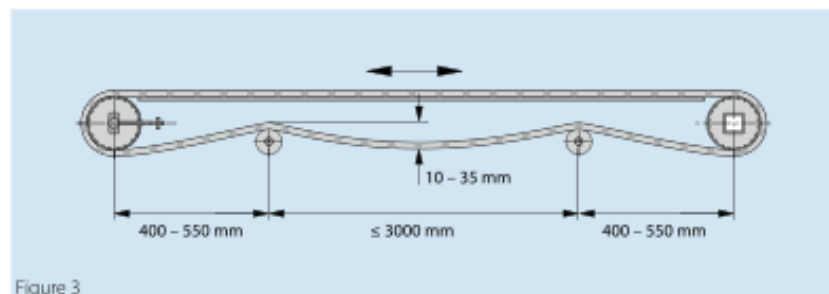

Figure 3

Inclined conveyors

Inclined conveying

We always recommend the following:

- Only operate with a head drive, i.e. use the upper shaft as the drive shaft.
- There is always a screw-operated take-up system or a load-dependent tension take-up on the return side since tension decreases with increasing inclination (caused by the belt sag).
- If sprockets are used at upper intermediate points, the centre sprockets may not be fastened axially.
- If rollers are used at upper intermediate points, a minimum radius of approx. 80 mm is required.
- When shoe or wearstrips are used, the radius should be as large as possible in order to keep wear to a minimum. See page 11 for recommended minimum radius. The width of the shoe should not be smaller than 30 mm.
- If the belt is more than 600 mm wide, we recommend providing further supports on the belt surface or on the profiles on the return side.

Rough guideline on achievable inclines:

- Flat top surface (FLT) 3–5°
- Friction top surface (FRT) 20–40°
- Straight profiles < 60°
- Bent profiles < 90°

Testing is always recommended to determine the actual possible incline angle for a particular product/application.

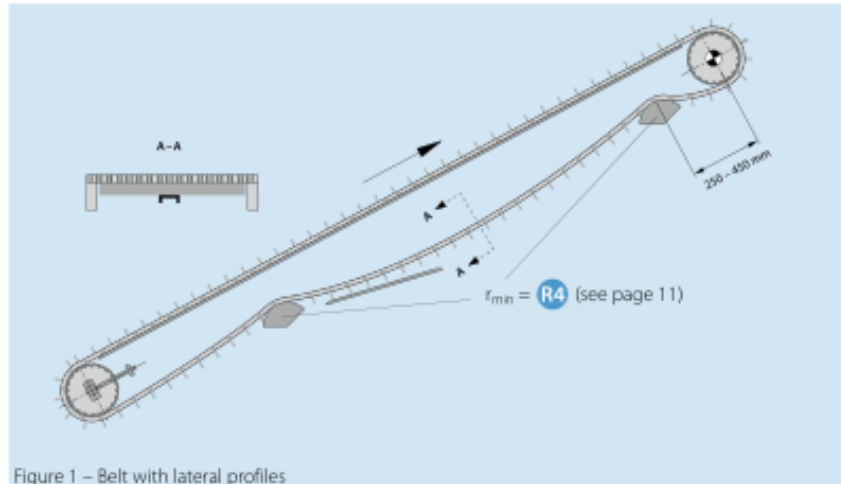

Figure 1 – Belt with lateral profiles

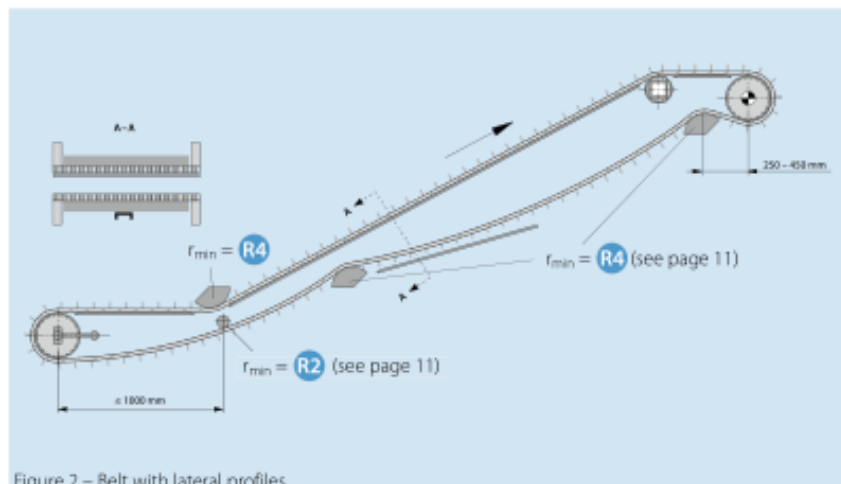

Figure 2 – Belt with lateral profiles

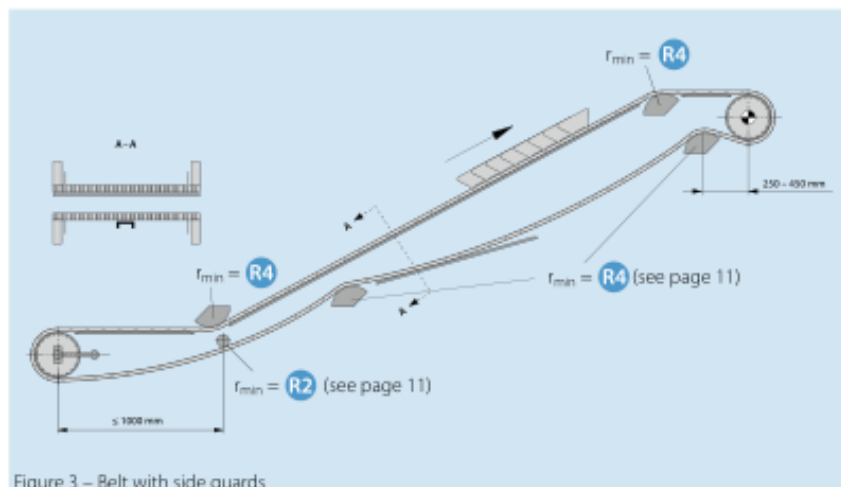

Figure 3 – Belt with side guards

Declined conveying

For this conveyor design, a tail drive unit is possible if there is an active load-dependent tension take-up at the lower idle shaft (e.g. gravity, spring or pneumatic). Otherwise the general recommendations given above apply here.

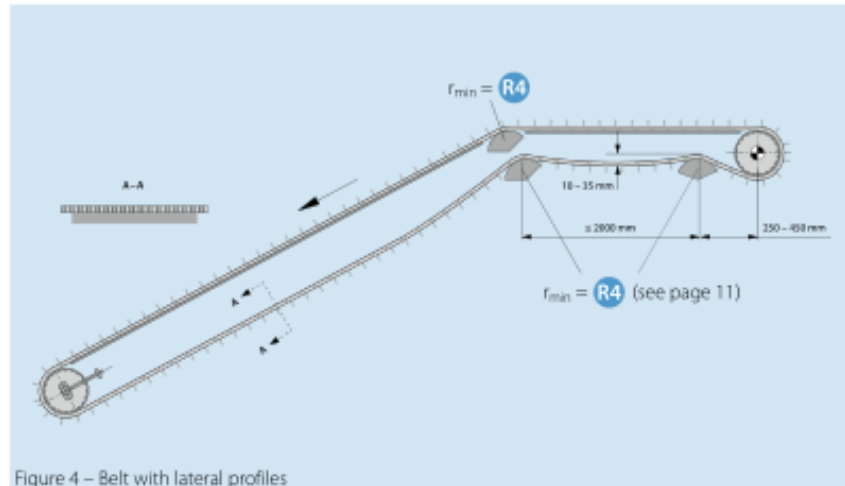

Figure 4 – Belt with lateral profiles

Nose bar conveyors

Tight transfer

Narrow transfer gap ensures smooth transfer of small and delicate products. The radius of the nose bar must be suitable for the selected belt type. For the recommend radius see below.

For optimum product stability (smooth belt run) we recommend:

- a belt wrap angle of 65° to 70°
- a straight support section of minimum $2 \times$ belt pitch before and after the nose bar.

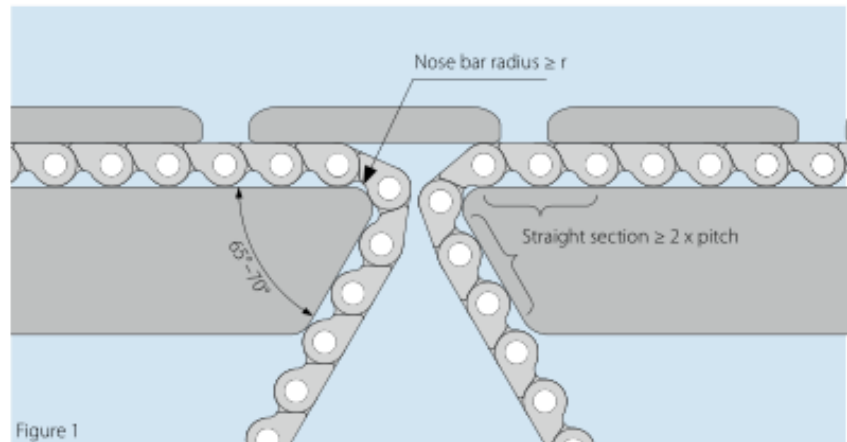
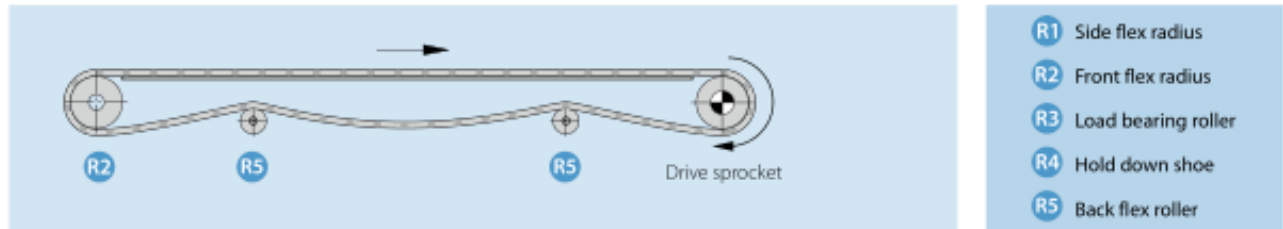

Figure 1

Belt series	Nose bar, r_{\min} [mm]
S13	3
S4.1	11
S2, S5, S8, S10 & S11	25

Recommended minimum radii

Standard conveyors



Centre drive conveyors

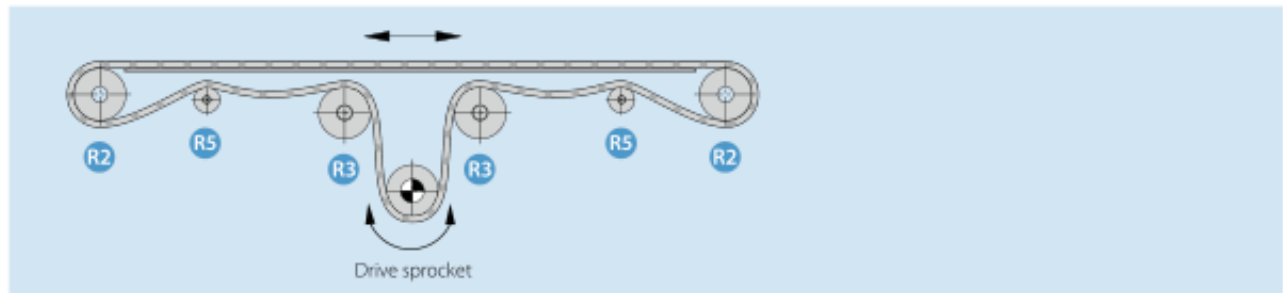
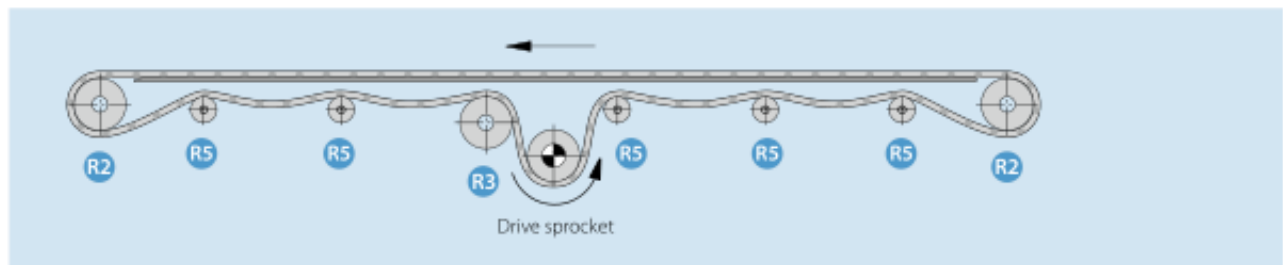

Inclined conveyors

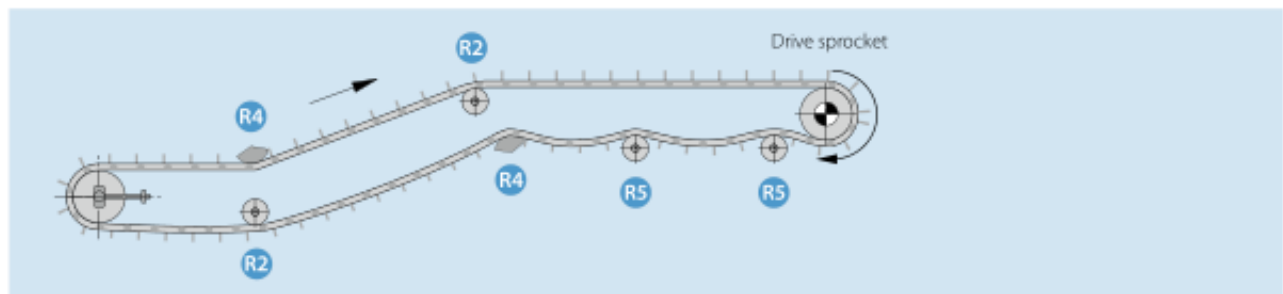

Nose bar conveyors

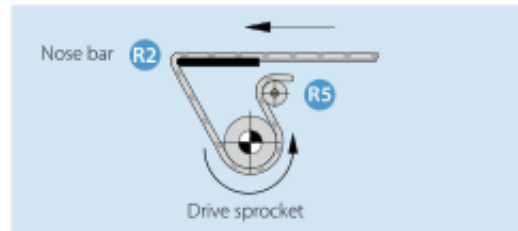

Curved conveyors

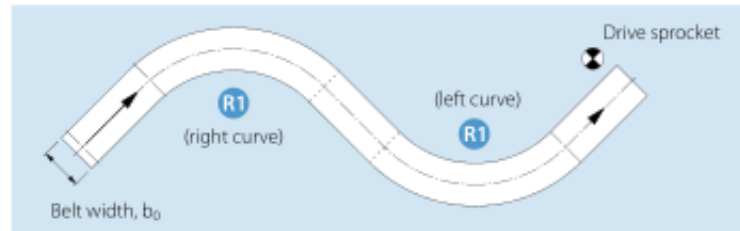

Belt types	Pitch [mm]	Side flex	Front flex	Back flex			
		Min. inner radius [mm] R1	Min. radius on rollers* [mm] R2	Min. radius on load bearing rollers [mm] R3	Min. radius on hold-down shoes [mm] R4	Min. radius on rollers [mm] R5	
S1-x FLT / NSK / FRT / SRS	50		50	100	150	50	
S1-PMU with SG **							150
S2-x FLT / GRT	25		25	50	75	25	
S2-57 RRB							50
S2-x PMU with SG **						50	
S3-x FLT / LRB	50		50	100	150	50	
S3-x with SG **							150
S4.1-x FLT / NPY / NTP	14		11	25	38	12.5	
S4.1-0 FRT1							16.5
S5-45 GRT / NTP / FRT R	25	2 x b ₀	25	50	75	25	
S5-45 PMU with SG **							75
S5-45 G / RG							25
S6.1-x FLT / CTP / NPT / PRR	50		50	100	150	50	
S6.1-x PMU with SG **							150
S7-x FLT / NSK / FRT / SRS / PRR	40		40	80	120	40	
S8-x FLT / NSK / RAT / FRT / SRS / PRR							25
S8-0 RTP A90	25		25	50	75	30	
S8-0 PMU with SG **						75	
S9-57 GRT / NTP	50	1.8 x b ₀	50	100	150	50	
S9-57 PMU with SG **							150
S10-x FLT / NTP / LRB	25		25	50	75	25	
S10-0 PMU with SG **							75
S11-45 GRT / NTP / FRT	25	1.4 x b ₀	25	50	150	25	
S11/SS combo							75
S13-0 FLT / NPY	8	1.45 x b ₀	3***	16	24	8	

Using larger radii than listed will reduce wear on belt, rollers and/or hold-down shoes. Larger radii will also usually reduce noise levels and make the belt run more smoothly.

- * Depending on the application smaller radii are possible (e.g. knife edges).
Speed, possible band noise/jiggle and type of conveyed goods must be considered in these cases.
- ** Back flex radius depends on profile height and distance
- *** Knife edge/nose bar

Curve conveyors

Meshing

The teeth must mesh into the modular belting in the areas marked by the arrows. (fig. 1)

Attention!

In the case of Prolink series 11 and Combo belts (a combination of Prolink series 5 ST and Prolink series 11) different dimensions and characteristics must be taken into account.

Please refer to: **Series 11/Combo belts - Design guidelines and recommendations for use** (ref. no. 201).

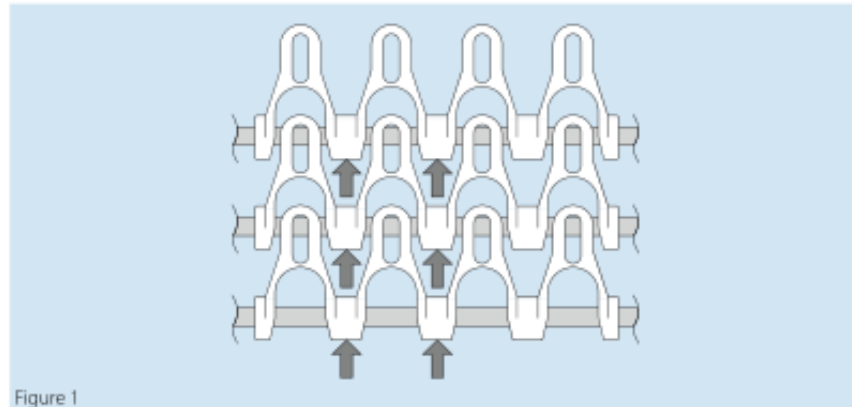

Figure 1

Inner radius

Siegling Prolink inner radius r_{min} for curved belts

Series 5:	$r_{min} = 2 \times b_0$
Series 9:	$r_{min} = 1.8 \times b_0$
Series 11:	$r_{min} = 1.4 \times b_0$
Combo belts	
Series 5 ST/Series 11:	$r_{min} = 1.45 \times b_0$

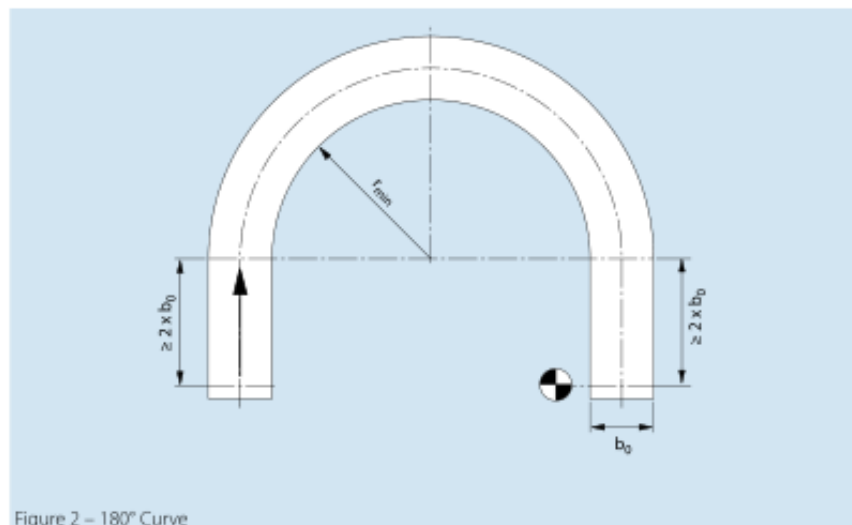

Figure 2 – 180° Curve

Belt tension

The three usual tensioning methods are possible to create the correct belt tension:

- Screw-operated take-up system
- Gravity take-up system
- Catenary sag on the return side near the drive drum

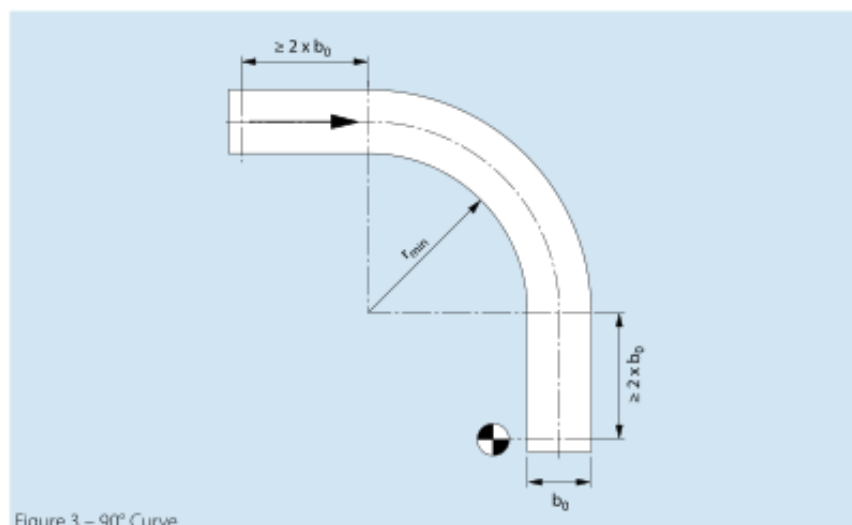

Figure 3 – 90° Curve

Geometries of curves

Please consult us if you cannot construct the conveyor according to the drawings because space is restricted.

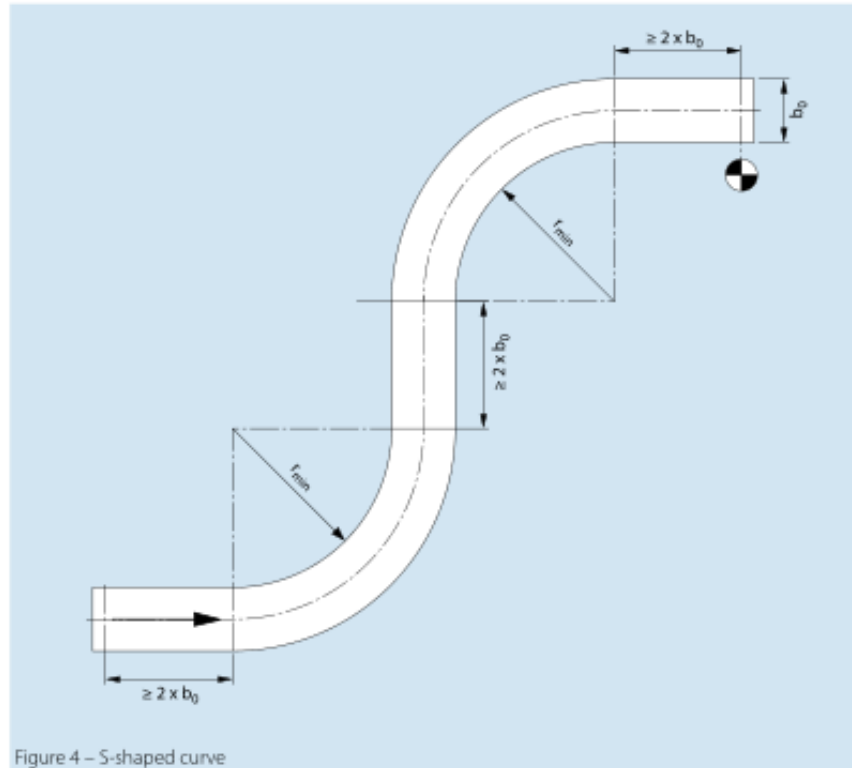

Figure 4 – S-shaped curve

Spiral conveyors

Possible conveyor designs

Fig. 1:

Example of declined conveying to join two production units with different heights.

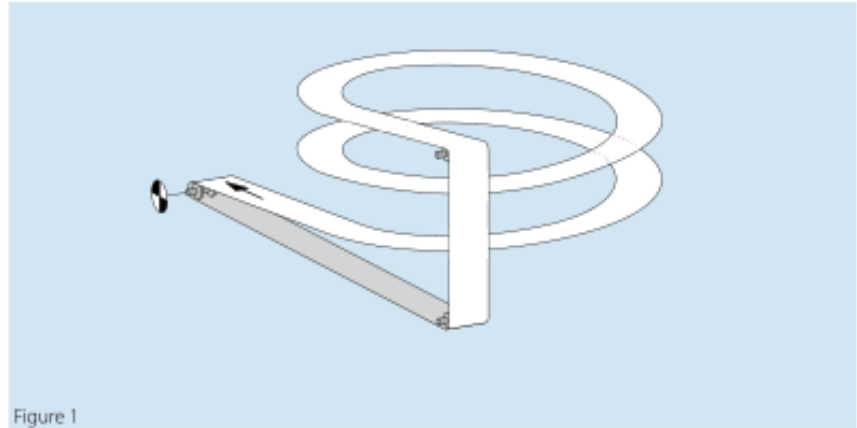

Figure 1

Fig. 2:

For inclined conveying, the drive unit must be located at the end of the curve at the top. Make sure that the arc of contact on the drive shaft is approx. 180°. This type of design (without driven inner cage) should not have more than 2 – 3 tiers.

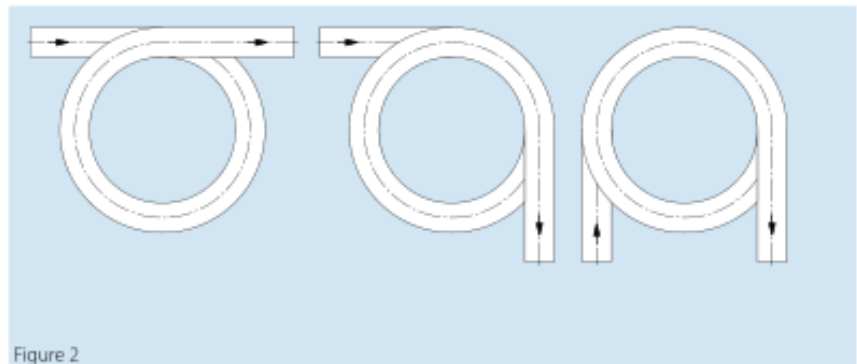

Figure 2

Fig. 3:

The main drive system is the driven inner cage, which as a rule consists of vertical rods. The curved belt is supported on the inner radius by the cage and is moved by traction between the belt and the cage. The direction of rotation of the cage determines whether the conveying is inclined or declined.

The drive and tensioning unit depicted in the sketch provides the necessary belt tension. The speed of the motor must be coordinated with the speed of the cage drive.

It should be possible to move the tensioning unit a distance corresponding to approx. 1% of the belt length. The belt can be supported by wearstrips as described on page 2.

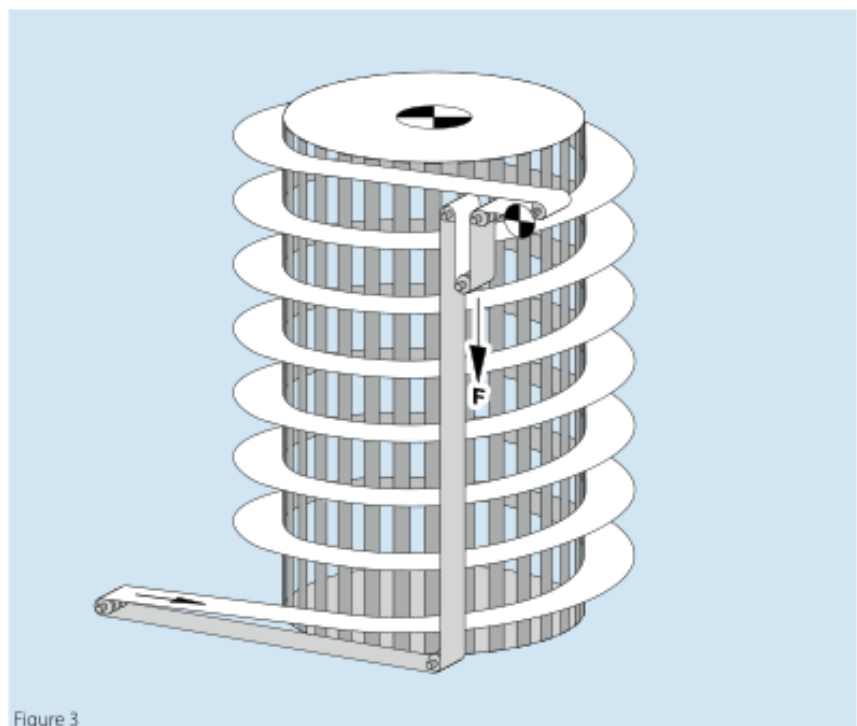

Figure 3

Further information

Effect of temperature

Plastics can expand or contract significantly when temperatures fluctuate. The construction engineer must make allowances for changes in belt lengths and widths if the operating temperature is not the same as the ambient temperature. Essentially, this affects the belt sag on the return side and the lateral clearance on the conveyor frame.

Material	Coefficient of thermal expansion a [mm/m/°C] *
PA	0.12
PA-HT	0.10
PBT	0.16
PE	0.21
POM	0.12
POM-CR	0.12
POM-HC	0.12
POM-MD	0.12
PP	0.15
PXX	0.15
PXX-HC	0.15

* Average values for the permissible temperature range

Calculation of changes in length and width:

$$\Delta l = l_0 \cdot (t_2 - t_1) \cdot a$$

$$\Delta b = b_0 \cdot (t_2 - t_1) \cdot a$$

Calculation example:
Ambient temperature 20°C, the belt is used for the conveying of hot goods, resulting in an operating temperature of 90°C. Belt length 30 m, belt width 1 m, belt material polypropylene.

$$\Delta l = 30 \cdot (90 - 20) \cdot 0.15$$

$$\Delta l = 315 \text{ mm}$$

$$\Delta b = 1 \cdot (90 - 20) \cdot 0.15$$

$$\Delta b = 10.5 \text{ mm}$$

The increase in belt length of 315 mm is not insignificant which means that the return side must be designed in such a way that the additional belt sag is absorbed. In order to accommodate the increase in width, the conveyor frame must have a wider design.

When operating at temperatures below 0°C, the length and width contract. This must also be accommodated in the conveyor design.

Δl = change in length in mm
+ = elongation
- = contraction

l_0 = belt length at initial temperature in m

b_0 = belt width at initial temperature in m

t_2 = operating temperature °C

t_1 = initial temperature °C

a = coefficient of thermal expansion mm/m/°C

Chordal action

What is known as chordal action is typical for all sprocket-driven belts, chains etc. The rise and fall of a module during the slewing motion cause changes in the linear speed of the belt. The number of teeth on sprocket is the decisive factor for these periodic fluctuations in speed.

As the number of teeth increases, the percentual change in speed decreases. In practice this means that the largest number of teeth possible must be used if the goods are not to tip or for other reasons an even belt speed is required.

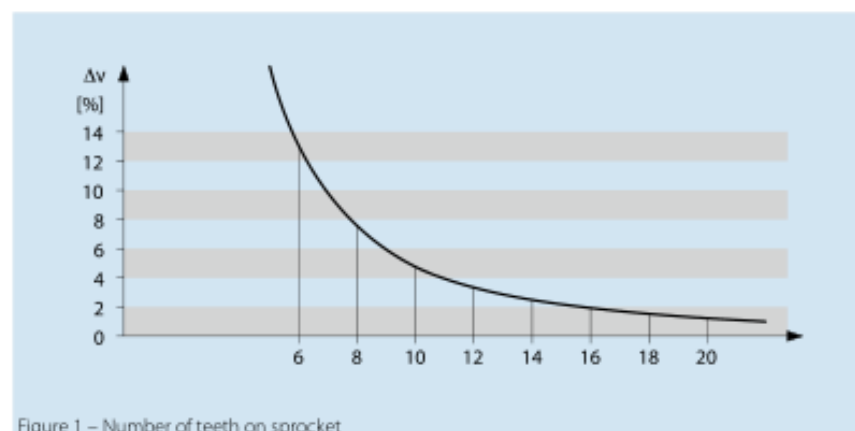

Figure 1 – Number of teeth on sprocket

Calculation

Key to the symbols

Designation	Symbols	Unit
Effective belt pull	F_U	N
Force determining belt selection	F_B	N
Shaft load	F_W	N
Calculated power at drive drum	P_A	kW
Coefficient of friction with accumulated goods	μ_{ST}	-
Coefficient of friction with skid plate	μ_T	-
Operational factor	C_1	-
Temperature factor	C_2	-
Adjusted belt pull	C_3	N/mm (lb/ft)
Allowable belt pull	$C_3 \text{ max}$	N/mm (lb/ft)
Acceleration due to gravity	g	9.81 m/s ²
Conveyor length	l_T	m
Height of lift	h_T	m
Mass of entire belt (see data sheet)	m_B	kg
Total load	m	kg
Mass of drive drum	m_W	kg
Angle of conveyor	α	°
Belt width	b_0	mm
Belt speed	v	m/min

Loading examples to determine the effective pull F_U

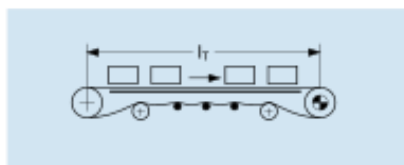

$$F_U = \mu_T \cdot g \cdot (m + m_B)$$

[N]

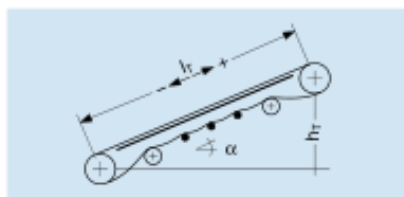

$$F_U = \mu_T \cdot g \cdot (m + m_B) + g \cdot m \cdot \sin \alpha$$

[N]

(+) inclined
(-) declined

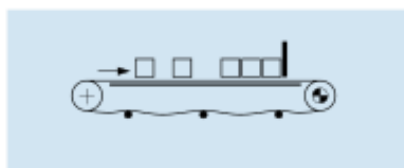

$$F_U = \mu_T \cdot g \cdot (m + m_B) + \mu_{ST} \cdot g \cdot m$$

Mass of rotating parts on the return side was ignored.

[N]

A

One of the three following formulae is used to calculate F_U , depending on the design of the conveyor.



Coefficients of friction μ_T between belt and wearstrip

The figures stated have been established under ideal conditions. When operating under other conditions we recommend using higher friction coefficients. (*- = not recommended combinations)

Wearstrip material	Belt material	PE & PE-MD			PP, PXX PXX-HC			POM incl. CR, HC & MD			PA-HT		
	Operating conditions	clean	regular	soiled	clean	regular	soiled	clean	regular	soiled	clean	regular	soiled
Hardwood	dry	0.16	0.16	0.24	0.22	0.39	0.59	0.16	0.22	0.32	0.18	0.19	0.29
	wet	-	-	-	-	-	-	-	-	-	-	-	-
HDPE	dry	-	-	-	0.14	0.19	0.29	0.08	0.19	0.29	0.15	0.23	0.34
	wet	-	-	-	0.12	0.17	0.26	0.08	0.12	0.25	-	-	-
Lubric. PA	dry	0.18	0.28	0.45	0.13	0.24	0.35	0.12	0.20	0.30	0.16	0.24	0.36
	wet	-	-	-	-	-	-	-	-	-	-	-	-
Steel	dry	0.14	0.23	0.38	0.25	0.31	0.47	0.18	0.23	0.35	0.20	0.31	0.45
	wet	0.13	0.21	0.33	0.24	0.29	0.44	0.14	0.17	0.26	-	-	-
UHMW PE	dry	0.30	0.31	0.47	0.13	0.22	0.35	0.13	0.17	0.32	0.18	0.24	0.38
	wet	0.27	0.28	0.45	0.11	0.20	0.32	0.11	0.15	0.28	-	-	-

Coefficients of friction μ_{ST} between belt and conveyed product (*- = not recommended combinations)

Conveyed product	Belt material	PE & PE-MD			PP, PXX & PXX-HC			POM incl. CR, HC & MD			PA-HT		
	Operating conditions	clean	regular	soiled	clean	regular	soiled	clean	regular	soiled	clean	regular	soiled
Cardboard	dry	0.15	0.19	0.34	0.22	0.31	0.55	0.20	0.30	0.50	0.20	0.30	0.50
	wet	-	-	-	-	-	-	-	-	-	-	-	-
Glass	dry	0.10	0.15	0.25	0.16	0.24	0.41	0.13	0.20	0.35	0.13	0.20	0.33
	wet	0.09	0.13	0.22	0.17	0.21	0.37	0.13	0.18	0.33	-	-	-
Metal	dry	0.13	0.20	0.33	0.32	0.48	0.60	0.17	0.27	0.45	0.20	0.30	0.50
	wet	0.11	0.17	0.28	0.29	0.45	0.58	0.16	0.25	0.42	-	-	-
Plastic	dry	0.10	0.13	0.25	0.15	0.21	0.37	0.15	0.25	0.41	0.13	0.20	0.33
	wet	0.08	0.11	0.22	0.14	0.19	0.34	0.14	0.21	0.36	-	-	-

Force determining belt selection F_B

B

$$F_B = F_U \cdot \frac{C_1}{C_2}$$

[N]

Operational factor C_1

	C_1
Smooth operating conditions (smooth start)	+ 1.0
Start-Stop-operation (start when loaded)	+ 0.2
Tail drive (push configuration)	+ 0.2
Belt speed greater than 30 m/min	+ 0.2
Inclined or swan-neck conveyor	+ 0.4
	Total C_1 -----

Temperature factor C_2

The tensile strength of the different materials increases at temperatures below 20°C but at the same time other mechanical properties are reduced at low temperatures. Therefore the C_2 factor is set to 1.0 at temperatures below 20°C.

The temperatures relate to the actual belt temperature. Depending on the application and conveyor layout the temperature of the conveyed product may be different.

Temperature [°C]	Belt material				
	PE	PP	POM	PA	PA HT
-60	1.0	-	-	-	-
-40	1.0	-	1.0	-	-
-20	1.0	-	1.0	1.0	1.0
0	1.0	-*	1.0	1.0	1.0
+20	1.0	1.0	1.0	1.0	1.0
+40	0.90	1.0	1.0	1.0	1.0
+60	0.62	0.85	0.96	0.95	1.0
+80	-	0.65	0.75	0.72	1.0
+100	-	0.45	-	0.50	1.0
+120	-	-	-	0.40	1.0
+140	-	-	-	-	1.0
+155	-	-	-	-	1.0

* below + 7 °C avoid impact and ensure smooth start

Counter-checking the Siegling Prolink type selection

C

$$\frac{F_3}{b_3} = C_3 \leq C_3 \text{ max}$$

Allowable belt pull $C_3 \text{ max}$

Type	Material	PE [N/mm (lb/ft)]	PP [N/mm (lb/ft)]	POM [N/mm (lb/ft)]	PA [N/mm (lb/ft)]
S1		18 (1233)	30 (2055)	40 (2740)	-
S2		3 (206)	5 (343)	7 (480)	-
S3		6 (411)	12 (822)	16 (1096)	-
S4.1		3 (206)	5 (343)	10 (685)	-
S5 straight		10 (685)	18 (1233)	25 (1713)	-
S5 curved		-	1000 N/225 lb	1800 N/405 lb	-
S5 ST straight		10 (685)	18 (1233)	25 (1713)	-
S5 ST curved		-	1200 N/270 lb	2100 N/473 lb	-
S6.1		13 (891)	18 (1233)	30 (2055)	30 (2055)
S7		18 (1233)	30 (2055)	50 (3425)/60 (4110)*	-
S8		15 (1028)	20 (1370)	40 (2740)	-
S9 straight		12 (822)	22 (1507)	30 (2055)	24 (1644)
S9 curved		-	1600 N/360 lb	2800 N/630 lb	2240 N/504 lb
S10		6 (411)/3 (206)*	8 (548)/5 (343)*	20 (1370)/11 (754)*	20 (1370)/11 (754)*
S11 straight		-	9 (887)	15 (1028)	15 (1028)
S11 curved		-	600/135 lb	1000/225 lb	1000/225 lb
S13		-	-	4 (274)	-

* depending on belt configuration

Number of sprockets on the drive drum (guidelines)

Where centre distances are substantial, the number of drive sprockets still depends on the engagement ratio between teeth/module (i.e. on the belt length).

$C_3 \leq 20 \%$ from $C_3 \text{ max}$, the distance between the sprockets should then be approx. 160 mm (6.3 in).

$C_3 \leq 40 \%$ from $C_3 \text{ max}$, the distance between the sprockets should then be approx. 100 mm (3.9 in).

$C_3 \leq 60 \%$ from $C_3 \text{ max}$, the distance between the sprockets should then be approx. 80 mm (3.1 in).

$C_3 \leq 80 \%$ from $C_3 \text{ max}$, the distance between the sprockets should then be approx. 60 mm (2.4 in).

$C_3 > 80 \%$ from $C_3 \text{ max}$, please inquire.

Shaft load F_W

D

$$F_W \approx F_U \cdot C_1 + m_w \cdot g \quad [\text{N}]$$

Power requirement at the drive drum P_A

E

$$P_A = \frac{F_U \cdot v}{1000 \cdot 60} \quad v \text{ in m/min} \quad [\text{kW}]$$



Because our products are used in so many applications and because of the individual factors involved, our operating instructions, details and information on the suitability and use of the products are only general guidelines and do not absolve the ordering party from carrying out checks and tests themselves. When we provide technical support on the application, the ordering party bears the risk of the machinery functioning properly.

Forbo Siegling service – anytime, anywhere

The Forbo Siegling Group employs more than 2,000 people. Our products are manufactured in nine production facilities across the world. You can find companies and agencies with warehouses and workshops in over 80 countries. Forbo Siegling service points are located in more than 300 places worldwide.

► APPENDIX C – POND CHARACTERIZATION TESTING DATA

◆ *Physical Information*

We found the surface area of the ponds using satellite images, and checked the results by comparing the image perimeters with GPS measurements. We then measured pond depth at multiple locations, and found pond volume by multiplying average depth with surface area. (We found that the ponds were fairly uniform in depth, shallow all the way to the middle.)

Physical Pond Measurements			
	<i>Measurement</i>	<i>Upper Pond</i>	<i>Lower Pond</i>
1	<i>Perimeter</i>	<i>710 ft.</i>	<i>610 ft.</i>
2	<i>Surface Area</i>	<i>24,100 ft²</i>	<i>21,200 ft²</i>
3	<i>Average Depth</i>	<i>2.9 ft.</i>	<i>2.8 ft.</i>
4	<i>Volume</i>	<i>70,670 ft³</i>	<i>58,720 ft³</i>

◆ *Chemical Information*

We took water samples from the pond to Anatek Labs to be tested for dissolved inorganic nitrogen (DIN) and dissolved inorganic phosphorus (DIP). Both were at undetectable levels, so not unusually high for a pond. The results are included on the following pages. (DIN is made up of NH₃-N and NO₃-N. DIP is made of PO₄-P. These are the parameters listed on the test results.)

Anatek Labs, Inc.

1282 Alturas Drive • Moscow, ID 83843 • (208) 883-2839 • Fax (208) 882-9246 • email moscow@anateklabs.com
504 E Sprague Ste. D • Spokane WA 99202 • (509) 838-3999 • Fax (509) 838-4433 • email spokane@anateklabs.com

Client: UNIVERSITY OF IDAHO
Address: 875 PERIMETER DR MS 3022
MOSCOW, ID 83844
Attn: DEV SHRESTHA

Batch #: 161109071
Project Name: UNIVERSITY OF IDAHO

Analytical Results Report

Sample Number	161109071-001	Sampling Date	11/9/2016	Date/Time Received	11/9/2016	12:05 PM		
Client Sample ID	LOWER POND 1	Sampling Time	7:00 AM					
Matrix	Water							
Comments								
Parameter		Result	Units	PQL	Analysis Date	Analyst	Method	Qualifier
NH3-N		ND	mg/L	0.05	11/14/2016	MER	SM4500NH3G	

Sample Number	161109071-002	Sampling Date	11/9/2016	Date/Time Received	11/9/2016	12:05 PM		
Client Sample ID	UPPER POND 1	Sampling Time	7:00 AM					
Matrix	Water							
Comments								
Parameter		Result	Units	PQL	Analysis Date	Analyst	Method	Qualifier
NH3-N		ND	mg/L	0.05	11/14/2016	MER	SM4500NH3G	

Sample Number	161109071-003	Sampling Date	11/9/2016	Date/Time Received	11/9/2016	12:05 PM		
Client Sample ID	LOWER POND 2	Sampling Time	7:00 AM					
Matrix	Water							
Comments								
Parameter		Result	Units	PQL	Analysis Date	Analyst	Method	Qualifier
NO3/N		ND	mg/L	0.1	11/9/2016 9:00:00 PM	MER	EPA 300.0	
PO4/P		ND	mg/L	0.1	11/9/2016 9:00:00 PM	MER	EPA 300.0	

Anatek Labs, Inc.

1282 Alturas Drive • Moscow, ID 83843 • (208) 883-2839 • Fax (208) 882-9246 • email moscow@anateklabs.com
504 E Sprague Ste. D • Spokane WA 99202 • (509) 838-3999 • Fax (509) 838-4433 • email spokane@anateklabs.com

Client: UNIVERSITY OF IDAHO
Address: 875 PERIMETER DR MS 3022
MOSCOW, ID 83844
Attn: DEV SHRESTHA

Batch #: 161109071
Project Name: UNIVERSITY OF IDAHO

Analytical Results Report

Sample Number	161109071-004	Sampling Date	11/9/2016	Date/Time Received	11/9/2016 12:05 PM
Client Sample ID	UPPER POND 2	Sampling Time	7:00 AM		
Matrix	Water				
Comments					

Parameter	Result	Units	PQL	Analysis Date	Analyst	Method	Qualifier
NO3/N	ND	mg/L	0.1	11/9/2016 9:21:00 PM	MER	EPA 300.0	
PO4/P	ND	mg/L	0.1	11/9/2016 9:21:00 PM	MER	EPA 300.0	

Authorized Signature

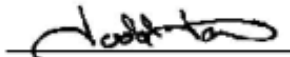

Todd Taruscio, Lab Manager

MCL EPA's Maximum Contaminant Level
ND Not Detected
PQL Practical Quantitation Limit

This report shall not be reproduced except in full, without the written approval of the laboratory.
The results reported relate only to the samples indicated.
Soil/solid results are reported on a dry-weight basis unless otherwise noted.

► **APPENDIX D – MANUALS/DATA SHEETS**

◆ *S10 Belt Brochure*

See following pages for information about the S10 model prolink belt.

Product range

Series 10

Pitch 25.4 mm (1 in)

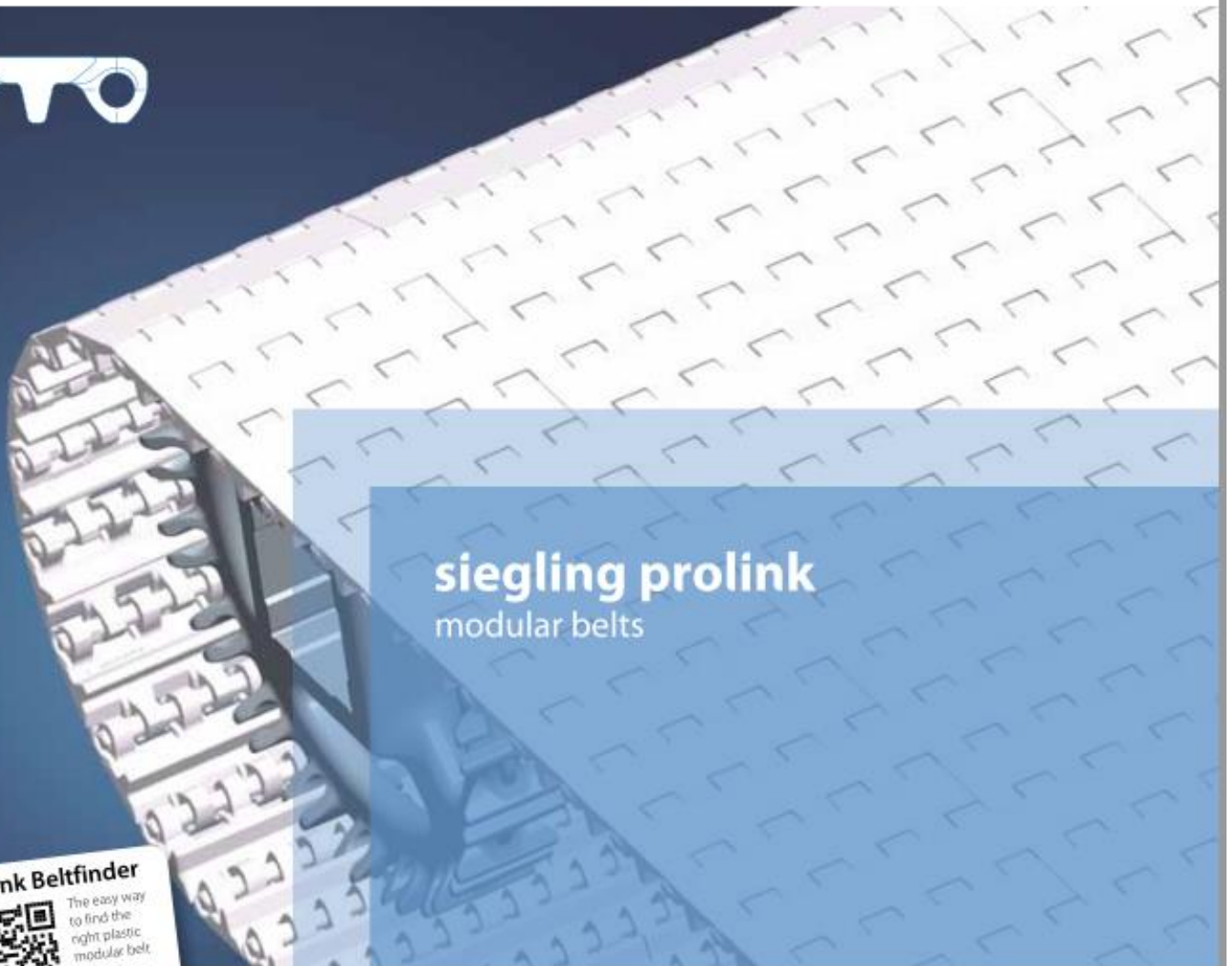

siegling prolink
modular belts

Prolink Beltfinder



The easy way
to find the
right plastic
modular belt
for your
conveyor.

m.prolink-finder.com

Siegling – total belting solutions

forbo

MOVEMENT SYSTEMS

Series 10



Scale 1:1

Straight running,
pitch 25.4 mm (1 in)

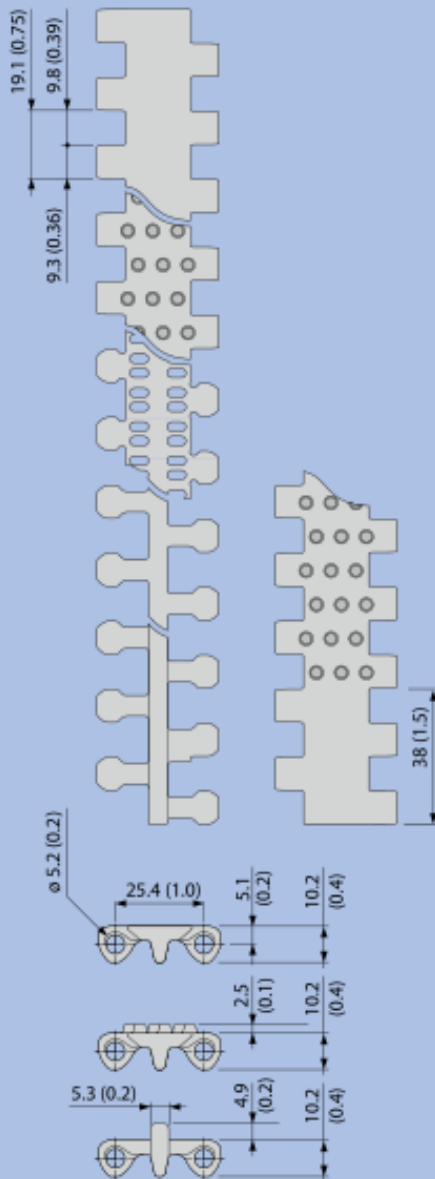

25.4 mm (1 in) pitch straight running belt for light and medium-duty hygiene-critical applications.

Design characteristics

- small number of eyelets ensures easy cleaning
- hinges that open wide, combined with smooth, flat channels on the underside and a continuous drive bar produce an easy-to-clean design
- robust design guarantees superior durability
- optimal design of sprocket teeth and tracking fins provides superior sprocket engagement, safe belt tracking and an easy-to-clean sprocket

Special features

- open area for excellent air circulation and drainage (2 versions for different product sizes)
- nub top surface for excellent release of wet and sticky products
- open area lateral rib version for small inclines and gentle conveying of delicate products
- profiles with no cling surface to improve release of wet and sticky products
- side guards for retention of bulk products
- Hold Down tabs for additional guiding (see info ref. no. 313)

Pitch

25.4 mm (1 in)

Belt width min.

38.1 mm (1.5 in)

Width increments

In increments of 19.05 mm (0.75 in)

Hinge pins

5 mm (0.2 in) made of plastic (PE, PP, PBT)

Key dimensions in mm and inches (in), scale 1:2.
All imperial dimensions (inches) are rounded off.
* Depending on products/applications

Belt types

S10-0 FLT

Closed, smooth surface

S10-0 NTP

Closed surface with round studs
5% contact area
Version available without round studs at the side (38 mm indent)

S10-22 FLT

Open (22%), smooth surface
55% contact area
(Largest opening: 2.6 x 5.3 mm/0.10 x 0.21 in)

S10-36 FLT

Open (36%), smooth surface
26% contact area
(Largest opening: 5.7 x 13.3 mm/0.22 x 0.52 in)

S10-36 LRB

Open (36%) surface and lateral ribbing
5% contact area*
(Largest opening: 5.7 x 13.3 mm/0.22 x 0.52 in)

Declaration of compliances/Certificates

See fold-out page

Drum motor

Power transmission using drum motors with rubber coating and profiles applied is possible. Please enquire.

Materials	Colours	Open area [%]	Allowable belt pull [N/mm (lb/ft ²)]	Weight [kg/m ² (lb/ft ²)]
-----------	---------	---------------	--	--



PE	WT, LB	0	6 (411)	5.4 (1.1)
PE-MD	BL	0	6 (411)	6.2 (1.3)
PP	WT, LB	0	8 (548)	5.1 (1.0)
PP-MD	BL	0	8 (548)	5.6 (1.2)
POM	WT, LB	0	20 (1370)	8.0 (1.6)
POM-MD	BL	0	20 (1370)	8.3 (1.7)

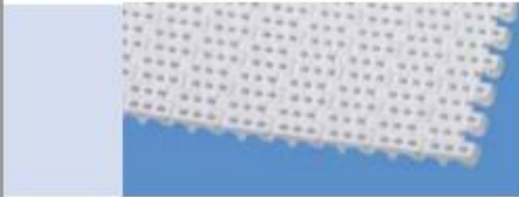

PE	WT	0	6 (411)	5.5 (1.1)
PP	WT	0	8 (548)	5.2 (1.0)
POM	WT, LB	0	20 (1370)	8.2 (1.6)

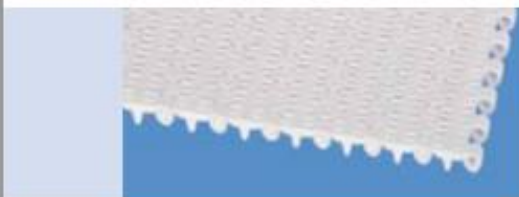

PE	WT, LB	22	3 (206)	4.7 (1.0)
PP	WT, LB	22	5 (343)	4.3 (0.9)
POM	WT, LB	22	11 (754)	6.7 (1.4)



PE	WT, LB	36	4 (274)	4.3 (0.9)
PP	WT, LB	36	6 (411)	4.0 (0.8)
PP-MD	BL	36	6 (411)	4.4 (0.9)
POM	WT, LB	36	13 (891)	6.2 (1.3)
PA	BL	36	13 (891)	6.0 (1.2)

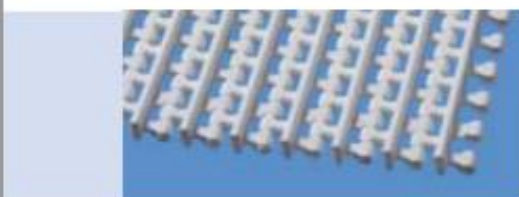

PE	WT, LB	36	4 (274)	5.8 (1.2)
PP	WT, LB	36	6 (411)	4.9 (1.0)
POM	WT, LB	36	13 (891)	7.6 (1.6)

Sprockets

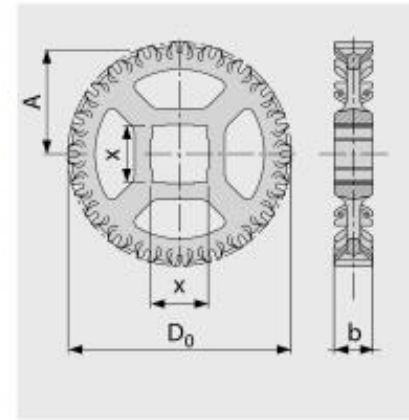

Sprocket size	Z6	Z10	Z12	Z16	Z20
b [mm]	28	28	28	28	28
[in]	(1.1)	(1.1)	(1.1)	(1.1)	(1.1)
D ₀ [mm]	51	82	98	130	162
[in]	(2.0)	(3.2)	(3.9)	(5.1)	(6.4)
A [mm]	20	36	44	60	76
[in]	(0.8)	(1.4)	(1.7)	(2.4)	(3.0)

x [mm] (sprocket bore metric)	Z6	Z10	Z12	Z16	Z20
25	●				
30		●			
40		■	■	■	■

x [in] (sprocket bore imperial)	Z6	Z10	Z12	Z16	Z20
1	●	●			
1.5		■	■	■	■

- Sprocket bore round
- Sprocket bore square

- b Sprocket width
- D₀ Pitch circle diameter
- A Distance centre of sprocket bore/top edge support

The abbreviations and type key are explained on the fold-out page at the back.

Profile and side guard designs

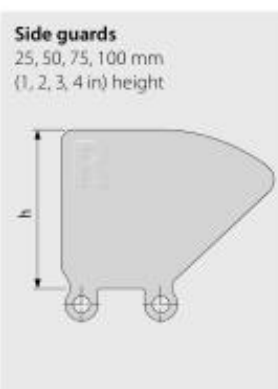
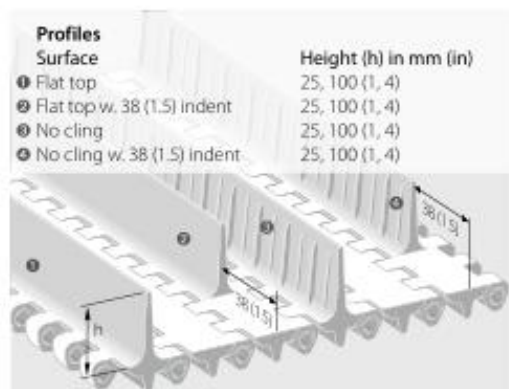

Temperature ranges in °C

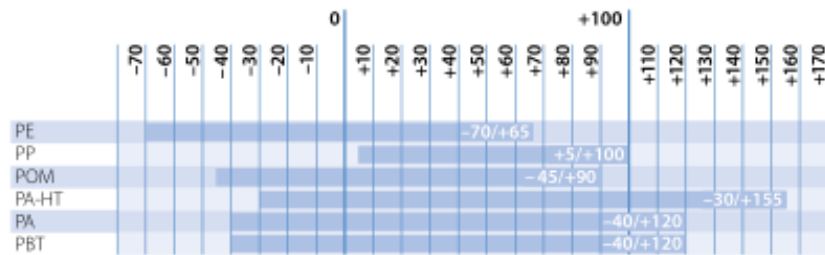

Temperature ranges in °F

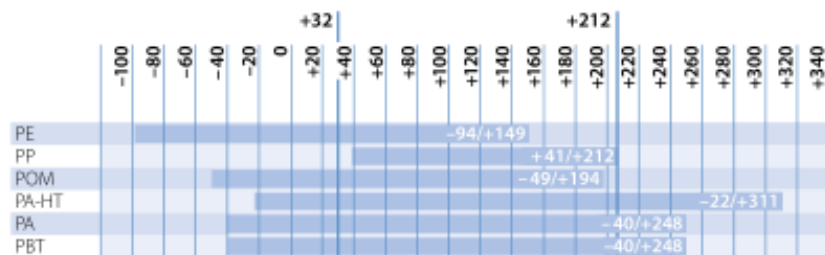

HACCP types

Series 4.1, 6.1, 10 and 13 in particular support your HACCP concept with a number of hygiene-friendly characteristics. These features include:

Easy-to-clean design

- with wide channels underneath the module

Excellent resistance to hydrolysis

- resistant to hot water, cleaning agents and disinfectants

Good release properties

- beneficial when manufacturing adhesive foodstuffs (minimal product wastage)
- product residue is easy to remove
- easy-to-clean hinge design

Blue a strong colour contrast

- soiling is easier to identify
- suitable for usage in optical sorters
- reduces light reflection, making working conditions better

Declaration of compliances/ Certificates

FDA/EU

Siegling Prolink modular belts made of PE, PP, POM and PA comply with FDA 21 CFR as well as the (EU) 10/2011 and (EC) 1935/2004 regulations regarding the raw materials used and the migration thresholds.

Halal

All Siegling POM Prolink modular belts are certified as being compliant with the Halal regulations by IFRC Asia (member of the World Halal Council).

Friction top

Siegling Prolink modular belts made of PE with Friction top material R7 and of PP with Friction top material R8 comply with FDA 21 CFR as well as the (EU) 10/2011 and (EC) 1935/2004 regulations regarding the raw materials used and the migration thresholds with the exception of contact to oily and fatty foodstuff.

Materials

PE (Polyethylene)

- very good chemical resistance to acids and alkalis
- very good release properties due to low surface tension
- good friction and abrasion behaviour
- extremely tough
- low specific weight

PP (Polypropylene)

- standard material for normal conveying applications
- quite strong and stiff
- good dynamic capacity
- highly resistant to acids, alkalis, salts, alcohols
- low specific weight
- no risk of stress cracks forming

POM (Polyoxymethylene/Polyacetal)

- very dimensionally stable
- very strong and stiff
- high chemical resistance to organic solvents
- lower drag
- very durable material
- hard, incision-resistant surface

POM-CR (POM cut resistant)

- highly resistant to impact and incision
- easy to clean
- minimal ridge formation
- low risk of material delamination

POM-HC (POM highly conductive)

- highly conductive material
- surface resistivity < 10⁶ Ω (according to specification)
- very strong and stiff
- very good friction and abrasion properties

POM-MD (POM metal detectable)

- material easily detected in metal detectors
- very strong and stiff
- very good tribological properties (friction and abrasion levels)

PA (Polyamide)

- good wear resistance in dry applications
- short-term temperature resistance up to 135 °C (275 °F)
- good fatigue resistance

PA-HT (Polyamide high temperature)

- material reinforced with fibre glass
- very high short-term temperature resistance up to 180 °C (356 °F)
- absorbs little water in humid environments
- very stiff
- durable

PXX-HC (self-extinguishing highly conductive material)

- flame retardant in line with DIN EN 13501-1 (C₄-s1 and DIN 4102 (B1)
- surface resistivity < 10⁶ Ω
- specially for use in the automotive industry

PBT (Polybutylenterephthalate)

- good wear resistance
- very good abrasive resistance
- good strength and stiffness
- not recommend for use in hot water > 60 °C (140 °F)

Siegling – total belting solutions

Committed staff, quality-orientated organisation and production processes ensure the constantly high standards of our products and services. The Forbo Siegling Quality Management System is certified in accordance with ISO 9001.

In addition to product quality, environmental protection is an important corporate goal. Early on we also introduced an environmental management system, certified in accordance with ISO 14001.



Forbo Siegling service – anytime, anywhere

The Forbo Siegling Group employs more than 2,000 people. Our products are manufactured in nine production facilities across the world. You can find companies and agencies with warehouses and workshops in over 80 countries. Forbo Siegling service points are located in more than 300 places worldwide.

◆ *Trolling Motor Owner's Manual*

See the following pages for the Haswing Cayman motor manual.



®

HASWING

船用推进器
用户手册
OWNER'S MANUAL

SYMA

致用户 To The Owner

感谢您选购“汉飞”电动船用推进器。其具有低噪音、无污染、操作性强、方便携带等优点，充分满足广大船舶爱好者的需求。我们衷心希望您能尽情体验水上娱乐的美好时光。

Thank you for choosing a Haswing electric trolling motor. It's designed for the purpose of superior performance, unpolluted and portable use. Enjoy your wonderful moment with Haswing trolling motor.

本用户手册包含正确安装，操作，保养等重要说明。为使推进器操作顺畅，建议用户在使用前应彻底理解手册上的内容及重要事项。如对手册上的操作或维护事项起疑问，请咨询汉飞客服中心。

This owner's manual contains information for proper installation, operation and maintenance. Be sure to thoroughly read and understand the contents before use. If you have any question about the operation or maintenance of your trolling motor, please contact Haswing customer service.

★ 为提高产品质量，我们欢迎广大用户给予评价及改进建议。
We welcome any comments on our product improvement.

为确保操作顺畅，防止意外发生，在用户手册及产品上注有特别符号信息。符号类别如下：

To avoid hazards and obtain great performance, special signs are noted in the owner's manual and on the product.



表示如不遵守指示可能导致操作人员及他人严重受伤或死亡。

Failure to follow the instruction could cause severe injury or death.



表示必须采取特殊措施以免推进器损坏。

Special precautions that must be taken to avoid damage to the motor.



表示使程序更容易，更快捷地完成。

Information that makes the procedures easier and faster.

目录

Contents

主要部件说明.....	1	
Product's features		
操作注意事项.....	2	
Before the operation		
安装		
Installation		
螺旋桨安装	3	首次安装前必阅
Installing the propeller		Read this page before install
电机鳍及提手安装.....	4	首次安装前必阅
Installing the lift-handle and fin		Read this page before install
船舶与电源安装.....	5	
Mounting the trolling motor and battery connection		
推进器操作方式		
How to operate the motor		
推进器的收与放操作.....	6	
Deploy and stow the motor		
遥控器使用说明.....	7-8	
Remote manual		
无线操控的连接与电源指示区.....	9-10	
Wireless control connection and Power Reader		
故障与修复.....	11-12	
Trouble shooting and solving method		
推进器电路图.....	12	
Electric circuit diagram		
维护与保养.....	13	
Maintenance		

主要部件说明

Product's features

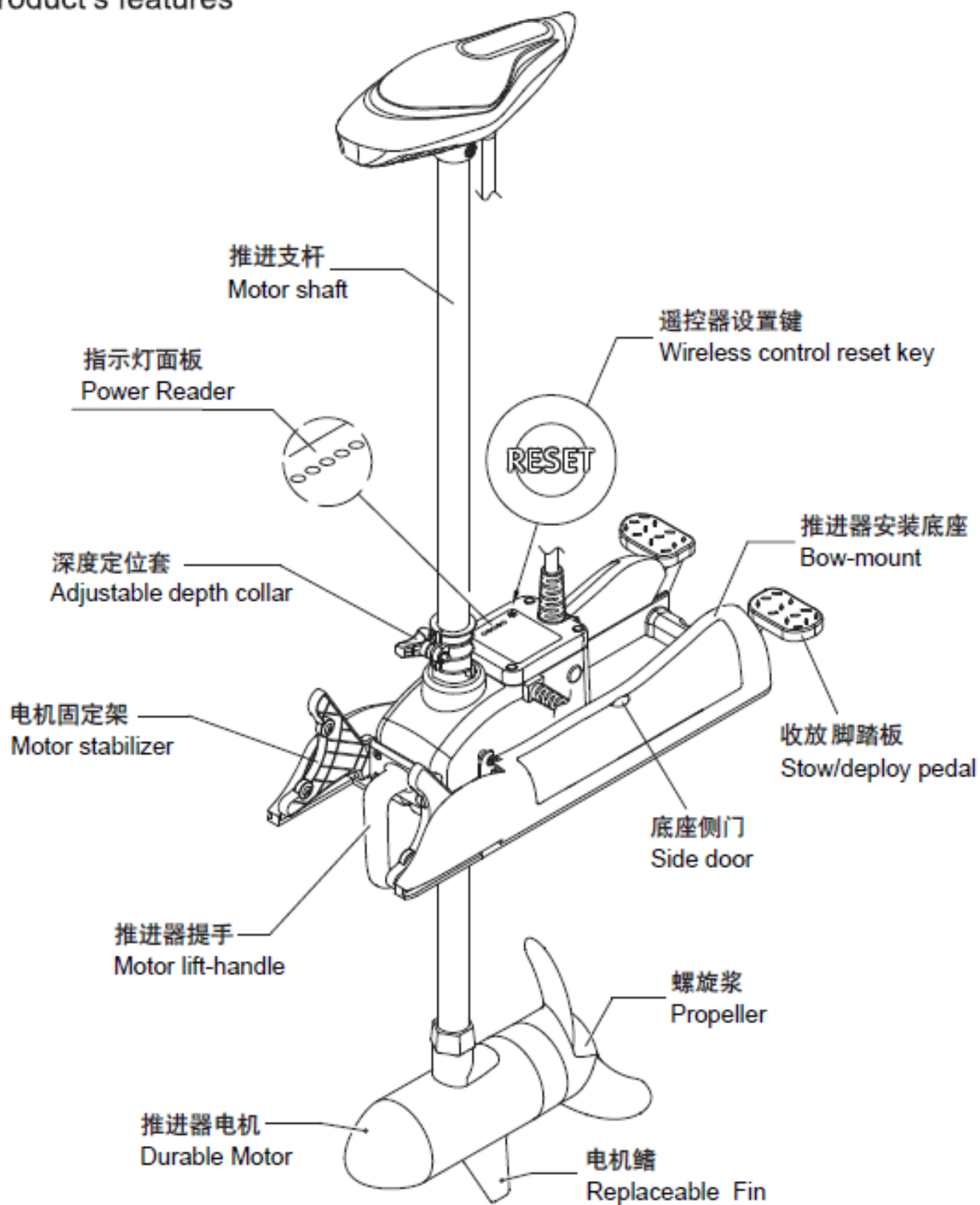

为提高该产品质量，我方保留对产品的更改权利。
We reserve the right to change parts without notice

操作注意事项

Before the operation

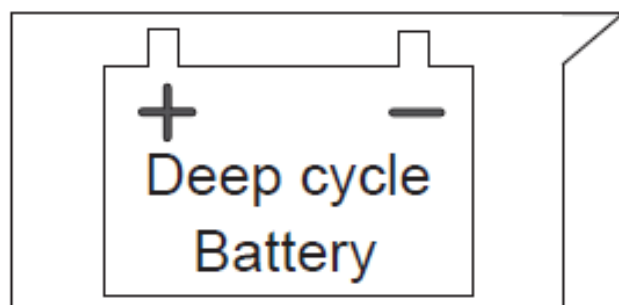

请使用深循环蓄电池。使用电压不符或不稳定的蓄电池可能会导致电机或电池的损坏。

Please use deep cycle battery for your motor. Improper use of battery would cause damage to the motor.

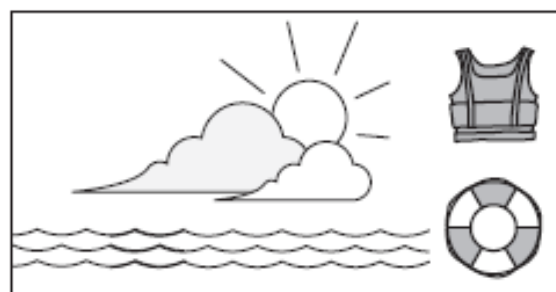

请勿在岸上接通电源或启动电机，以防意外发生。

Make sure the motor is battery disconnected during the onshore period.

用户应选择天气良好的时段活动，活动时应配备个人救生衣。

Personal life-jacket is needed at all time. And choose a good weather for your outdoor activity.

天气良好的时段活动
Weather condition



当船只进入浅水区或靠岸时，请关闭电机减慢航速，调整推进器与水面的角度，以免电机碰撞受损。

Turn the motor off to reduce the boat's speed. Tilting to prevent impact when enter to the shallow water area.

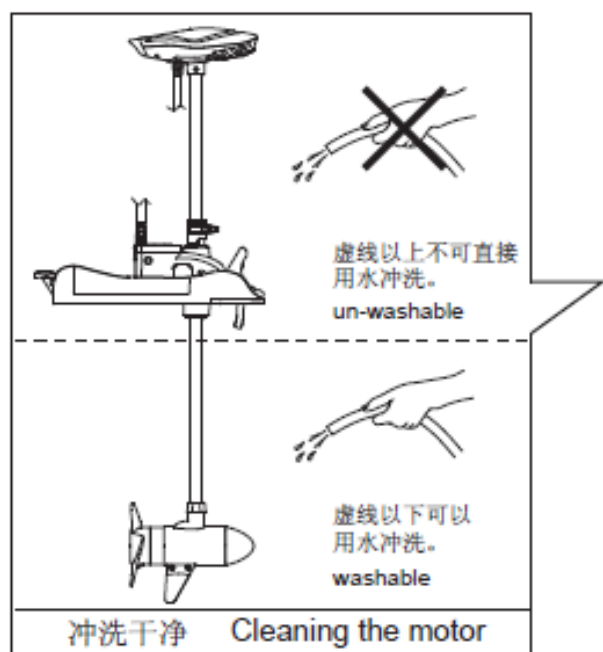

推进器运行时要留意游泳者以及周围环境。

Beware of the swimmer and your surrounding during the operation.

使用推进器后应清理螺旋桨上的杂物，用清水冲洗推进器。特别在海水中使用后要彻底冲洗干净。

Remove sundries from the propeller and wash off the motor, especially after the saltwater use.

冲洗干净 Cleaning the motor

1 螺旋桨安装

Installing the propeller



在安装更换及保养螺旋桨前必须断开电源。

Make sure the motor is disconnected from the battery before installing or replacing the prop.

1. 首先将螺旋桨固定销以水平方向穿进电机轴孔上，再把螺旋桨装入电机轴上（螺旋桨背面共有两个固定槽口成十字形分布，用户可随意选择一个槽口与固定销进行装配）。最后把阴极、不锈钢垫片和螺母套入电机轴上。（如图.1）

Install the drive pin into the shaft hole and align it with the propeller (The drive pin and the cross-shaped propeller groove must align horizontally). Install the Sacrificial Anode, stainless washer and nut into the shaft (figure.1) when the propeller is assembled.



螺旋桨背面共有两个固定槽口，如损坏其一，用户可卸下螺旋桨更换至另一个。

The cross-shaped groove (2 grooves) allow user to reassemble the propeller if one groove is worn off.



图.1
figure.1

2. 用手握住螺旋桨叶的一端以防转动。用专用扳手使螺母固定螺旋桨。（如图.2）

Hold the propeller to prevent it from revolving and use the propeller wrench to tighten the propeller nut. (figure.2)

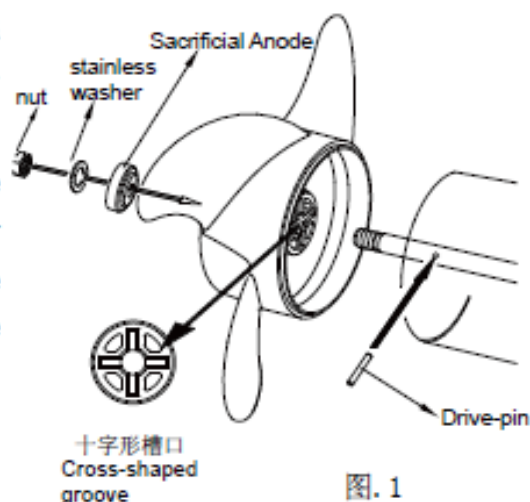

请使用我司提供的专用工具或配备一把7mm扳手作安装用途。（切勿使用其它不恰当的工具以免损坏配件）

Use the propeller wrench supplied or 7mm wrench for the installation. (The use of inappropriate tools may cause motor damage)



安装螺旋桨时应适当拧紧螺母（当螺母贴底后再上紧1/4圈）。过度的紧配会使螺旋桨及固定销损坏。

Tighten the prop nut 1/4 turn past snug.(30 inch lbs.) over tightening the prop nut can damage to the prop.



图.2
figure.2

2 提手及电机鳍安装

Installing the lift-handle and fin

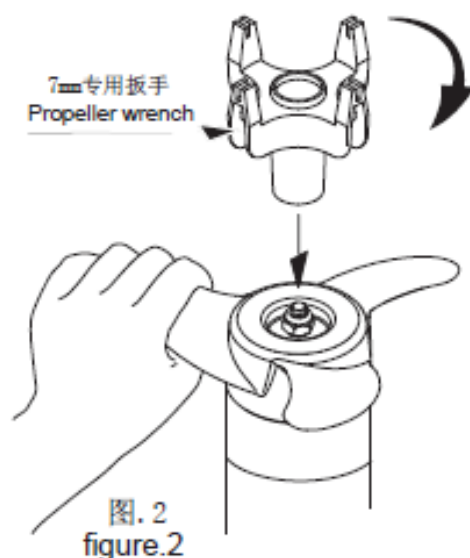

在安装零件前必须断开电源。

Make sure the motor is disconnected from the battery before installing the accessories.

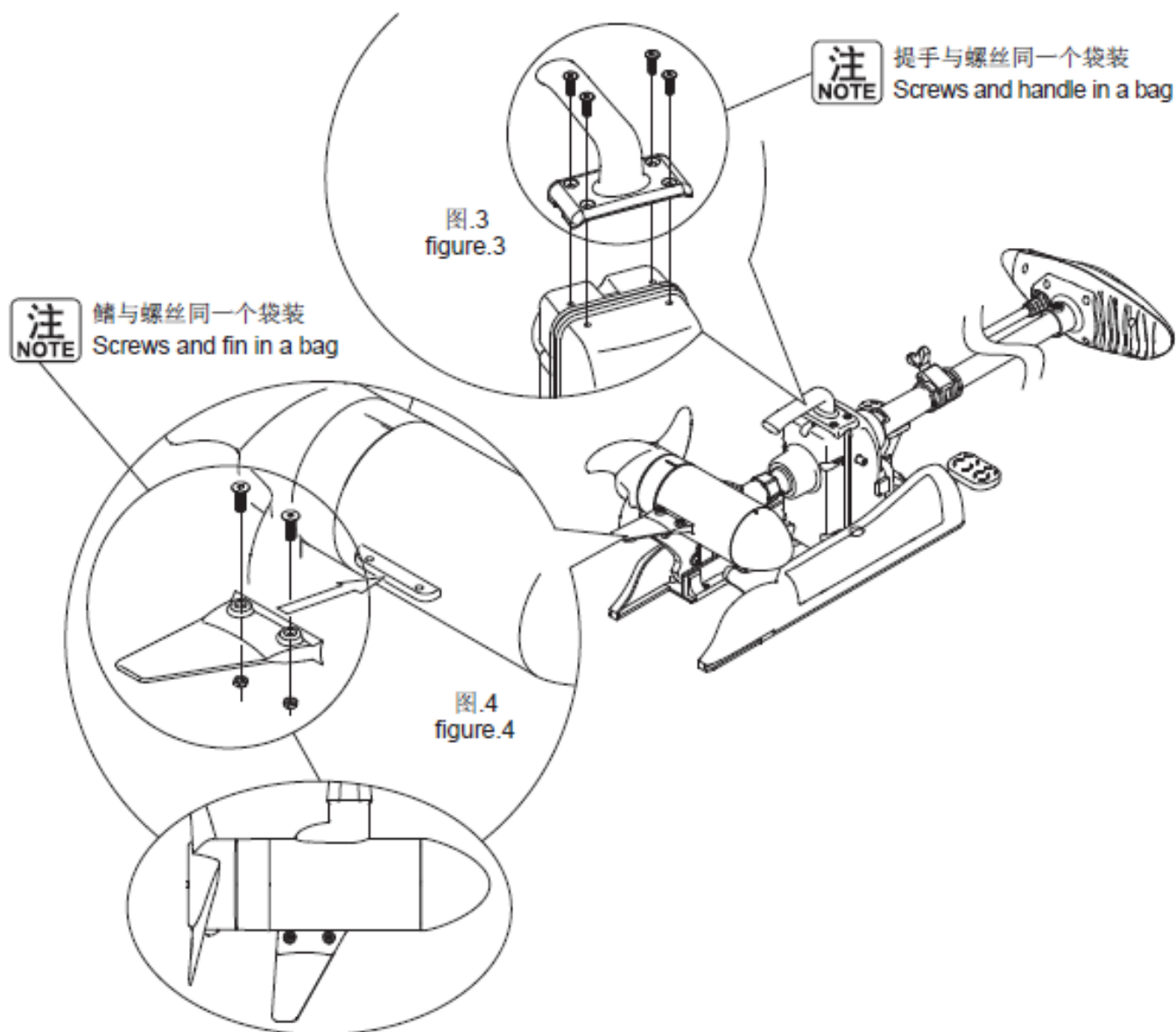

1. 把提手放在齿轮箱上对准该螺丝孔位后打上螺丝固定。(注意:请按图进行装配。如图.3)

Aligns the lift-handle on the gearbox,install it with four handle-screws. (figure.3)

2. 把电机鳍插进电机上的固定位置对准螺丝孔装上螺母打上螺丝固定。(注意:请按图进行装配。如图.4)

Aligns the motor-fin on the motor,install it with two fin-screws. (figure.4)

3 推进器的安装

Mounting the trolling motor



警告 请勿在安装及卸载推进器时接通电源或启动电机，以防意外发生。

Make sure the motor is battery disconnected during the mounting and dismounting or onshore period.

请将推进器定位在船头板的中段位置，并用安装螺丝固定。（如图.5）

Aligns the motor on front of the boat and tighten with bow-mount screws and rubber washers. (figure.5)



图.5
figure.5

4 电源安装

Battery connection

选择合适电源 — 请使用深循环蓄电池。使用电压不符或不稳定蓄电池都可能导致电机或电池的损坏。

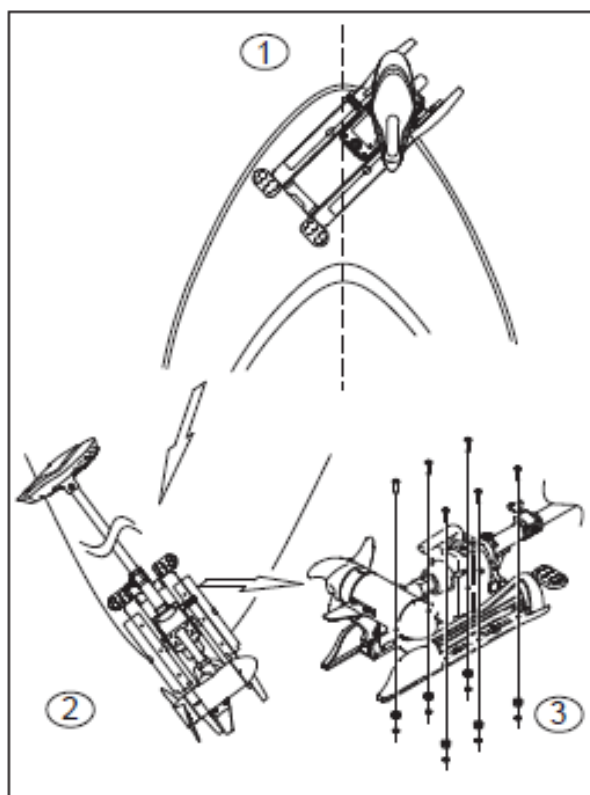
Select a compatible battery — Please use deep cycle battery for your motor. Improper use of battery would cause damage to the motor.

连接电源 — 请将红色 (+) 正极电源线末端连接至电池的正极处 (+)，黑色 (-) 负极电源线末端连接至负极处 (-) 并固定。（如图.6）

Connecting the battery — connect the red motor cable (+) to the positive battery terminal (+), black cable (-) to the negative terminal (-) and fasten it. (figure.6)

把电池放置在通风干爽的位置。

Put the battery in a ventilated place.



图.6
figure.6

操作方式

How to operate the motor

1. 推进器的收与放操作

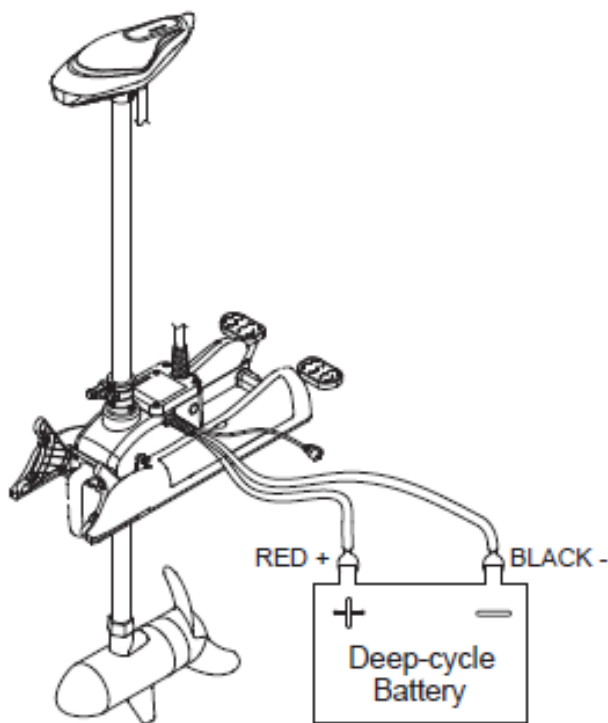
Deploy and stow the motor

投放推进器

Deploy the motor

踏下收/放脚踏板并将电机投入水中至0度，连续“蜂鸣短响5声”推进器开机。（如图.7）

Press the stow/deploy pedal and deploy the motor to the water. (figure. 7)

收回推进器

Stow the motor

握住推进器的支杆并同时踏下收/放脚踏板，提起电机至90度并将其扣入电机固定架上推进器关机。（如图.7）

Press the stow/deploy pedal and stow the motor out from the water. (figure.7)



图.7
figure.7



警告

在推进器的收与放操作中，请勿把手放进机械旋转关节处。

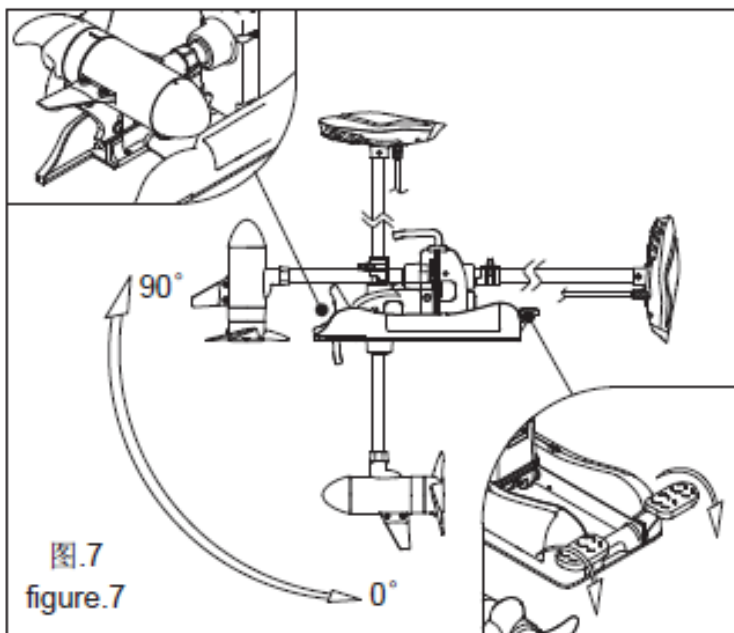
When raising or lowering motor, keep fingers clear of all hinge and pivot points and all moving parts.

2. 推进器的吃水深度

Adjust the motor depth



警告

在调节吃水深度前，请先握住电机支杆以免电机滑落。

Hold on to the motor shaft before adjust the motor depth avoid motor slide.

松开深度定位套上的螺栓。然后慢慢往下放或上提将电机调节至合适的吃水深度再上紧螺栓固定。（如图.8）

Adjust the motor depth by unscrew and tighten the depth collar. (figure. 8)



图.8
figure.8

3. 遥控器按钮使用说明 Remote manual

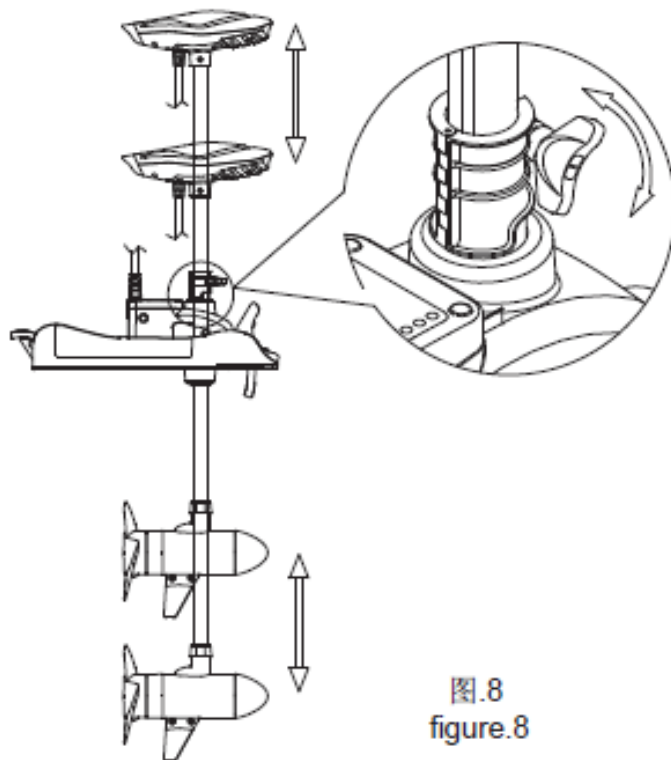

在安装或更换遥控器电池前必须断开推进器电源。

Make sure the motor is battery disconnect before replace remote-battery.

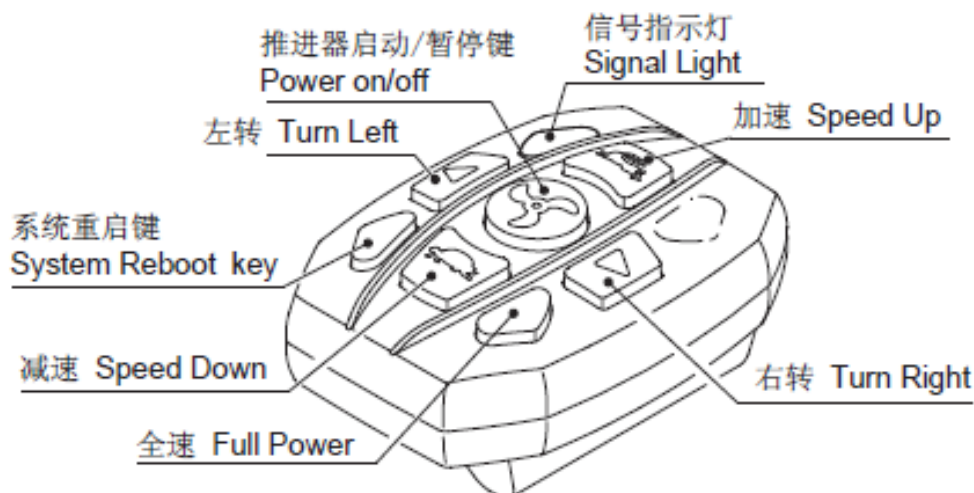

4. 遥控器信号指示灯 Signal light

在使用遥控器时, 按每一个键信号指示灯都会亮, 说明操作命令已成功发射。(如图. 9)

Signal light flash when press any remote-key, it means signal transmit successfully. (figure.9)

注 如按下操作键时信号灯不亮, 表明电池的电量过低, 需更换电池。
NOTE Replace the remote-battery when there is no signal light.









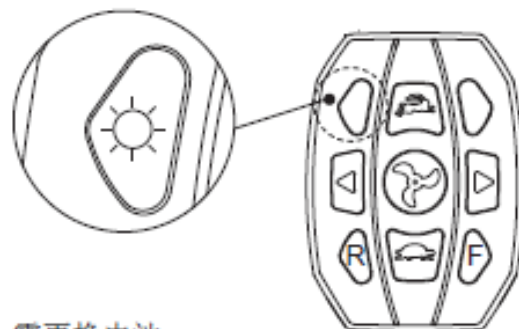

图.9
figure.9

5. 操控推进器的速度 Speed control

首先按一下  键激活推进器“峰鸣器短滴一声”, 按  或  键来调节推进器的航速“峰鸣器短滴一声”。如要停止推进再按一下  键取消推进“峰鸣器短滴二声”。(如图. 10)

Press  to activate the motor "1 beep". press  or  to adjust the trolling speed "1 beep". to stop the motor by pressing  to cancel "2 beep" .(figure.10)



图.10
figure.10

6. 操控推进器的转向

Turning the trolling motor

按一下  或  键时推进器会按照对应的命令转向 (如图. 11)

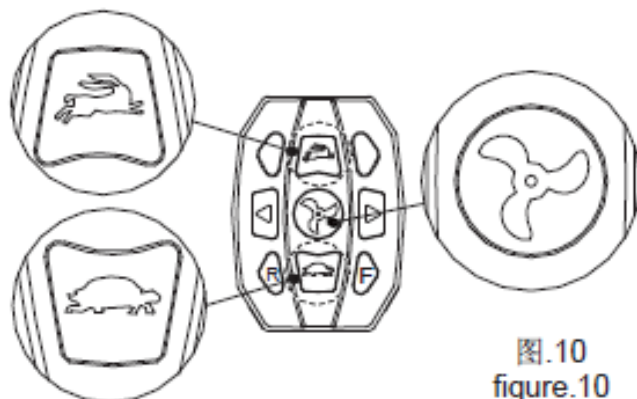
Press  or  to turn the motor left or right (figure.11)







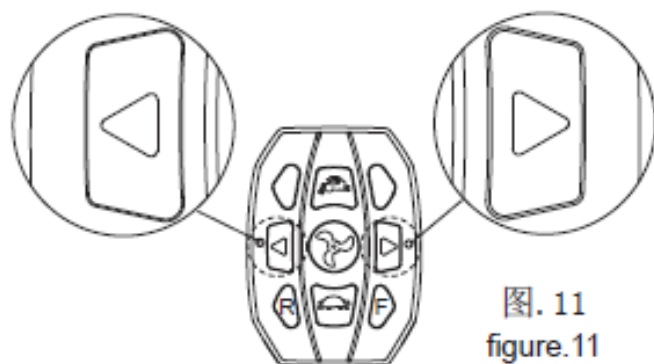

图. 11
figure.11

7. 全速与刷新键的使用

Full speed and system reboot key

首先按一下  键激活推进器“蜂鸣器短滴一声”，再按  使推进器全速运行“蜂鸣器短滴一声”。如再按一次  推进器复回原速度。“蜂鸣器短滴二声”。(如图. 12)

Press  to activate the motor "1 beep". press  to change to full speed "1 beep". Back to the previous setting by pressing  "2beep". (figure.12)





图. 12
figure.12

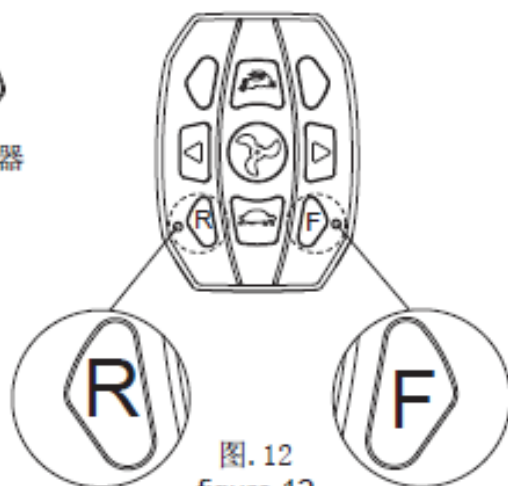

如在使用中发现推进器控制失效，可按一次  机器停止运作系统刷新重启。“蜂鸣器短滴二声”(如图. 12)

Press  to reflash the control system if the function is disorder "2 beep". (figure.12)

8. 遥控器的固定带

Remote strap

将固定带穿在遥控器上，便可把遥控器固定在渔杆上。(如图. 13)

Install strap to the remote (see figure.13) and tighten it on the fishing rod.









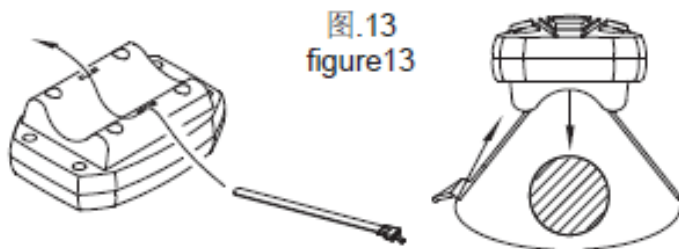

图. 13
figure.13

9. 遥控器与推进器的连接

Wireless control connection

按住电源指示区下的  键（如图. 14）。再按一下遥控器上的  键，当听到“蜂鸣短响3声”，即说明遥控器对码储存成功，松开  键和  键后推进器可立即使用。

Press and hold  below the power reader (figure.14) then press  on the remote to build the signal connection. " 3 beep" indicate connection established. release  and  both system is ready.





图.14
figure.14

10. 断开推进器的遥控连接

Erase all the wireless connection

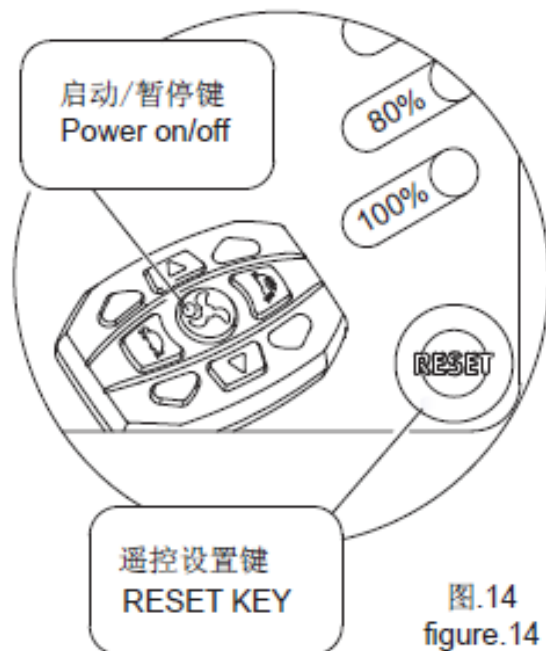
停止运转推进器，按下  6秒当听到“蜂鸣长响2声”，说明推进器的所有遥控对码已删除。（如图. 14）
Stop operate the motor, press and hold  for 6 sec. " 2 long beep " indicate wireless connection all erase.(figure.14)

注意 操作故障指示
CAUTION Operation error indication

本机还设有“操作故障检测功能”。如因使用不当导致故障时，推进器会自动停止运转，并响起相对应的蜂鸣响声。这时应对推进器进行相对应的检查。（详情请阅故障与修复部分P. 11-12）

This motor has an operation error self-detect function. motor will shut down automatically and the corresponding audio pattern "beep" start if operation errors occur. (Please read the trouble shooting further details see pag.11-12)

11. 遥控器电池安装步骤 Replace new battery

请按照装配步骤用螺丝刀卸开遥控器,并更换电池。(如图. 15)

See (figure.15) to replace new battery.



图.15
figure.15

12. 电源指示区 Power Reader

推进器上设有一个检测电源的指示区。满电时所有电源指示灯亮着。当电量降低时，电源指示灯组的灯会从上往下灭。当电源指示灯剩下最后一盏时（电量为20%），建议给与蓄电池充电。（如图. 16）

The motor has a battery's power reader to display the battery level. "Full light" indicates a full power charge condition. The light will go off when the power is continue to decline. Please recharge the battery when it declines to the last light (20% of battery's power). (figure.16)

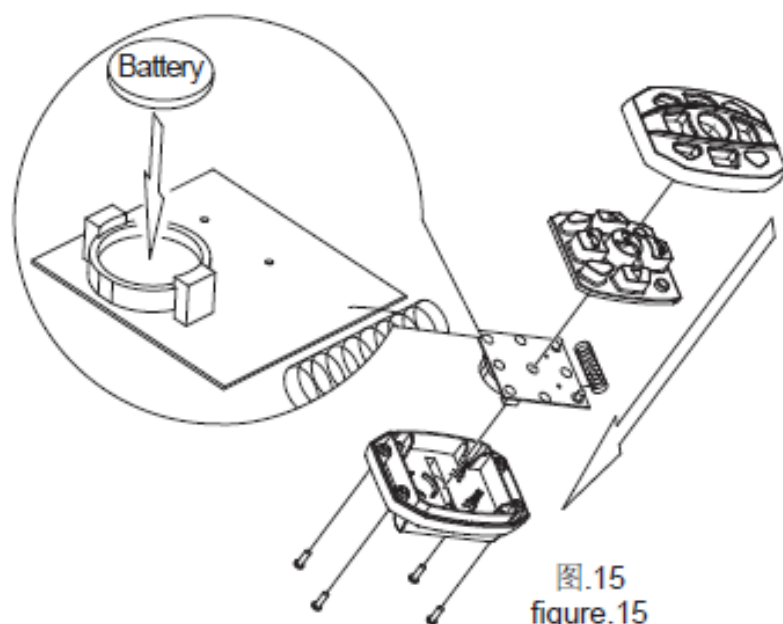

图.16
figure.16



本机设有电池电量保护功能，当电量过低时不接受任何信号推进器连续“蜂鸣短响”推进器自动关机。

When the power of battery is low, the motor will shut down itself automatically to protect the life span of battery."continuous beep"

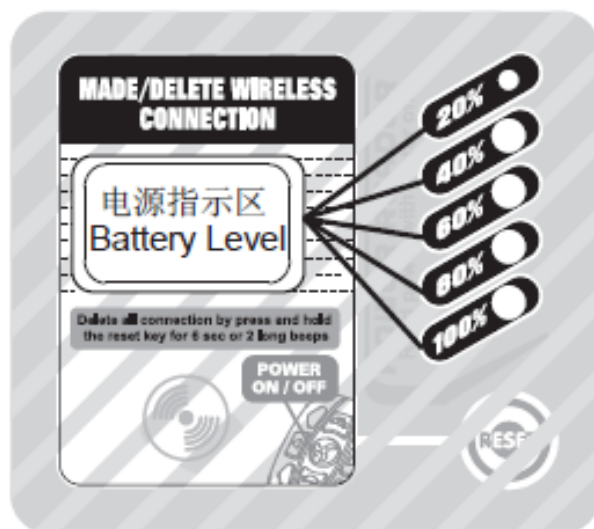
故障与修复

Trouble shooting and solving method

1. 电机运行艰难或停止运作

Motor fails to run or lack of power

查看电源是否按正确方式牢固连接。

Make sure the motor cable is connected properly.

如发现蓄电池与主电源线的接触点附着异物或生锈，应当给予清洁。

Check the cable terminals clean and corrosion free.

查看蓄电池电量是否充足。如电量过低时请充电。

Make sure the battery is full. Please recharge it when the battery's empty.

检查螺旋桨是否被线或水草缠绕。如有异物阻塞螺旋桨内部，请卸下螺旋桨进行清洗。（“警告”清理螺旋桨时请先切断电源）

Make sure there is no fishing line or weeds caught up in the propeller. Please detach and clean up the propeller if there is sundries got caught inside the prop. (WARNING: Make sure the motor is disconnected from the battery)

检查螺旋桨固定销是否损坏。

Make sure the propeller drive pin is still in good condition.

2. 推进器噪音大或晃动大

Motor vibration

检查螺旋桨是否安装牢固。

Make sure the propeller is installed properly.

查看螺旋桨及其固定销是否弯曲变形，如损坏严重建议更换配件。

Inspect the propeller and the drive pin conditions, replace it if necessary.

断开电源，用手转动螺旋桨，如受到阻碍或卡住，表明电机内部可能受损。请停止使用并联系汉飞客服中心。

Disconnect the battery cable and examine it by turning the propeller manually, motor shall turn freely with a slight magnetic drag. Internal damage might occur if motor is blocked or locked. Stop use it and contact our customer service

3. 操作故障指示

Operation error indication

大电流保护——如连续“蜂鸣长响”推进器停止运作，表示螺旋桨受阻。请检查是否超载或被钓鱼线，水草缠绕。如有异物阻塞螺旋桨内部，请卸下螺旋桨进行清洗。

"continuous beep" indicates the power output overload. please make sure the total weight of the boat is not overload or make sure there is no fishing line or weeds caught up in the propeller, detach and clean the propeller if there is sundries got caught inside the prop.

低电压保护——当电源电压不足时（指示灯区剩下20%的红灯）连续“蜂鸣短响”，推进器自动关机。这时需更换电池或重新充电。

When the power of battery is low, the motor will shut down itself automatically to protect the life span of battery "continuous beep". Please recharge or replace the battery.

推进器转向电流保护——如“蜂鸣长响4声”转向停止，表示转向系统受阻保护，请检查推进器支杆上是否附有异物，检查在水中电机是否受阻。

If the turning function does not work and "4 long beep" it means the corresponding action block. please check and clear away the obstruction.

4. 蜂鸣模式

Audio Pattern

蜂鸣模式对照表

蜂鸣模式	蜂鸣响声说明
短响1声	操作命令接收成功
短响2声	停止操作命令或返回原设置
短响3声	遥控器与推进器连接成功
短响5声	推进器已开机
连续短响声	电池电量不足状态
长响2声	清除所有遥控器连接
长响4声	转向系统保护
连续长响声	推进电机大电流保护

AUDIO PATTERN TABLE

AUDIO PATTERN	CONDITION
1 beep	operation signal received
2 beep	stop operation or return to the original settings
3 beep	wireless setting connected
5 beep	system ready
continuous beep	low battery warning
2 long beep	all wireless connection deleted
4 long beep	turning function block
continuous long beep	overload current

★ 如有其它问题，请与汉飞客服中心联系。

For all other malfunctions not listed above, please contact Haswing customer service center.

5. 推进器电路图

Electric circuit diagram

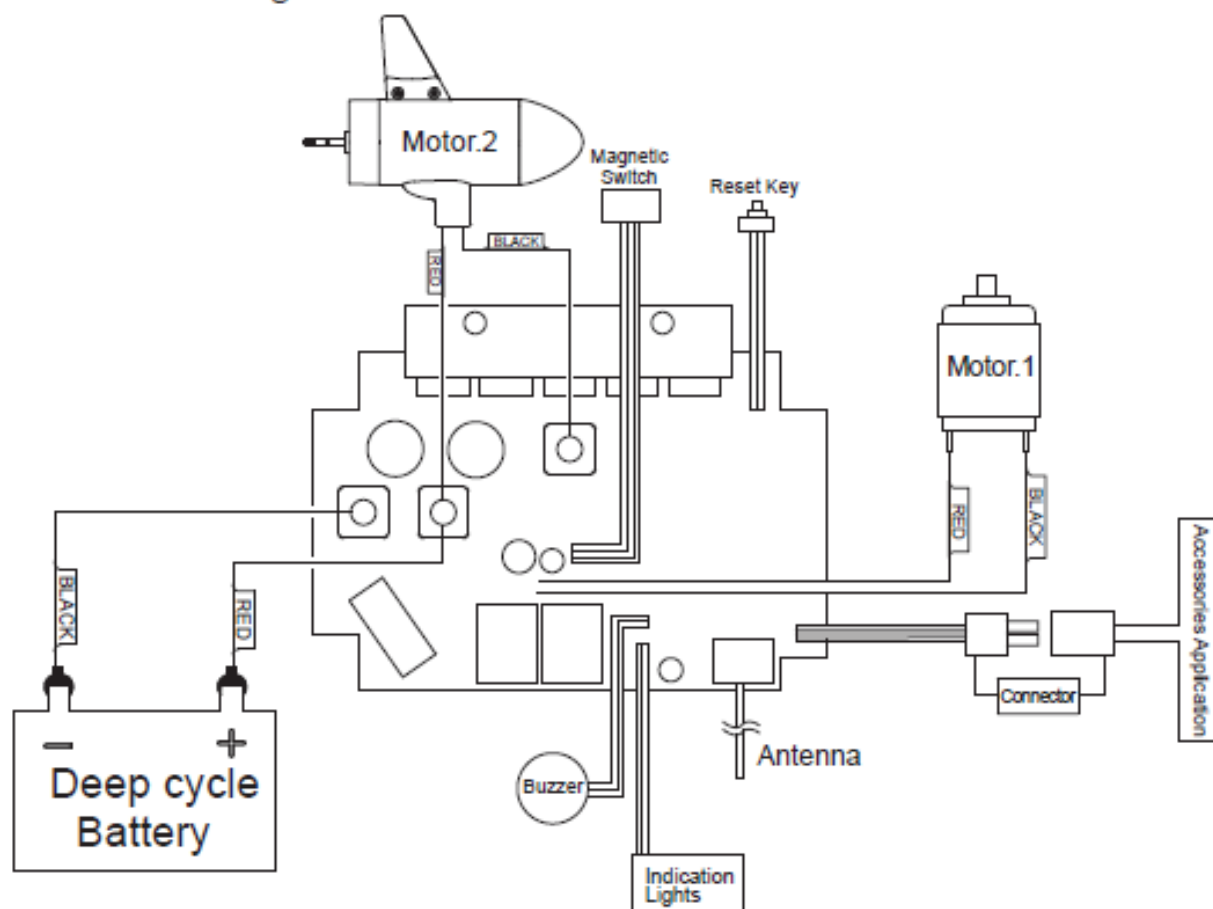

维护与保养 Maintenance

1.在推进器每次使用后应该按说明书要求冲洗保养，冲洗过后应保持整洁，因不当使用导致电机表面腐蚀或损坏属保修无效。（请参考P.2）

Please wash and clean the motor and propeller intensively after use as per manual, caused by improper use of surface corrosion or damage to the motor is not covered by the warranty. (Refer to P.2)

2.每次使用后，用水彻底冲洗，将附着螺旋桨的线，水草和阻塞于螺旋桨内部的杂物等清洁干净。

（清洗部位请阅P.2“冲洗干净”）

Clean up all the sundries on or inside the propeller after every use. (Please see P.2 "cleaning the motor")

3.用户应定期对各个活动关节部分给予润滑，使用专业工具（如：螺丝刀，板手等）调紧松脱的部位。

Apply lubricant to the turning parts regularly and use proper tool fasten the parts.

4.使用后应在电池与主电源线的连接处上给予防锈处理。

Apply rust prevention to the cable and battery terminals after every use.

5.请把推进器存放在干爽通风的环境下。

Store the motor in a good ventilated place and keep it dry.

6.请勿在环境复杂的水域里使用，以免损坏推进器。

To avoid hazards, do not use the motor in the intricate water.

7.请勿使推进器受重压或撞击。

Do not crashing or put weights on top the motor.

8.本产品纯属户外娱乐设备。用户不得将其作为长时间长距离或超负荷营运使用。

This motor is designed for outdoor amusement only. Continuous long distance transport is not permitted.

雅 太 电 器 有 限 公 司

Yatai Electric Appliances Co.,Ltd.

地址：中国广东省中山市三乡镇南龙工业区新龙街四号

Add:No.4 Xinlong St.Nanlong Industrial Park,
Sanxiang, zhongshan,guangdong,China.

邮编/Postcode:528463

电话/Tel:+86 760 86691616

传真/Fax:+86 760 86691626

WWW.HASWING.COM

Printed in China 50700 V02

► APPENDIX E – DFMEA

Process Failure Mode and Effects Analysis (PFMEA)																
Preoperative Verification Process Analysis										Actions		Outcomes				
ID	Process Step	Failure Mode	Potential Effects of Failure	Severity	Potential Causes of Failure	Occurrence	Current Controls	Detection	RPN	Response (Eliminate, Mitigate, or Accept)	Preventive and Corrective Actions	Severity	Occurrence	Detection	RPN	
1	Gluing and assembling PVC	PVC pontoons get a leak	Boat sinks	5	PVC pieces not all the way in joints	4	None	4	20	Eliminate	switch to inflatable pontoons	5	1	1	5	
				5	Glue doesn't make a perfect seal	3	PVC glue	5	15	Eliminate	switch to inflatable pontoons	5	1	1	5	
				5	Joints bend and glue becomes detached	4	Frame holding PVC together	2	20	Eliminate	switch to inflatable pontoons	5	1	1	5	
2	Fabricating aluminum frame	Frame isn't strong enough and breaks or bends	Boat falls apart	4	Inadequate welds due to lack of experience welding aluminum	4	Welding frame ourselves	4	16	Eliminate	Cut and mill pieces of the frame ourselves, but get the welds done at a machine shop	4	1	4	4	
				4	Frame experiences a lot of force from moving it or being sat on	3	Aluminum L-Beams	4	12	Mitigate	switch to curved L-Beams to increase the strength of frame	4	1	4	4	
Total Risk Priority Number =										83	"After" Risk Priority Number =					23

► APPENDIX F – ACCOUNTING

The following page contains the list of purchases with summaries of the type and materials. The totals listed in the “Satisfaction of Requirements” tables are from this list. Note that this list also includes the materials that we did not use in the end (PVC assembly materials).

There may be a few more purchases in the following days as we widen the plow and take care of other odds and ends before delivering the product. However, this list constitutes the bulk of the project.

Purchase	Item	Usage Description	Cost	Date
1	Anatek Lab Water Testing for Nitrate, Ammonia, and Orthophosphate	Water Testing	\$120	11/9/2016
2	8" Schedule 40 PVC 90 Elbow Socket, 406-080 8" x 10' Plain End Schedule 40 PVC Pipe	PVC	\$518.82	1/17/2017
3	8 piece Aluminum 6061-T6 Bare Extruded Angle Structural 1.5" x 1.5" x 0.125"	Frame Metal	\$176.58	2/6/2017
4	18-8 Stainless Steel Hex Head Screw 1/2"-13 Thread Size, 1-1/2" Long, packs of 10 18-8 Stainless Steel Hex Nut 1/2"-13 Thread Size, packs of 25 Weather-Resistant EPDM Rubber Sealing Washer for 1/2" Screw, 0.49" ID, 1.062" OD, 0.078"- 0.108" Thickness,	Screws for Attaching PVC	\$31.85	2/6/2017
5	36X84 Pet-D-Fence Screen, 100CT Black 8" 18LB Ultra Light Duty, 2-3/8IN Kit Grommet, 2 Square Aluminum Tube 1X4', Utility Fit Foam Board	Plow and PVC Support	\$90.23	2/15/2017
6	8 Tube Square Aluminum 1X4'	Plow	\$119.92	2/22/2017
7	Sea Dog Stainless Steel Butt Hinge X4	Plow Component	\$44.31	2/28/2017
8	4 pieces Aluminum 6061-T6 Bare Extruded Angle Structural "1.5" x 1.5" x 0.125" 4 pieces @ \$6.62/piece Aluminum 6061-T6 Bare Extruded Angle Structural "1.25" x 1.25" x 0.125" 1 piece @ \$3.38/piece Aluminum 6063-T52 Bare Extruded Angle "2" x 2" x 0.125" +more	Conveyor Frame	\$133.05	2/28/2017
9	2 pieces Aluminum 6061-T6 Bare Extruded Angle Structural "1.5" x 1.5" x 0.125"	Conveyor Frame	\$39.08	3/21/2017
10	2 Aluminum Extruded Angle Structural 1.5X1.5X.125"	Frame	\$39.08	3/21/2017
11	Utility Fit Foam Board 1"X4'X8'	PVC Support	\$18	3/24/2017
12	Hose Clamp Bands	Attaching PVC	\$26.99	3/30/2017
13	Tarp Clips and Utility Cords	Pontoon/Frame	\$22.02	3/31/2017
14	Spray 2x GLS NAVY Blue Paint, Primer, Paint	Frame	\$22.36	3/31/2017
15	Caymon B 55 lbs Electric Motor Bow Mount and 2 Mount Brackets	Power	\$440	4/6/2017
16	Marine/RV Deep Cycle Battery	Power	\$89.99	4/6/2017
17	Core Frame Weld	Frame	\$106.25	4/10/2017
18	24 Fasteners	Frame	\$5.08	4/11/2017
19	12 Volt 100 Watt Electric Motor, Chain Sprocket 90	Conveyor	\$72.96	4/12/2017
20	DC Motor Speed Control 12 VDC to 40 VDC PWM	Conveyor	\$21.12	4/12/2017
21	Custom Conveyor Belt and Sprocket	Conveyor	\$1,064.29	4/13/2017
22	Roanoke Pontoon Boat, 2 Aluminum Tubes 1X1X1/16"	Pontoon/Frame	\$274.57	4/13/2017
23	Clamping Shaft Collar: 1/2" Diameter	Conveyor	\$50.99	4/13/2017
24	Battery Box	Frame Accessory	\$14.29	4/17/2017
25	Small Battery Box	Frame	\$14.29	4/17/2017
26	Fasteners	Frame	\$24.59	4/19/2017
27	8 Bolts, washers, and nuts	Conveyor Bolts	\$24	4/21/2017
28	Mundy's Machine shop square tube motor attachment	Addon to Frame	\$144.89	4/21/2017
29	Fasteners, Wire, and Strap Bulk	Frame	\$24.04	4/21/2017
30	Alum Sq. tube 1 1/2x1, 1/2x1/8	Frame Attachment for Pontoons	\$43.23	4/25/2017
31	16 Fasteners	Frame	\$7.83	4/26/2017
32	5 Fasteners	Frame	\$2.48	4/26/2017
33	Alum Sq. Tube 1 1/2x1, 1/2x1/8, Alum Sq. Tube 1x1x1/16"	Frame	\$76.80	4/27/2017
34	Fasteners	Frame	\$65.51	4/27/2017
35	Fasteners	Frame	\$19.49	4/27/2017
36	Expo Poster	Project	\$72.80	4/27/2017
37	Conveyor Lower Support Weld	Conveyor	\$20	5/3/2017
38	Fasteners	Conveyor	\$24.80	5/5/2017
39	Painting Supplies	Paint	24.08	5/5/2017
40	Straps for chair, snaplinks for basket	Frame	51.04	5/5/2017
		Total:	\$4,181.74	