

# Power Lab Motor Design and Experiment

---

**PROJECT**





Team name

pursuers

Team members

Yuanchen Yan



Jintong Zhang



Almutairi Khalid





# Goal

Design a variable frequency power generation system that can provide power for various experiments within the power lab.

# Timeline

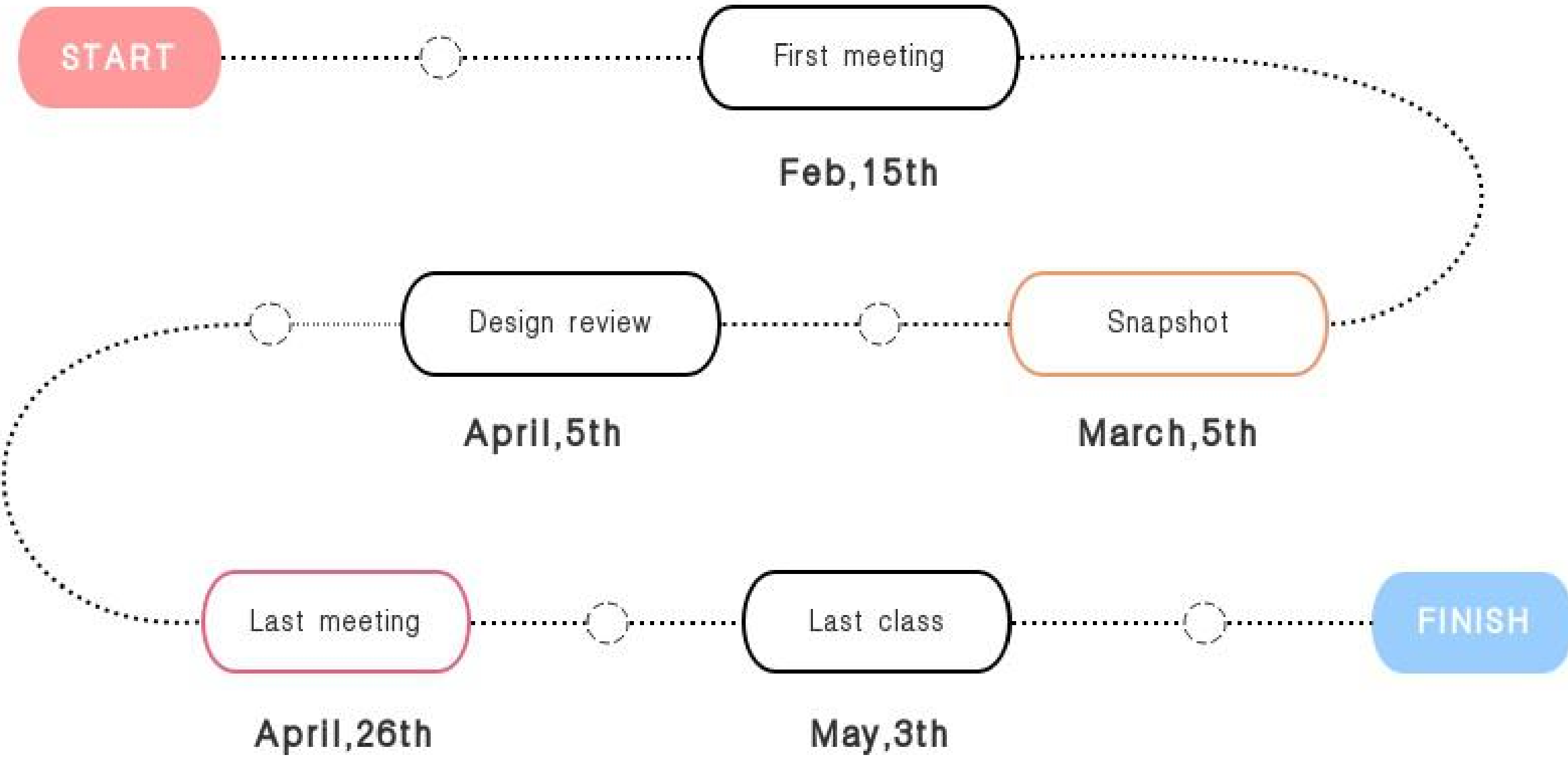



# Things we did this semester

01

Understand the project

02

Get Familiar with the machines

03

Modeling the machine

04

Doing the experiments



# Machines

---

# Machines

Three-phase Induction Motor:

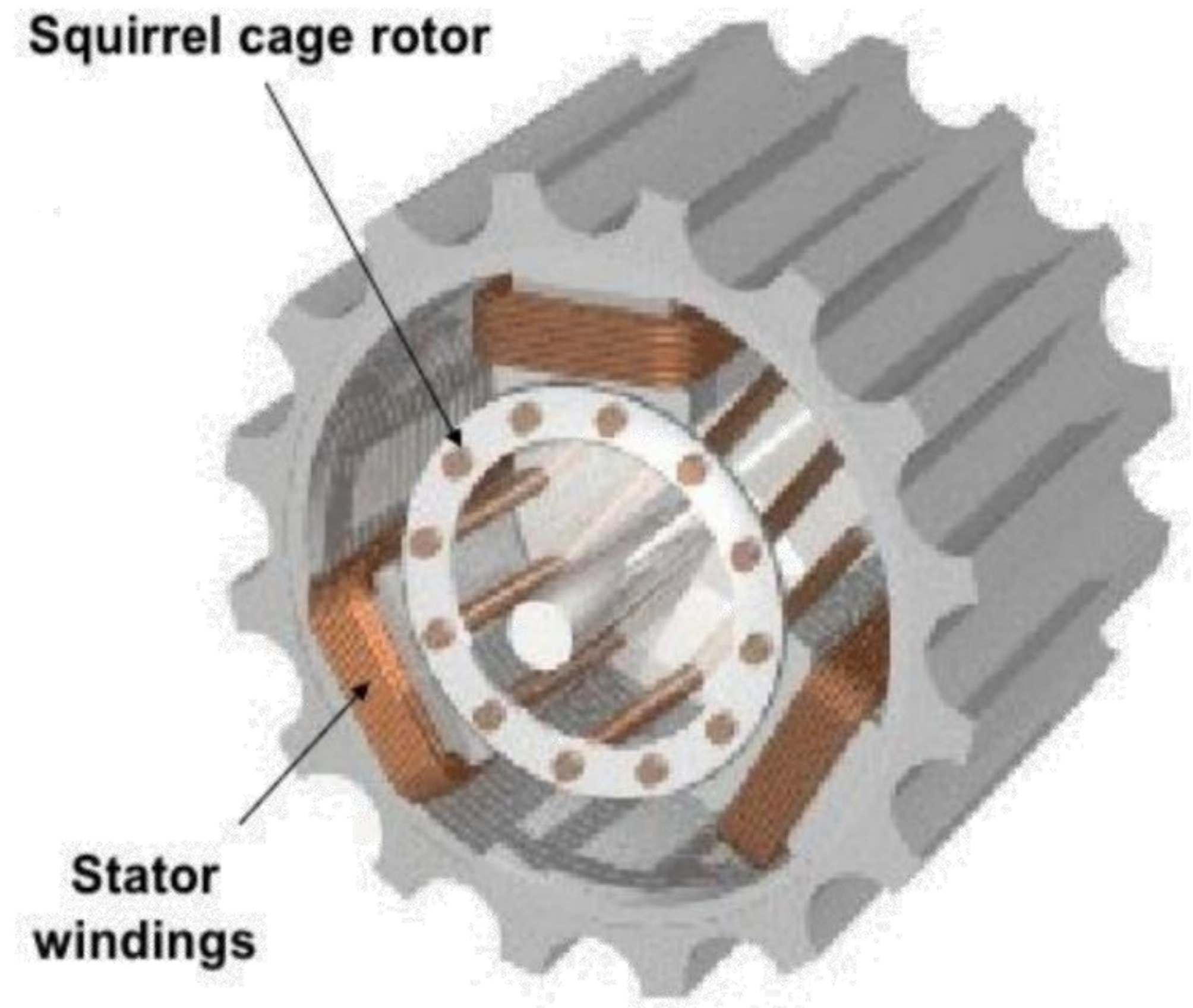

# Synchronous Machine

Stator containing armature windings

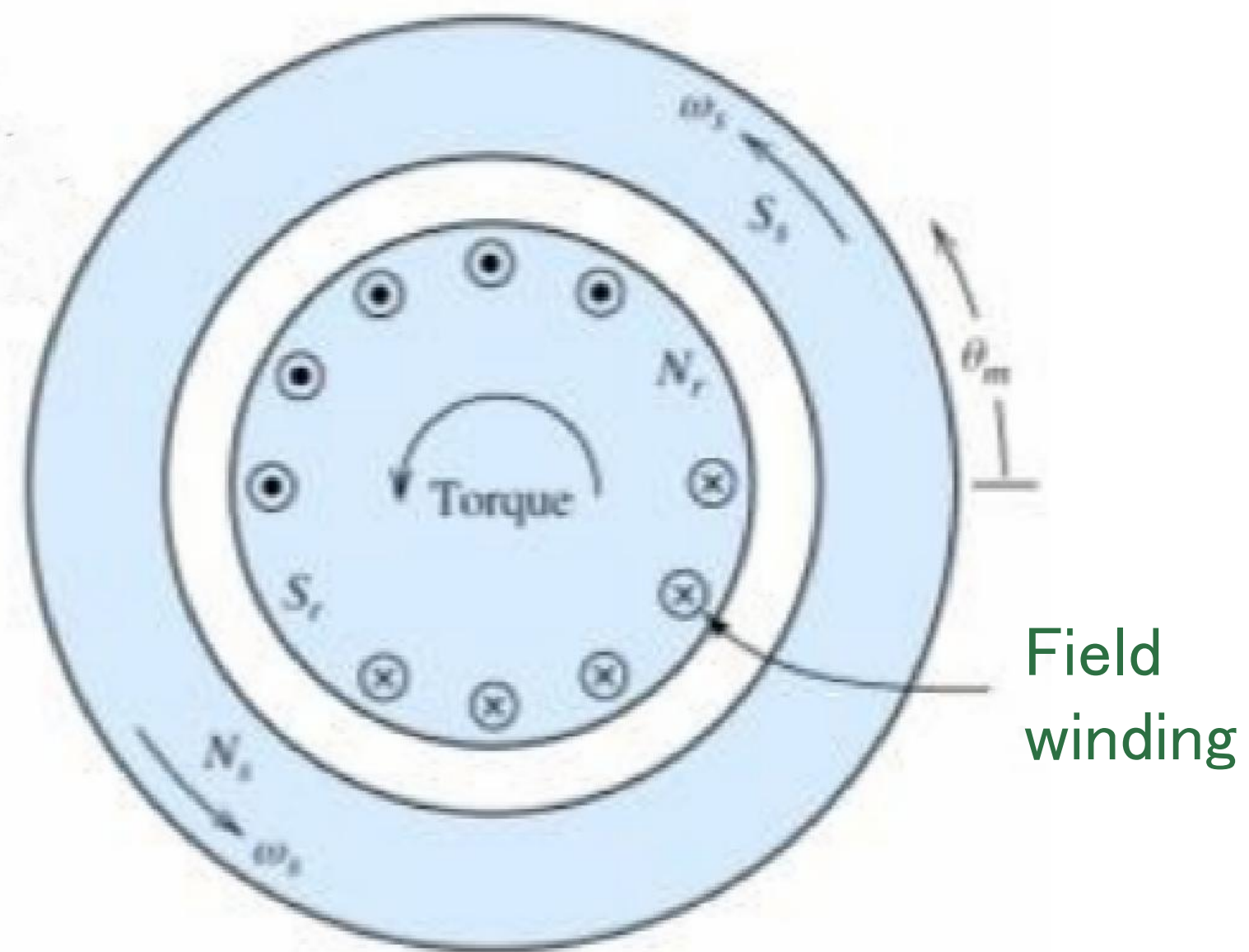

two-pole cylindrical rotor machine

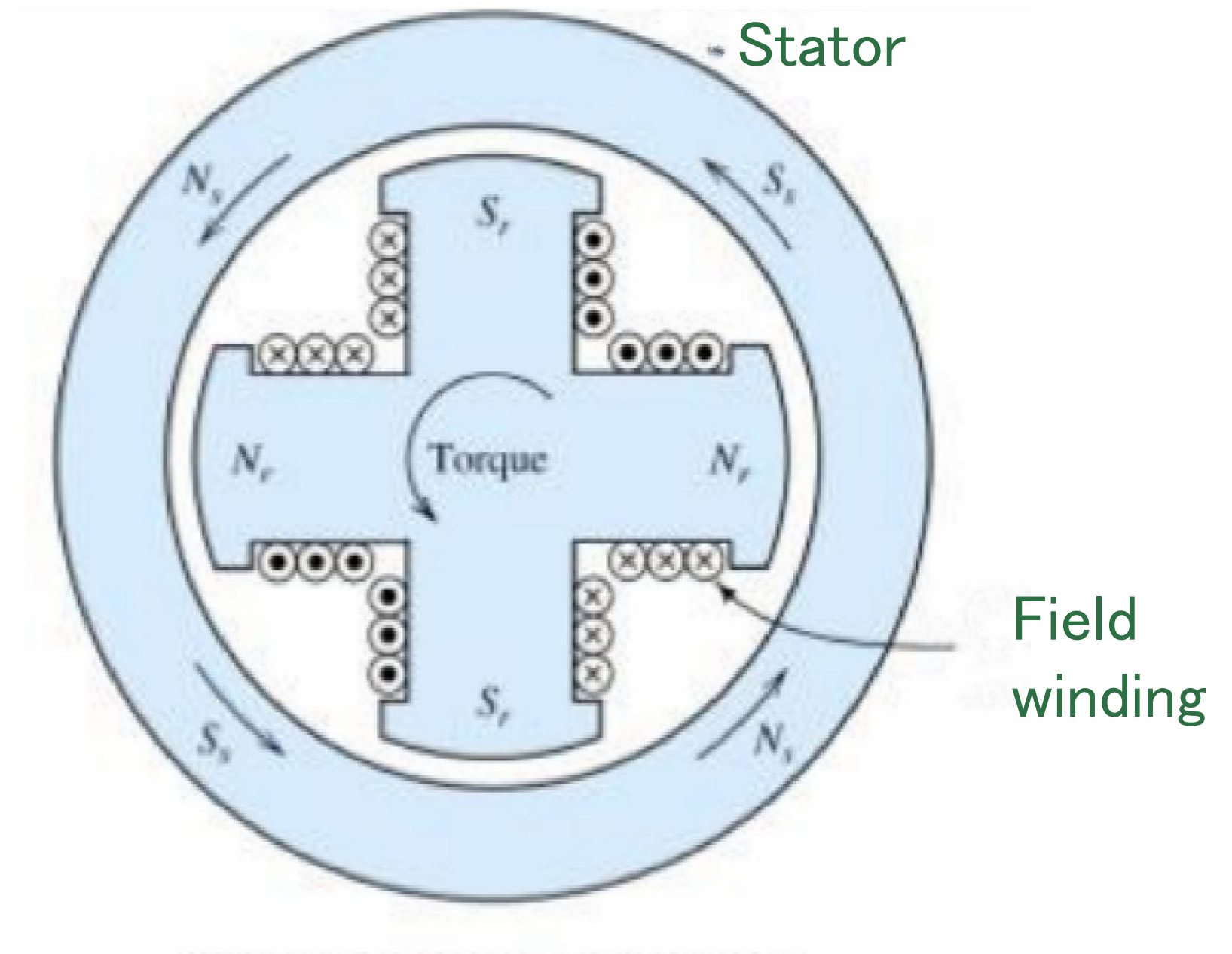

Four-pole salient rotor machine



# DC Machine

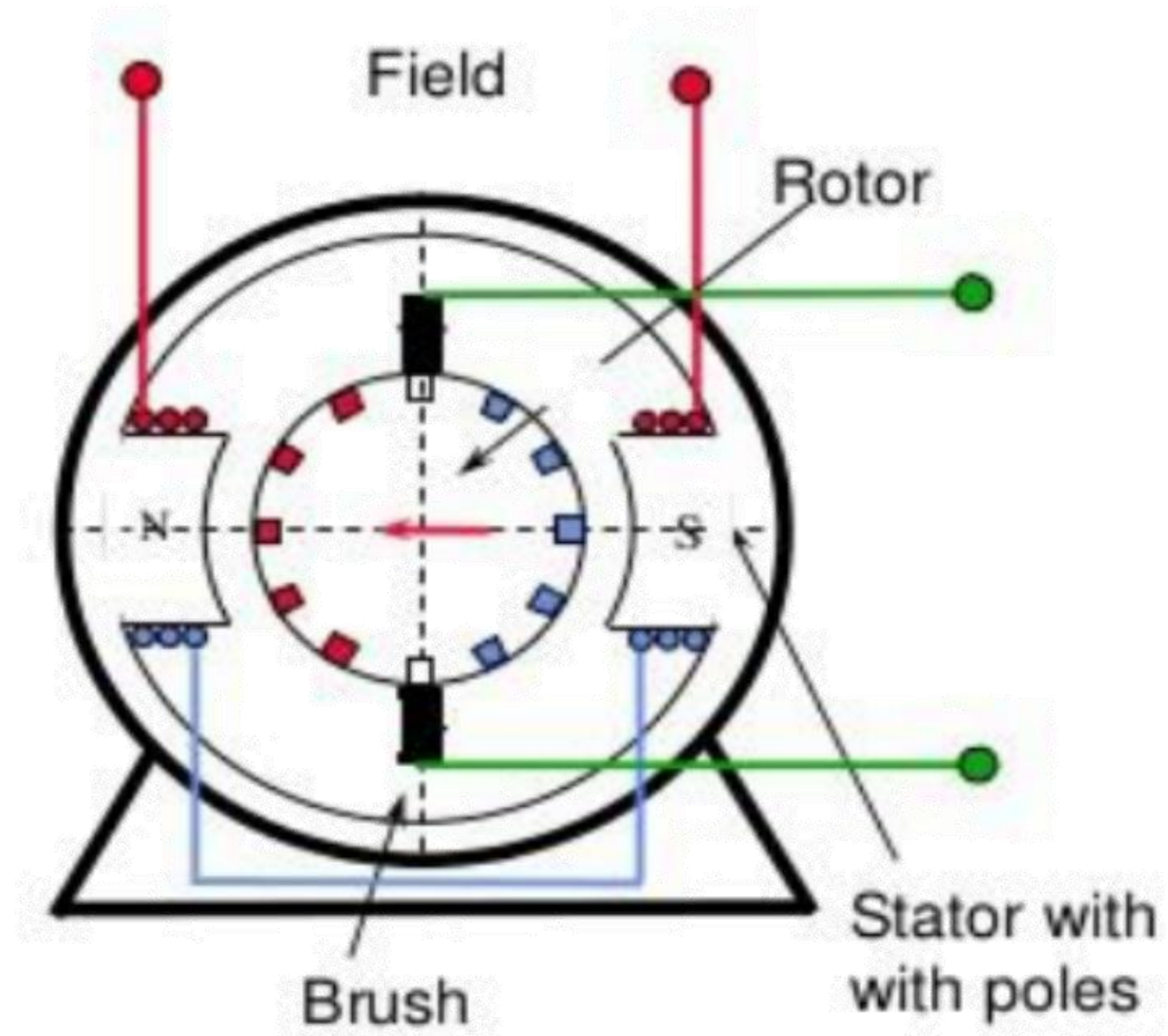

# Measurement Requirement

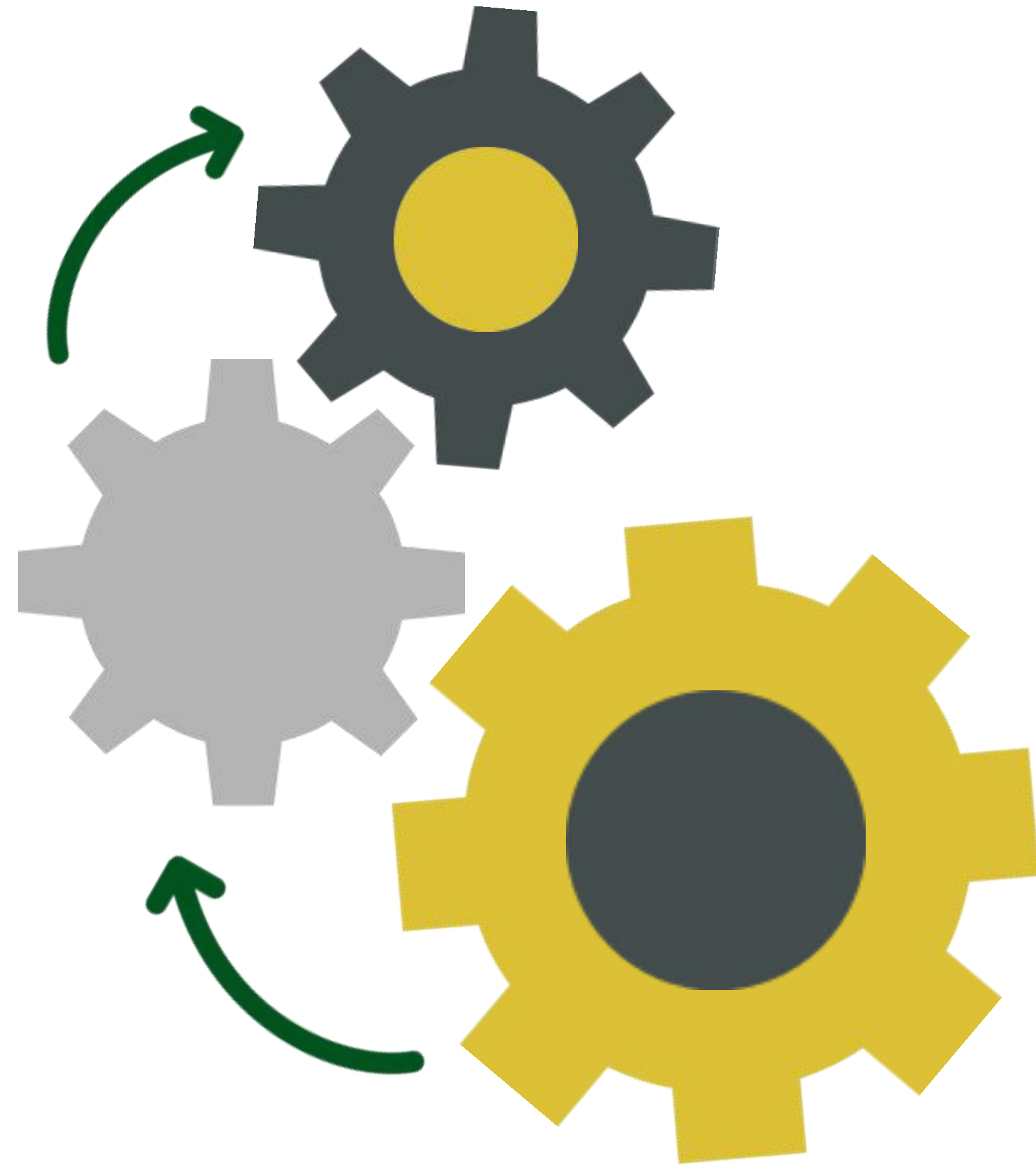

1

Speed and Frequency  
Field Voltage and Current  
Torque and Power

2

Power angle curve  
Voltage Boost  
Voltage per hertz



# Experiments

---

# Experiments

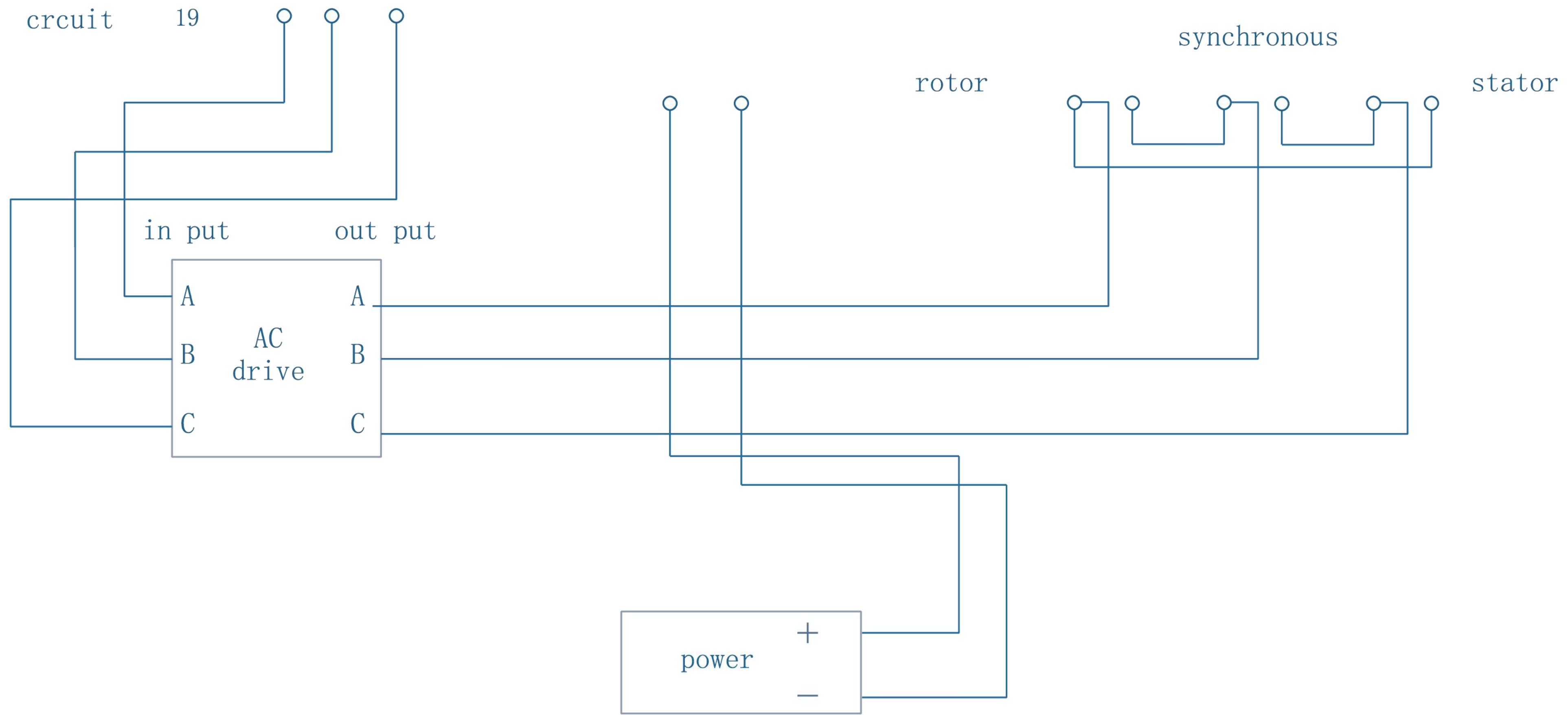

## Synchronous Motor

# Experiments

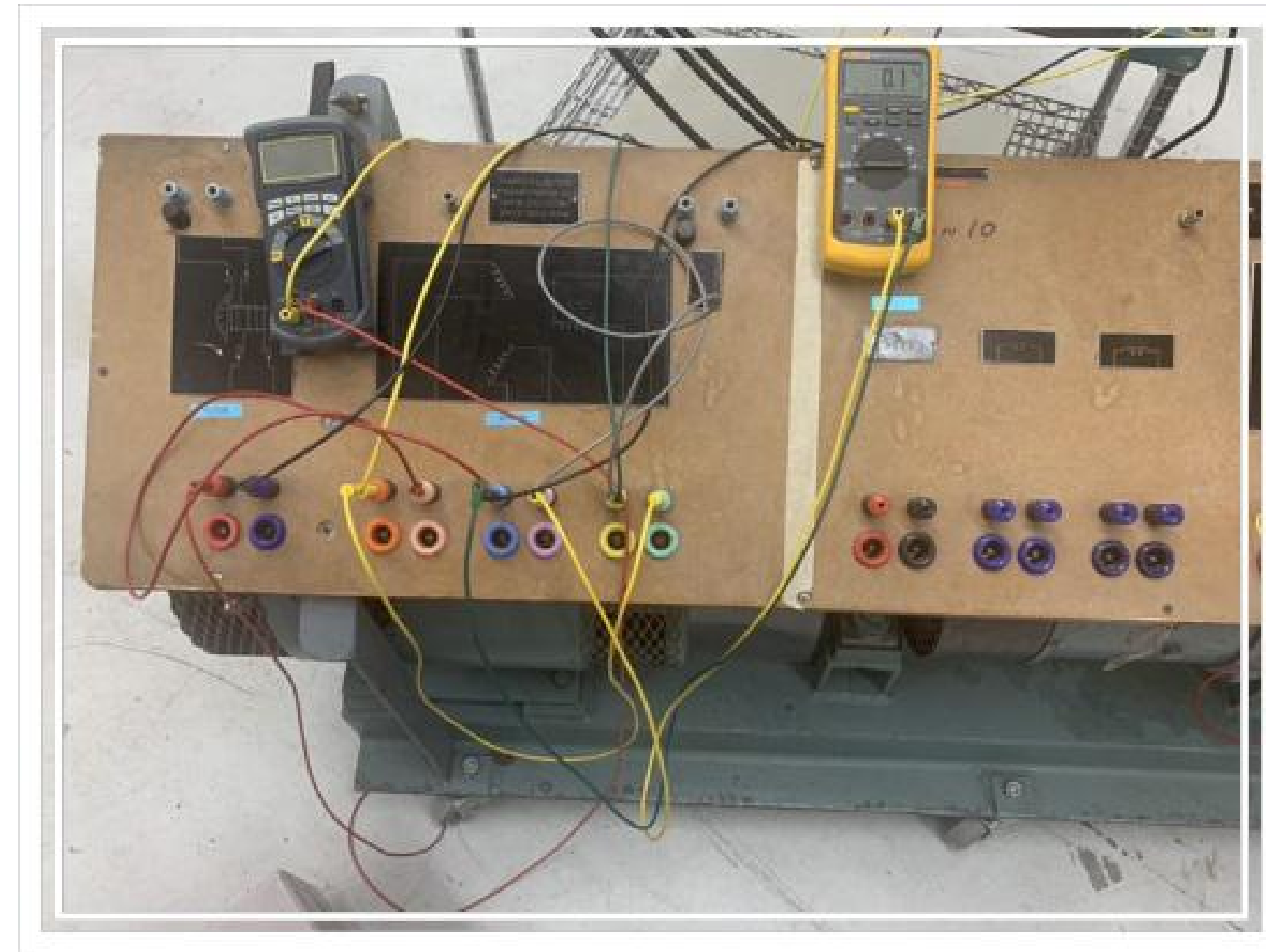

# Data

# Diagram

AC Drive(Hz)	Speed(rpm)
5	139.4
10	296.0
20	603.7
35	1059
60	1822

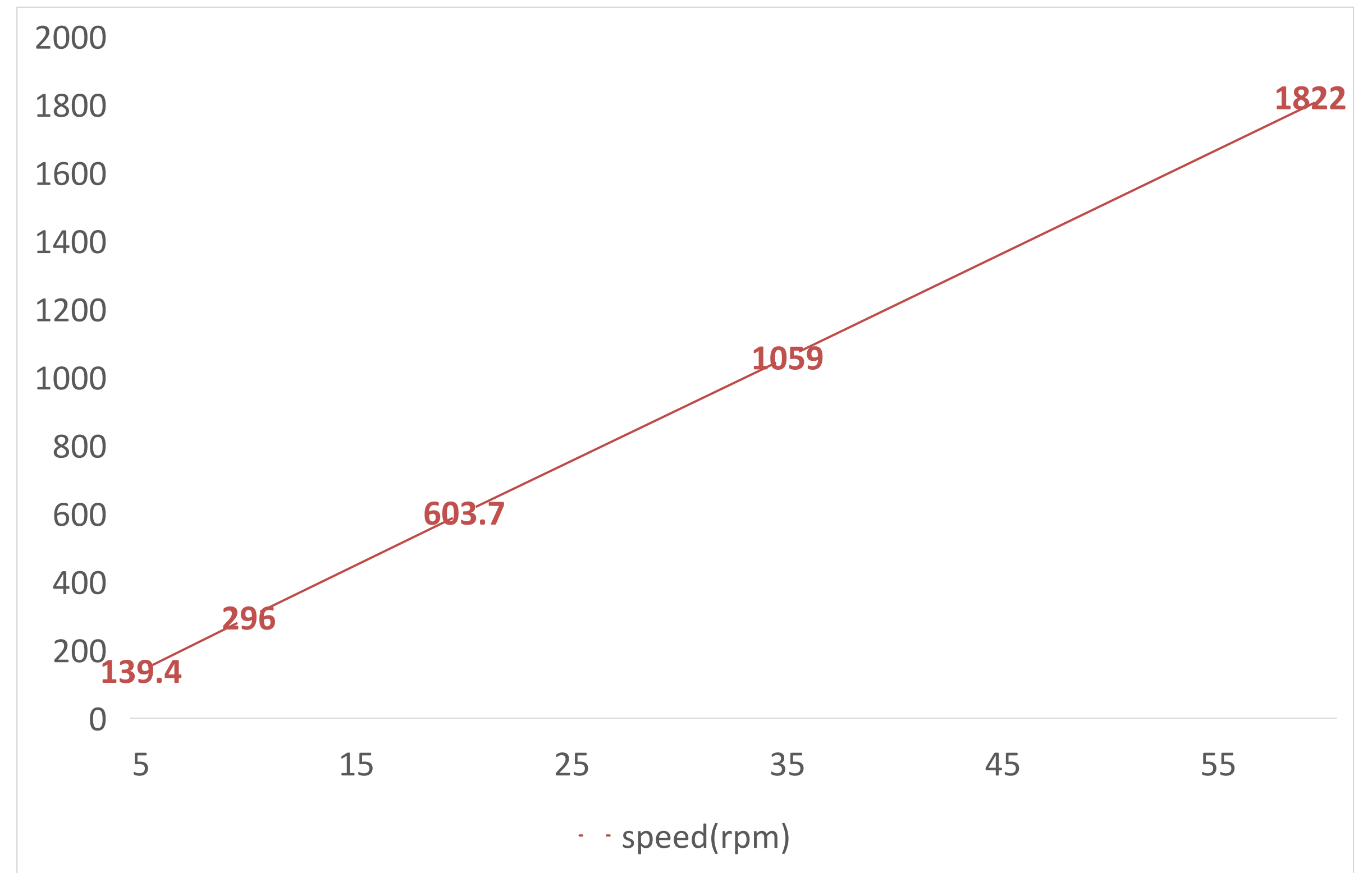

# Synchronous generator

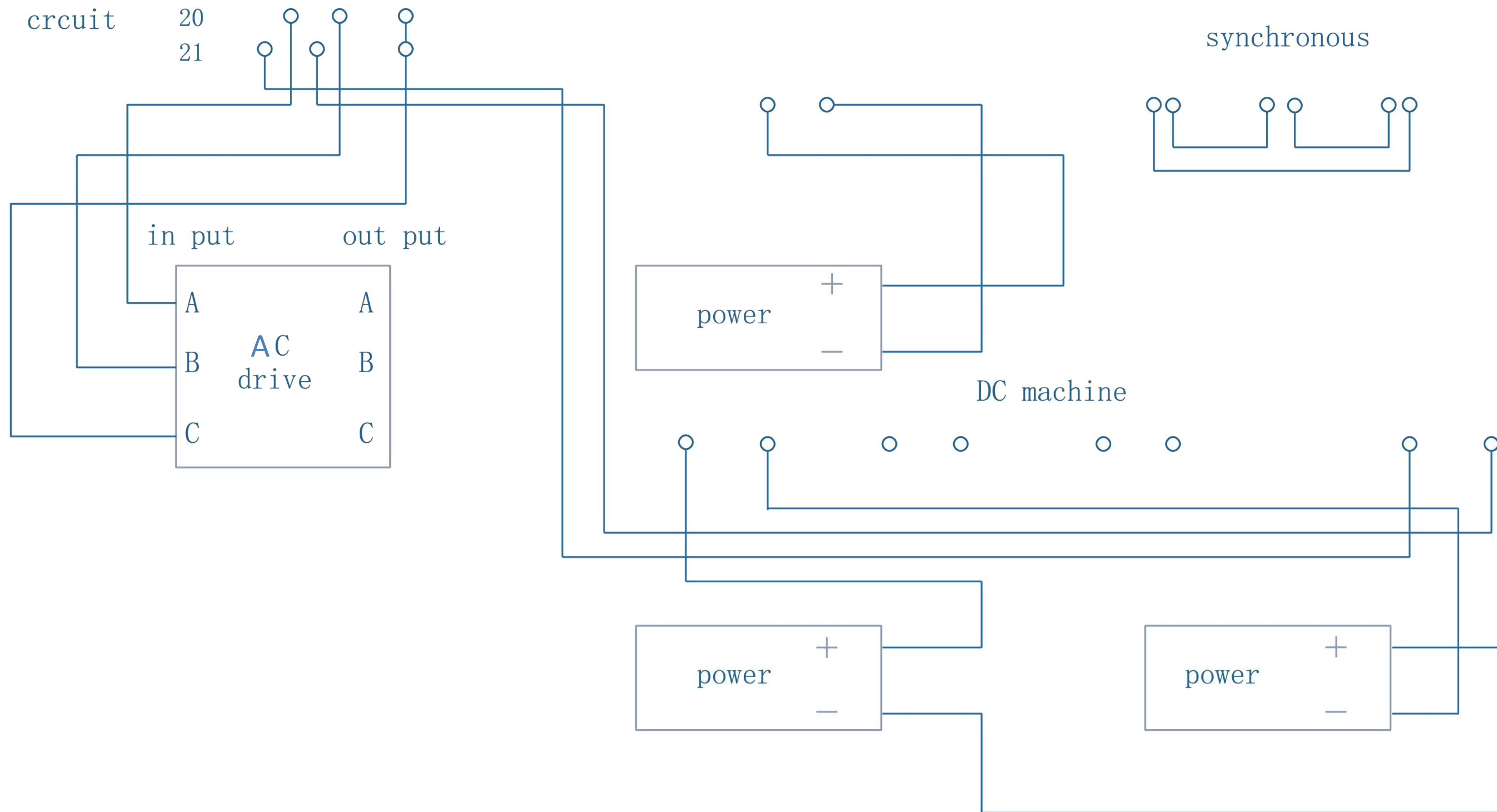

# Experiments

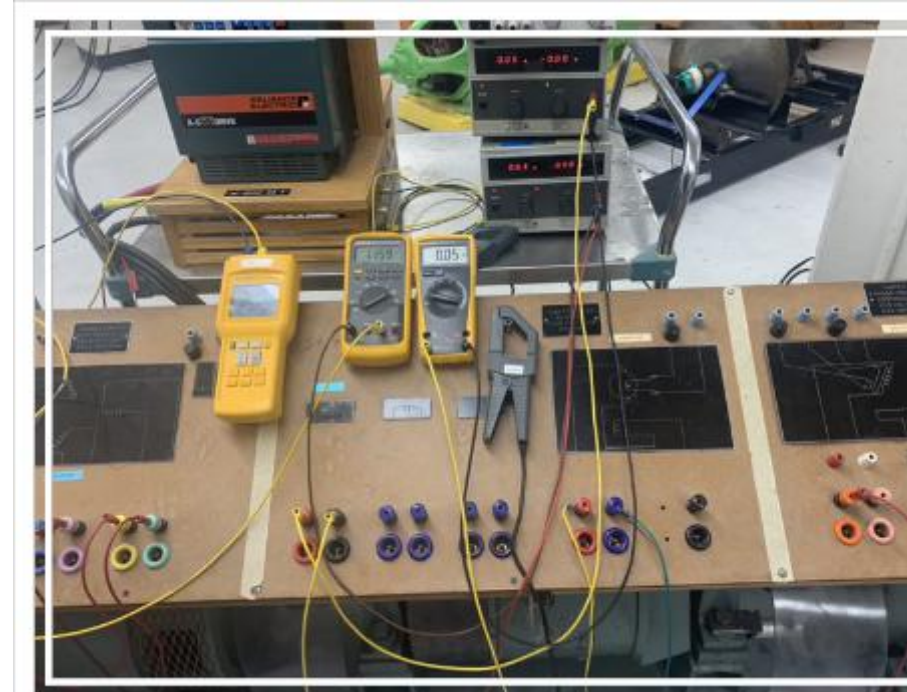
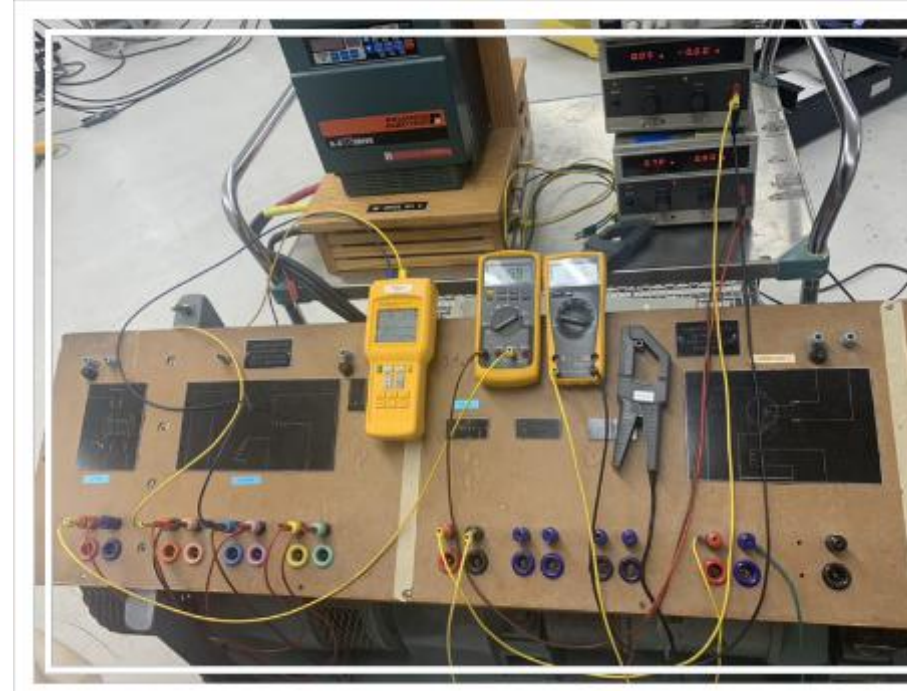
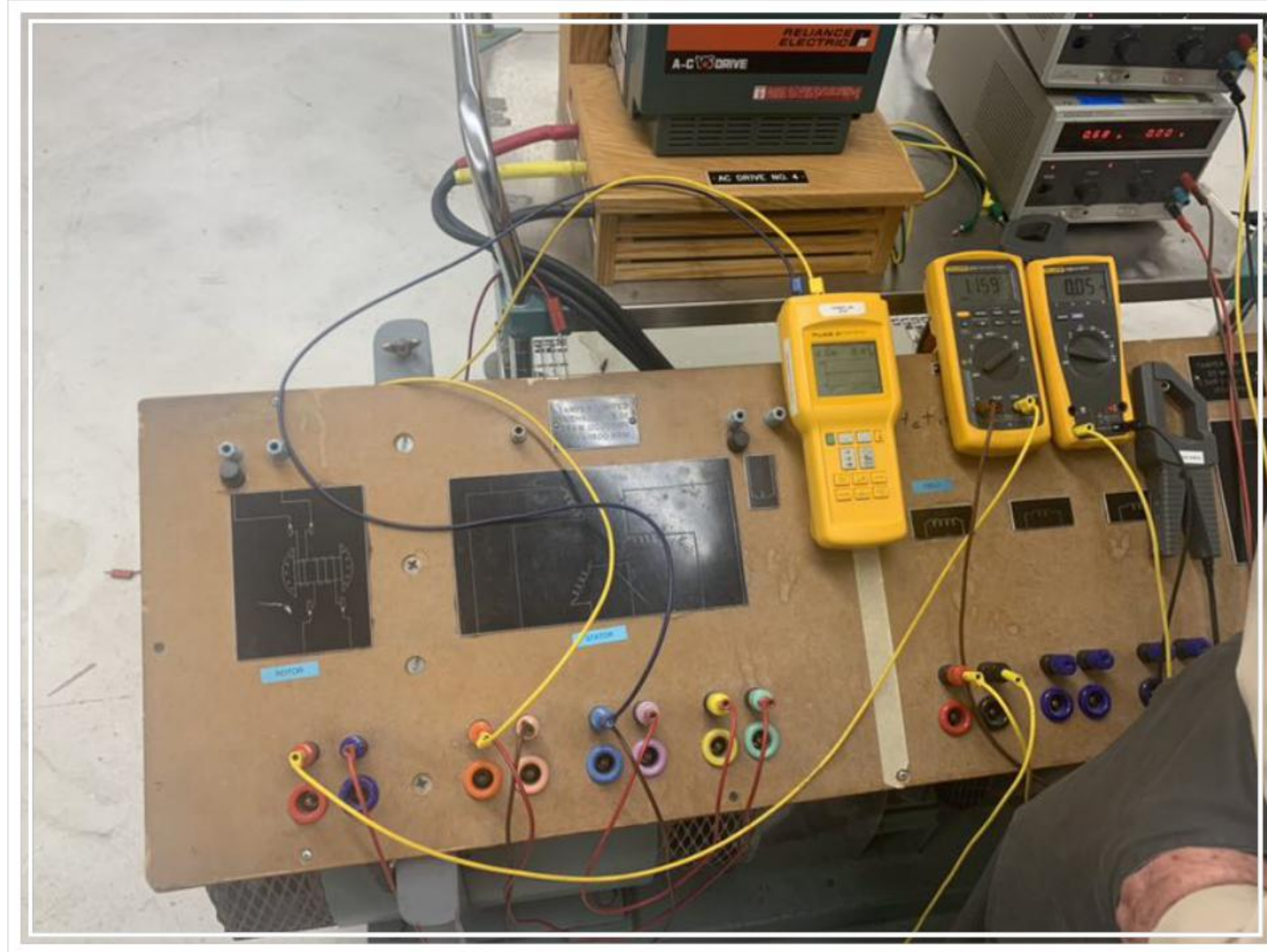



# Data

# Diagram

Field Current(motor)(A)	Voltage(generator)(V)
0.8	13.5
0.73	13.8
0.55	15.3
0.41	17.5

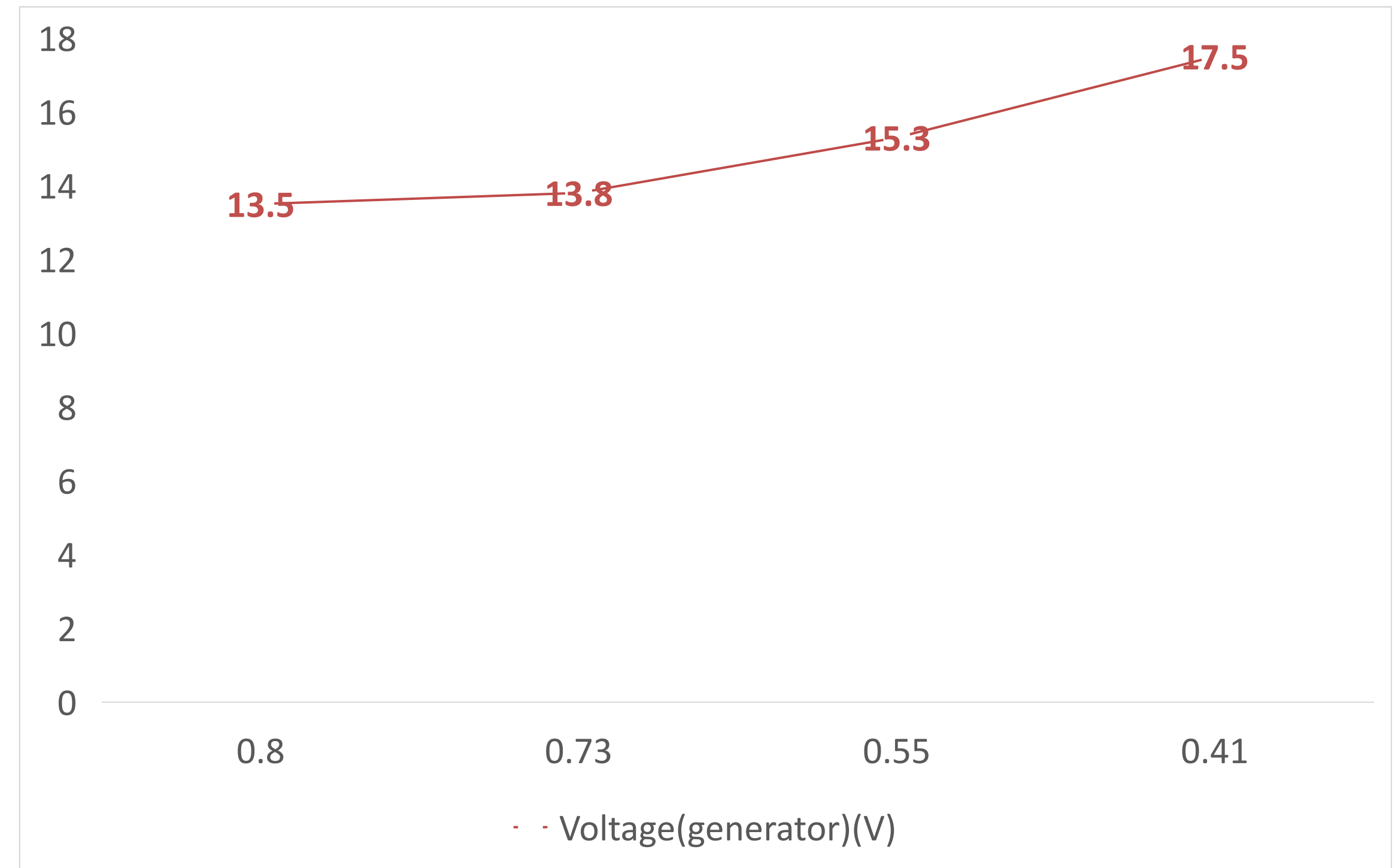

# Data

# Diagram

Field Current(generator)(A)	Voltage(generator)(V)
0.64	13.1
0.9	16.7
1.14	19.0
1.27	19.4
1.38	20.6

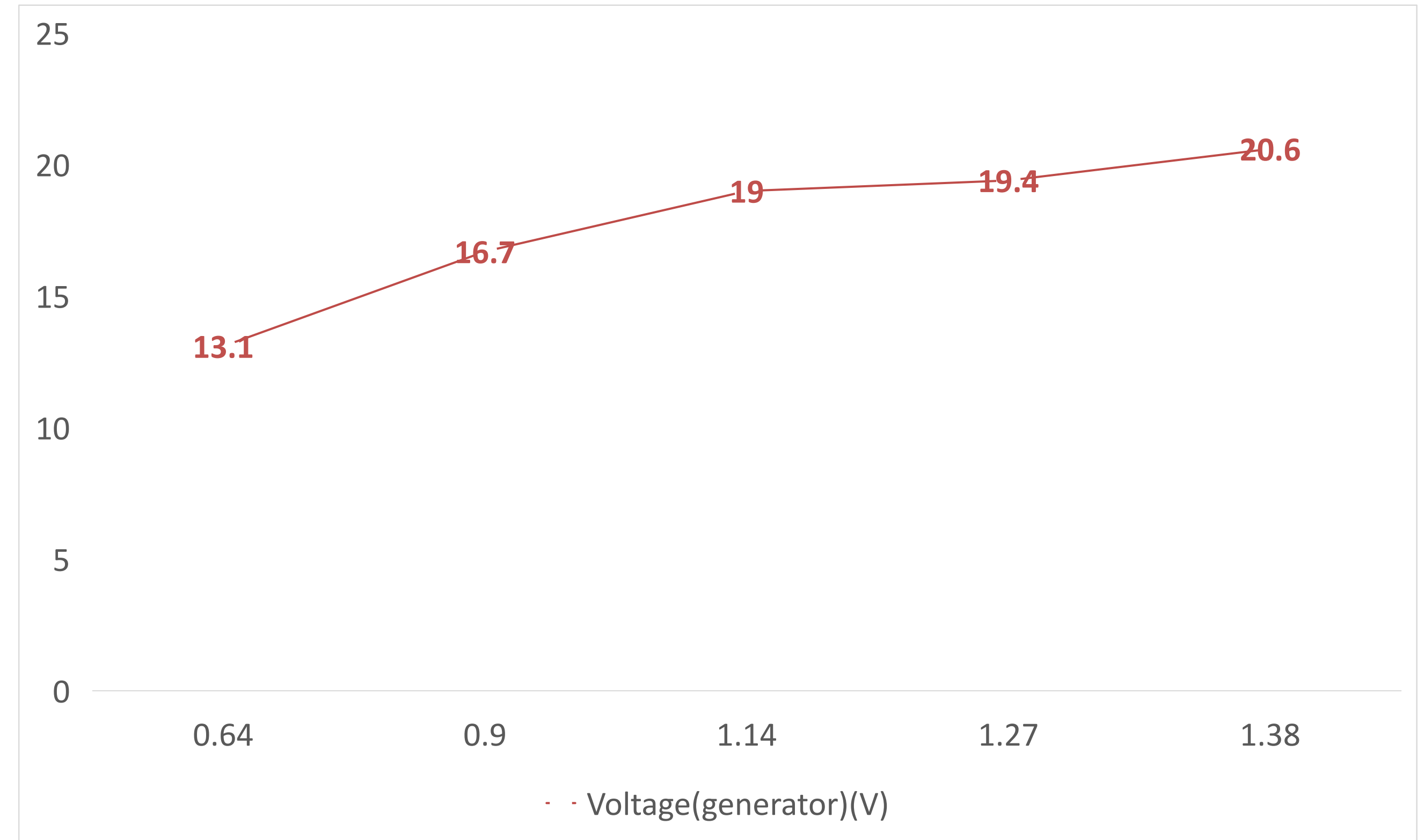

# Data

# Diagram

Field Control(DC volts)(V)	Speed	Frequency	Volts(generator)
30.3	245.2	7.6	19.3
41.0	318.1	10.6	27.1
52.1	417.4	13.9	35.4
59.3	476.7	15.7	40.6
70.5	575.1	19.2	48.8
80.1	657.2	21.9	55.8

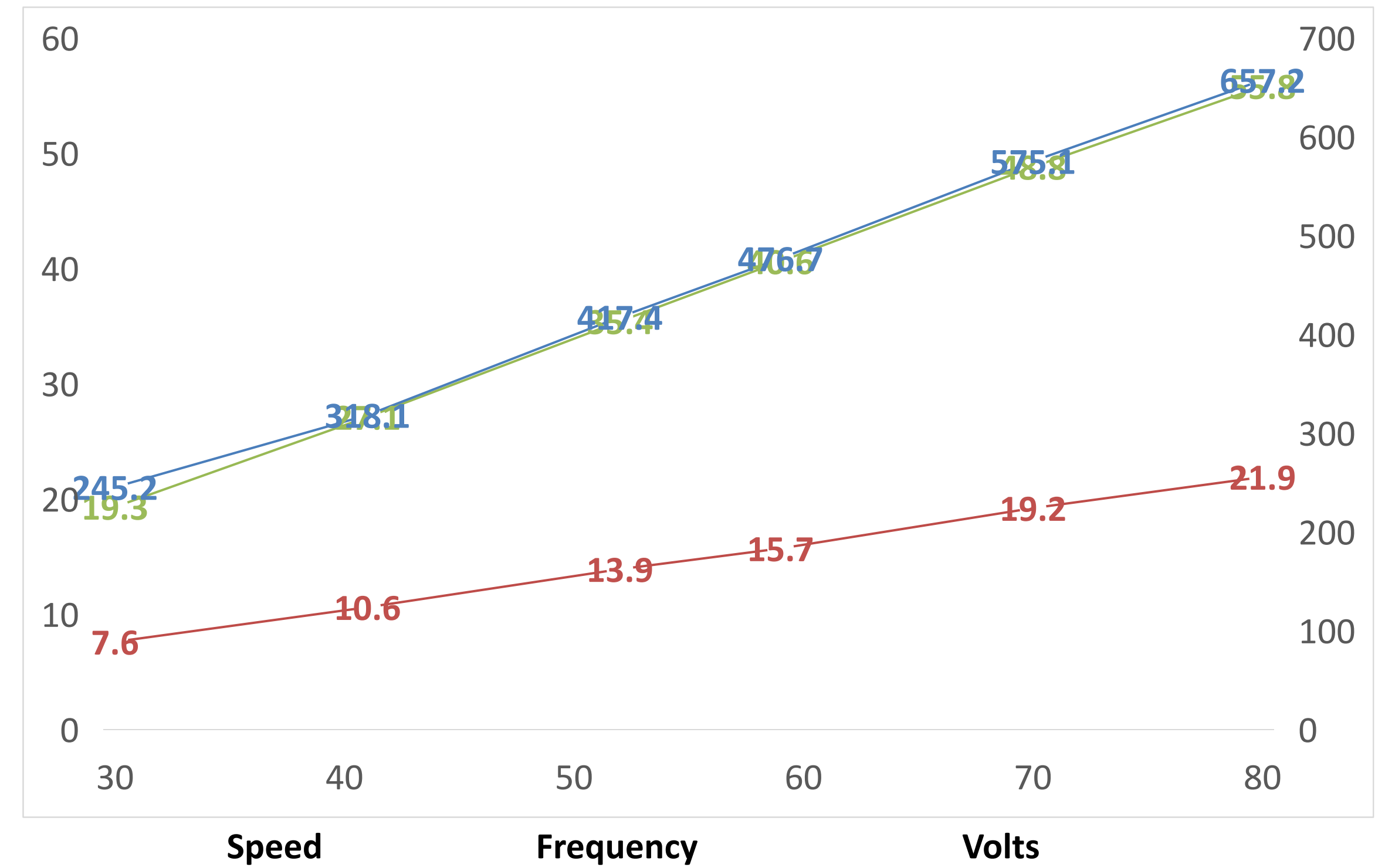

# DFIG and DC machine

DFIG and DC machine

$$W_s - W_r = W_m$$

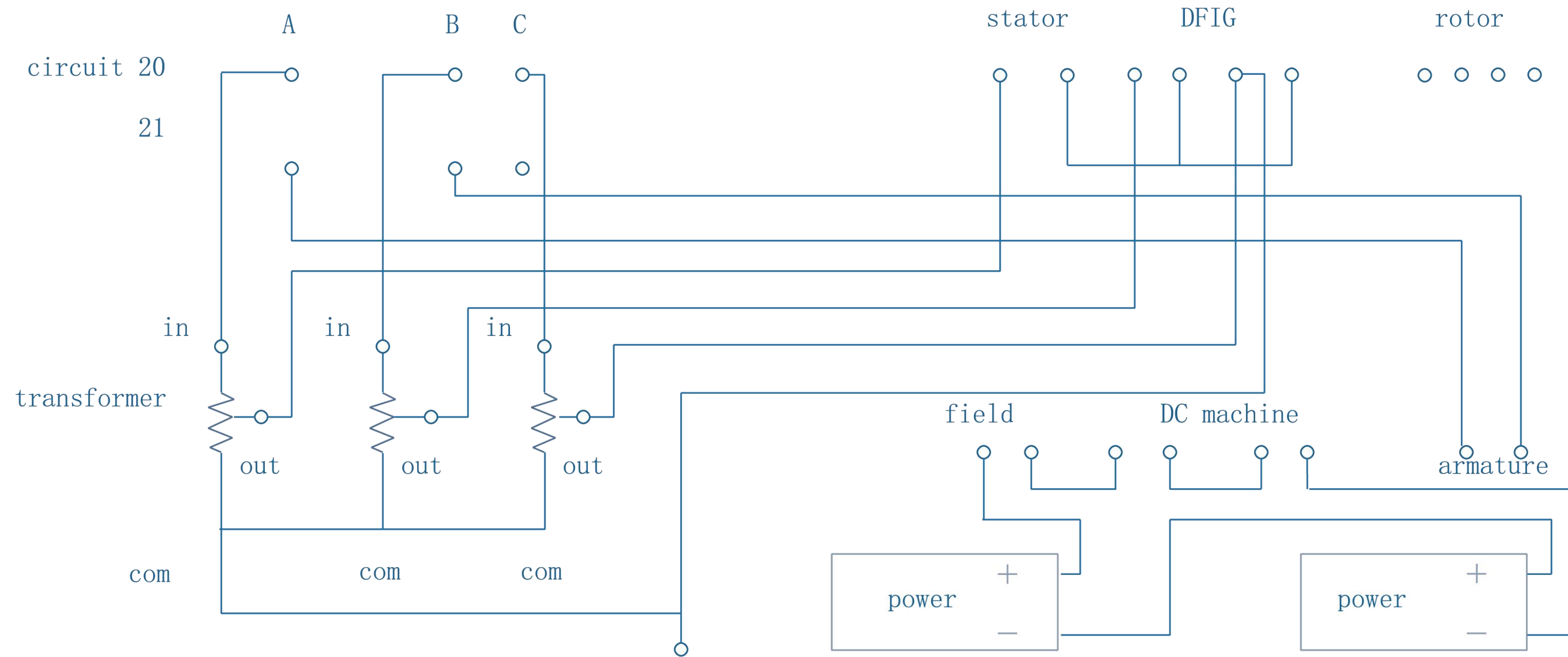

# Data

# Diagram

Field Control(DC volts)(V)	Speed(rpm)	Frequency(rotor)
41	366.8	47.8
53.4	485.8	43.8
64.3	587.5	40.5
73.1	672.8	37.7
93.6	866.6	31.2

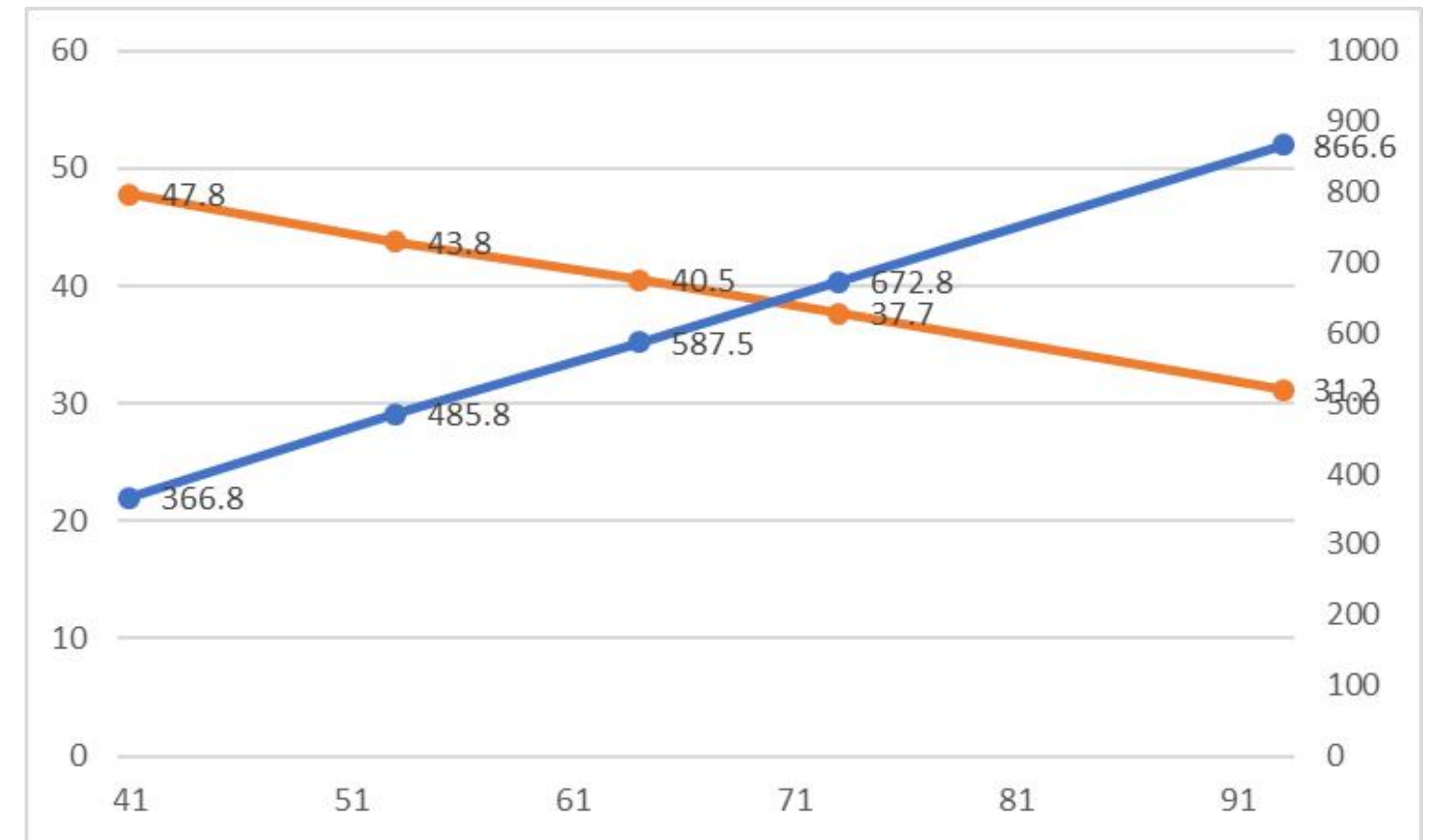

# Data

# Diagram

Field Current(A)	Speed(rpm)	Rotor Frequency(Hz)
0.41	566.2	41.1
0.35	600.7	39.9
0.29	674.8	37.5
0.24	760.5	34.7
0.18	933.4	28.9

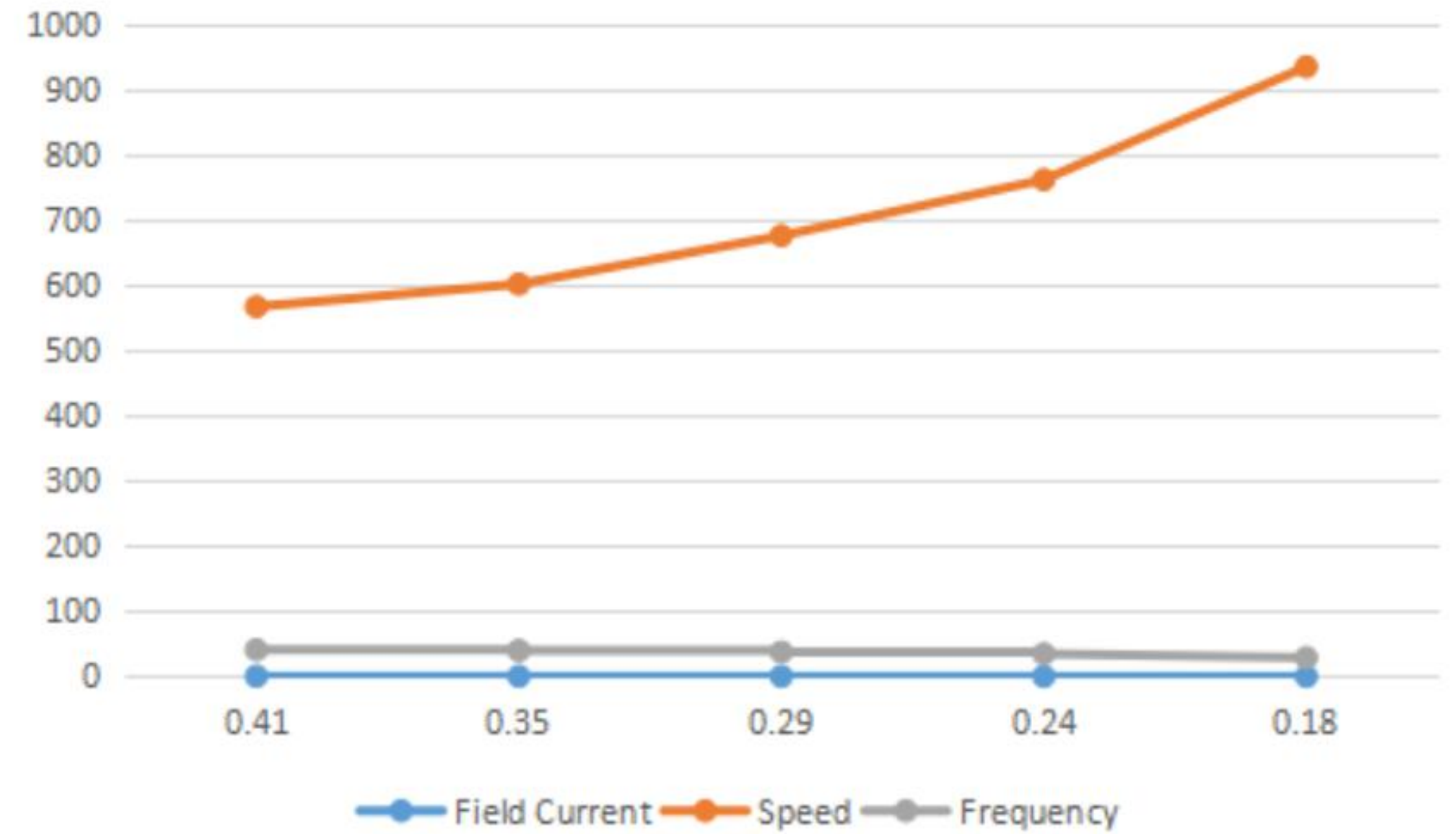

# Data

# Diagram

Field Current	Speed	Frequency
0.32	249.1	68.3
0.27	289.7	69.7
0.19	370.3	72.4
0.11	481.7	76.1
0.04	559.2	78.7

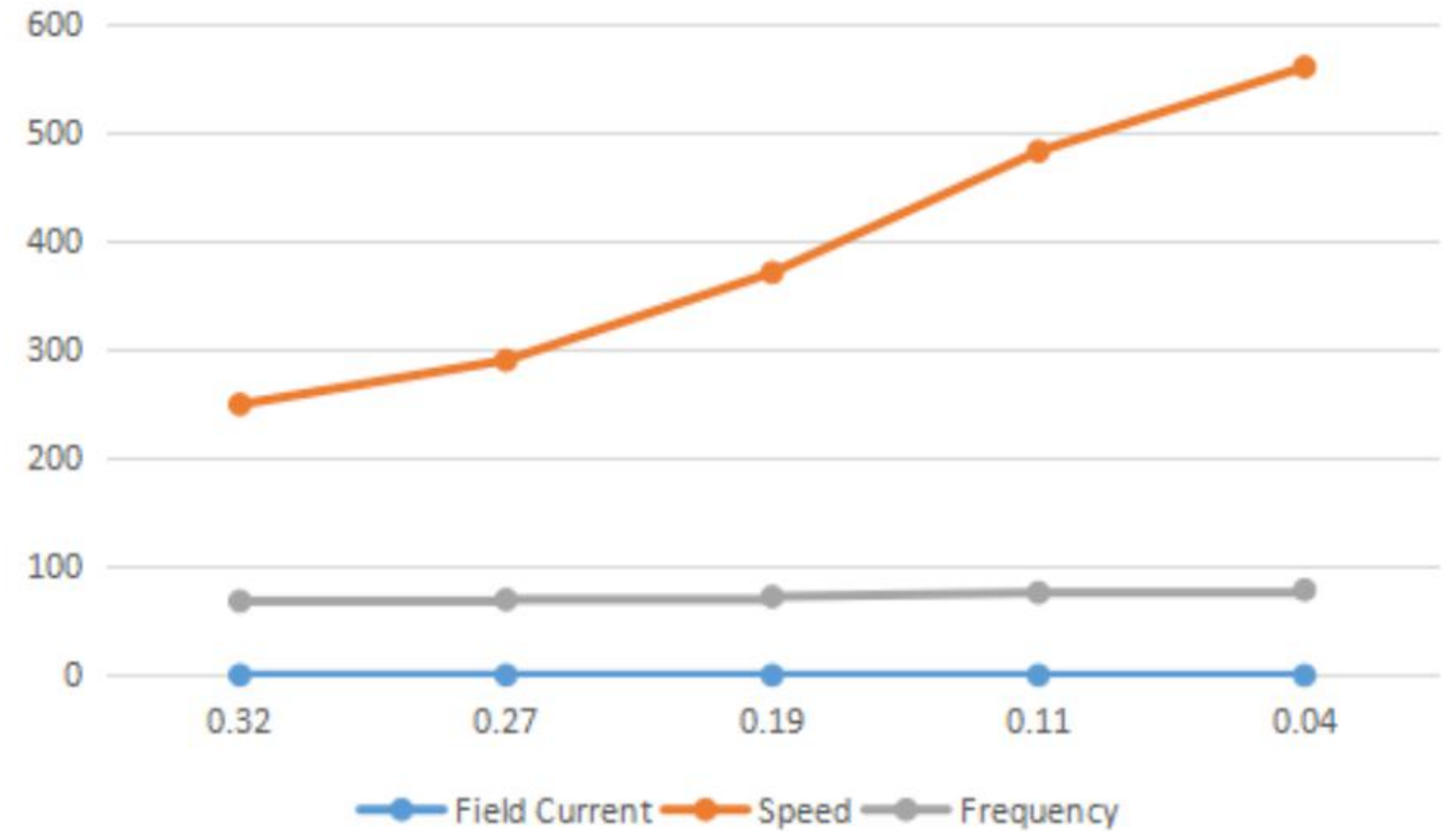

# Data

# Diagram

Field Control	Frequency	Speed
27.8	68.7	260.4
37.9	72.2	365.2
47.7	75.6	467.5
56.8	78.7	560.2
69.8	83.3	696.5
83.6	88.2	846.3

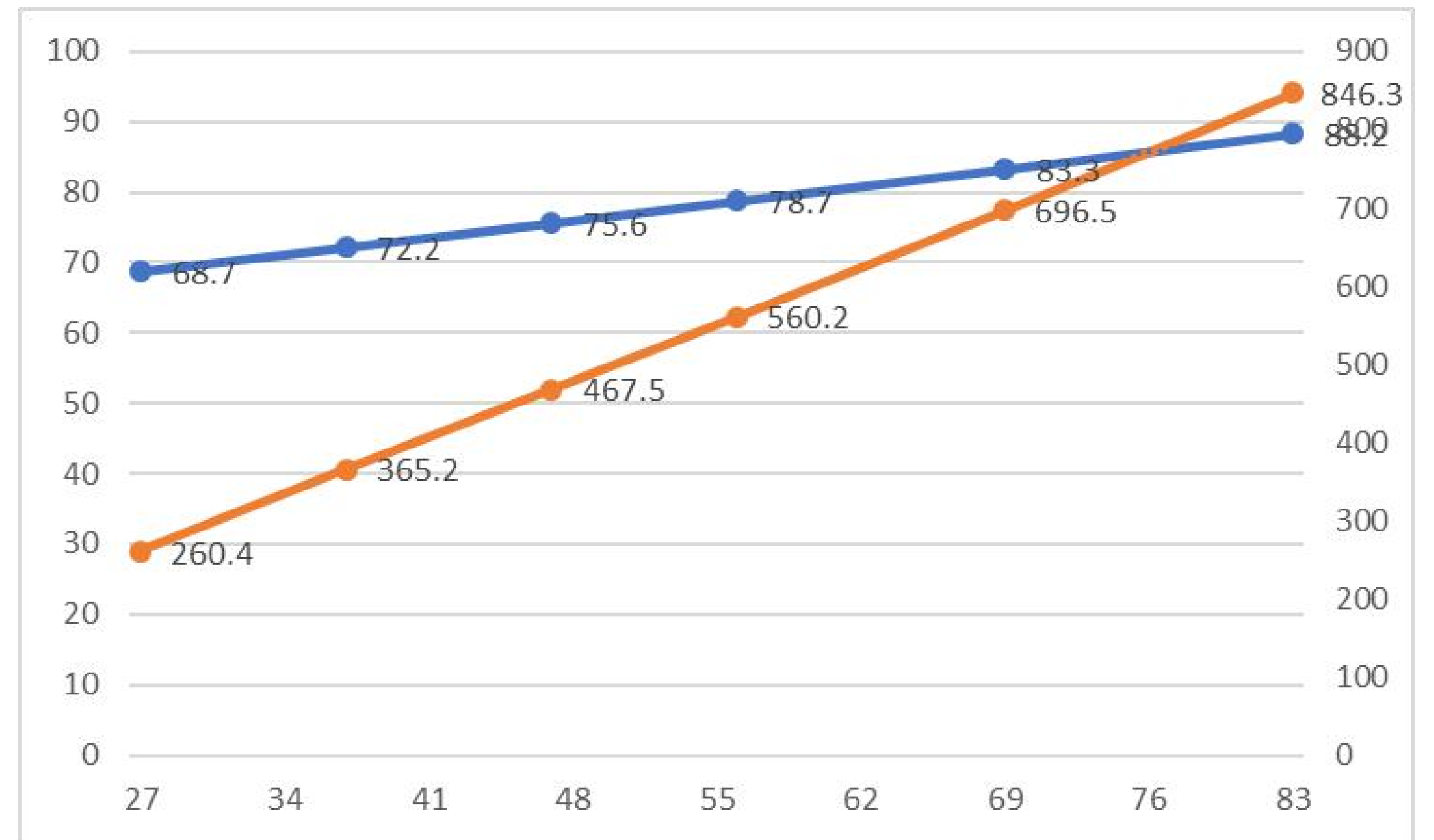



# synchronous motor and DFIG

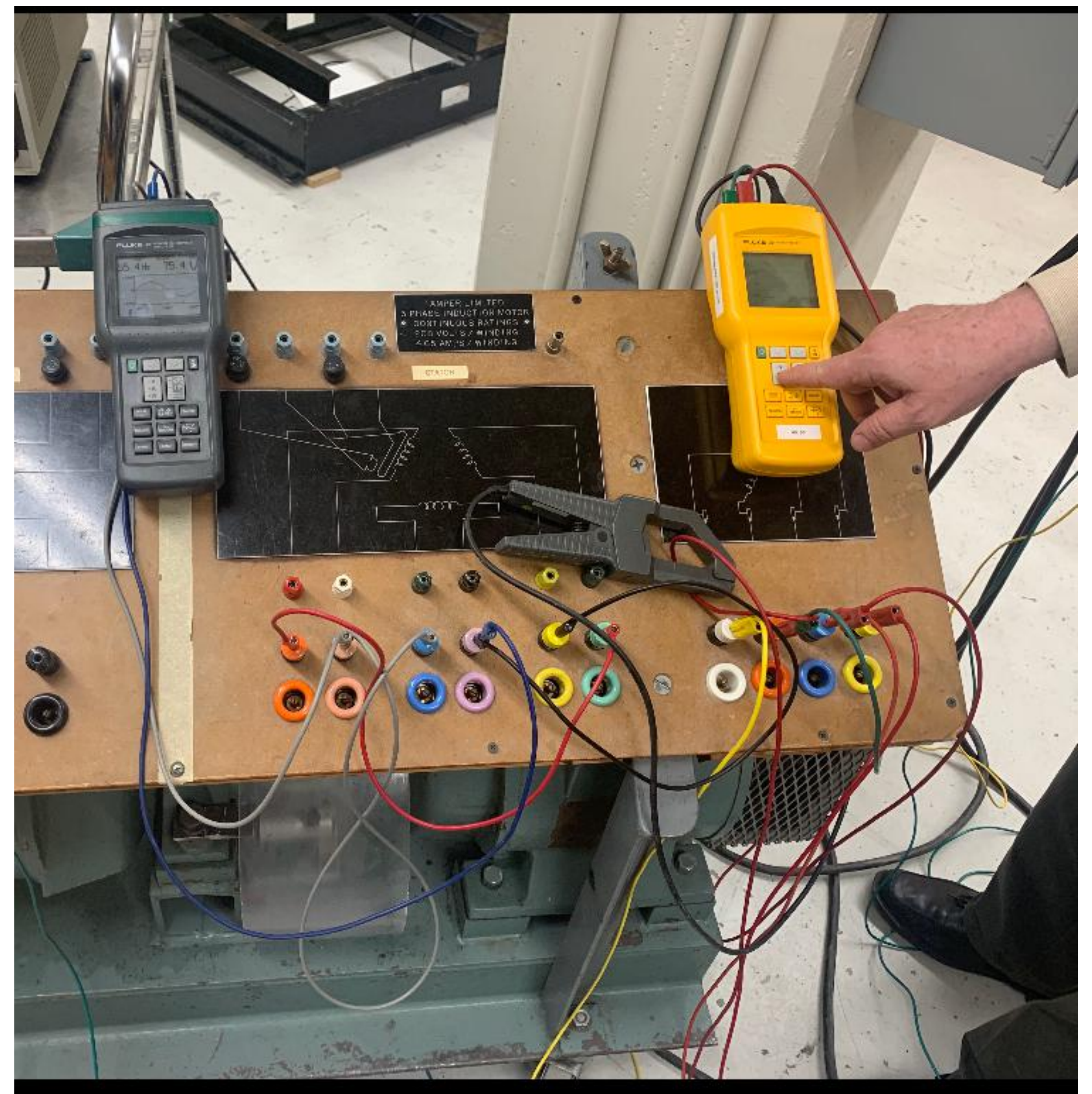
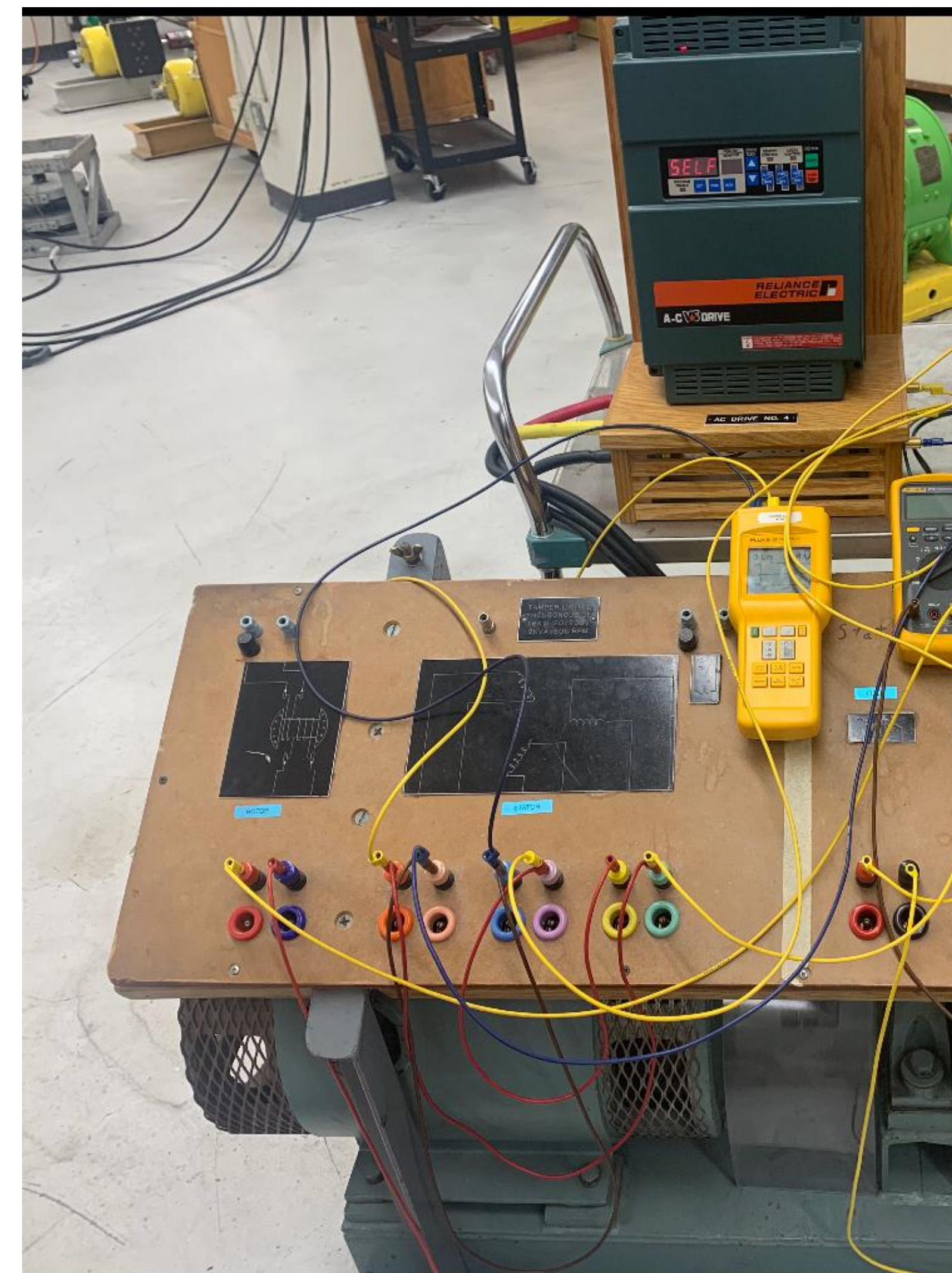

# Connection

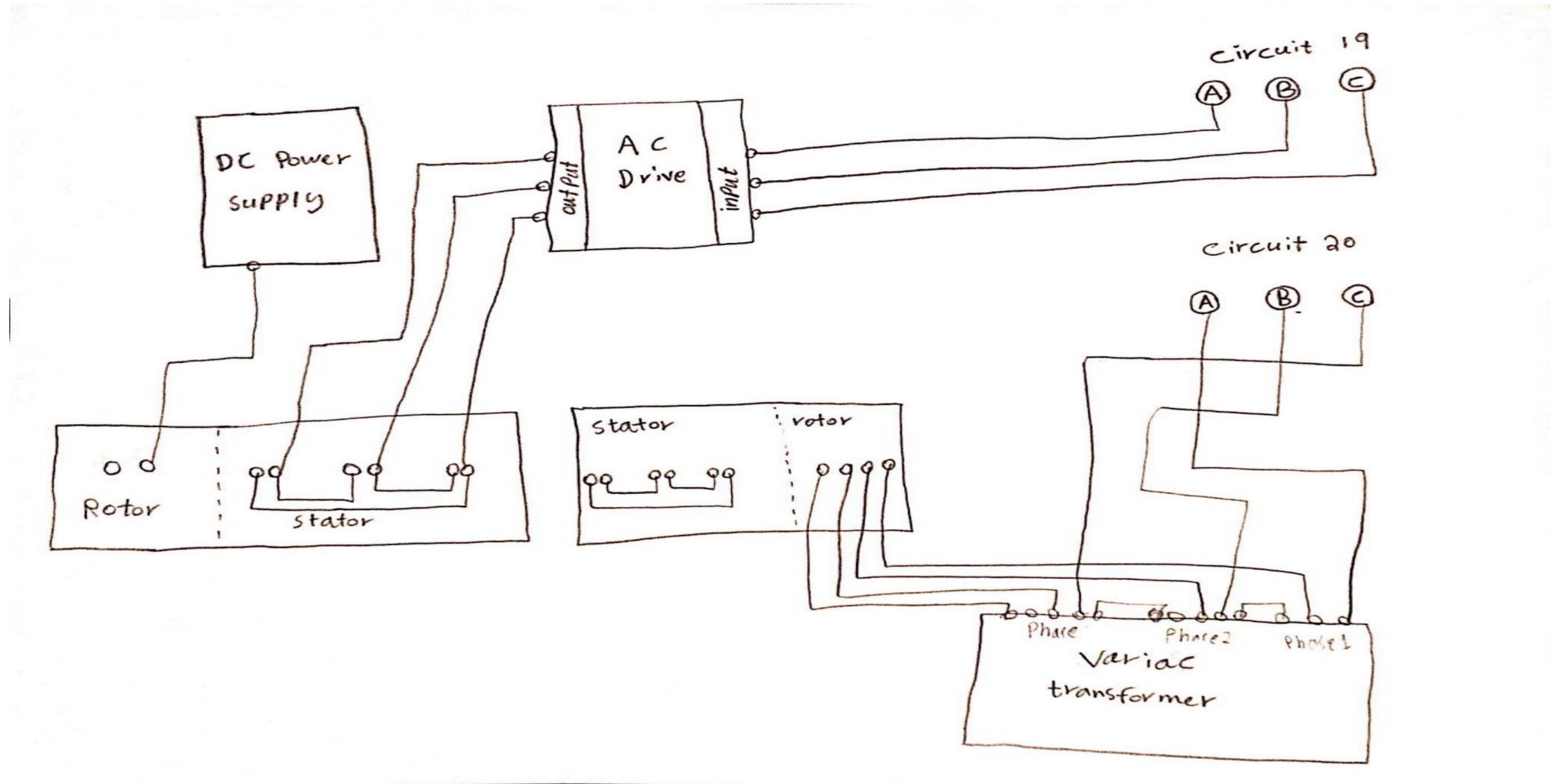

# Data

## Synchronous motor

voltage	speed	Frequency
33.8	137.4	5
47	297	10
77	448.9	15
97	608.3	20
103	755.2	25
240	1822	60

## Double fed induction generator

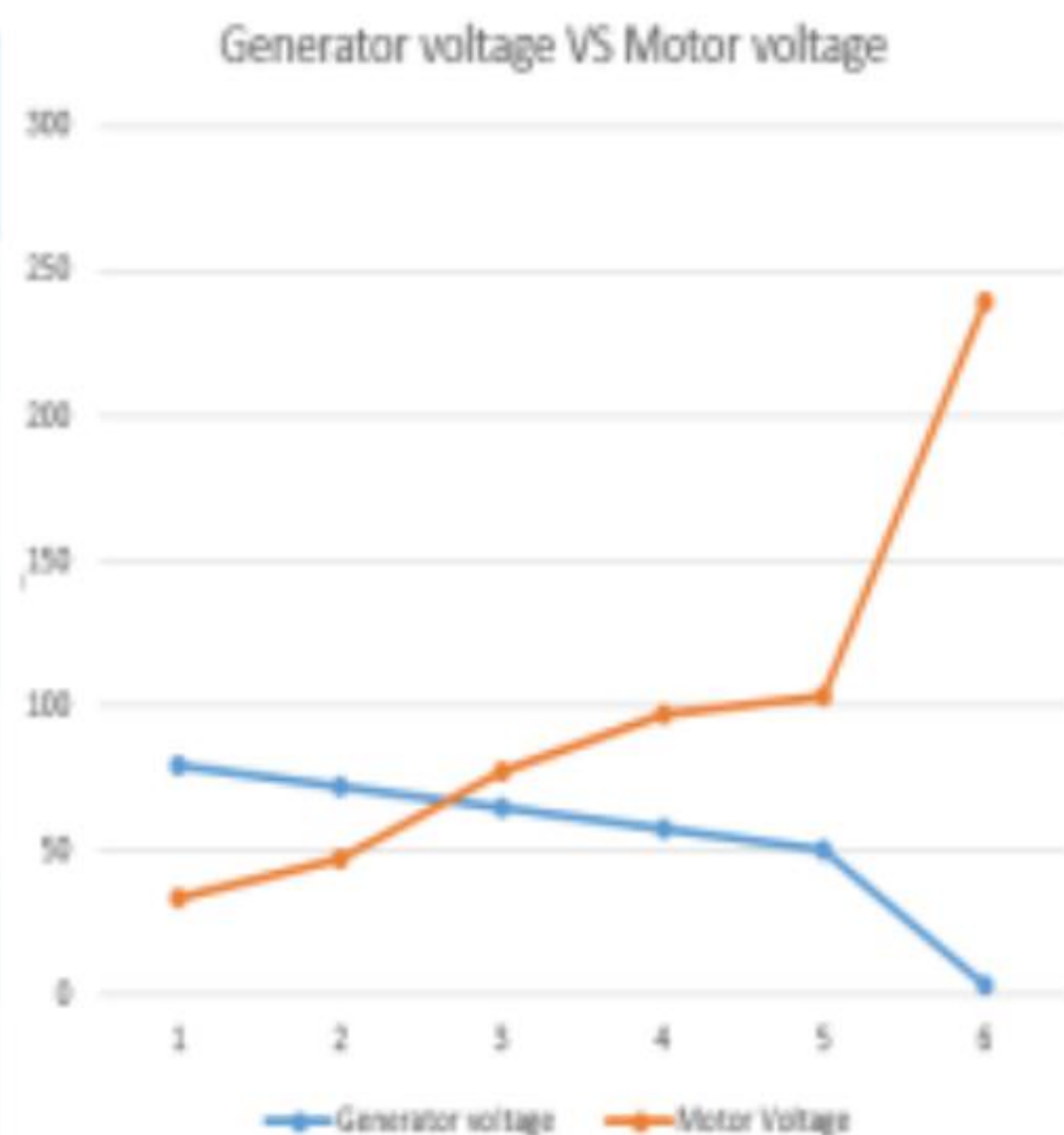

voltage	Frequency
79.7	55
72.1	50
64.6	45
57.2	40
50.1	35
3.3	0

Frequency on the AC drive (Hz)	motor voltage (V)
5	33.8
10	47
15	77
20	97
25	103
60	240

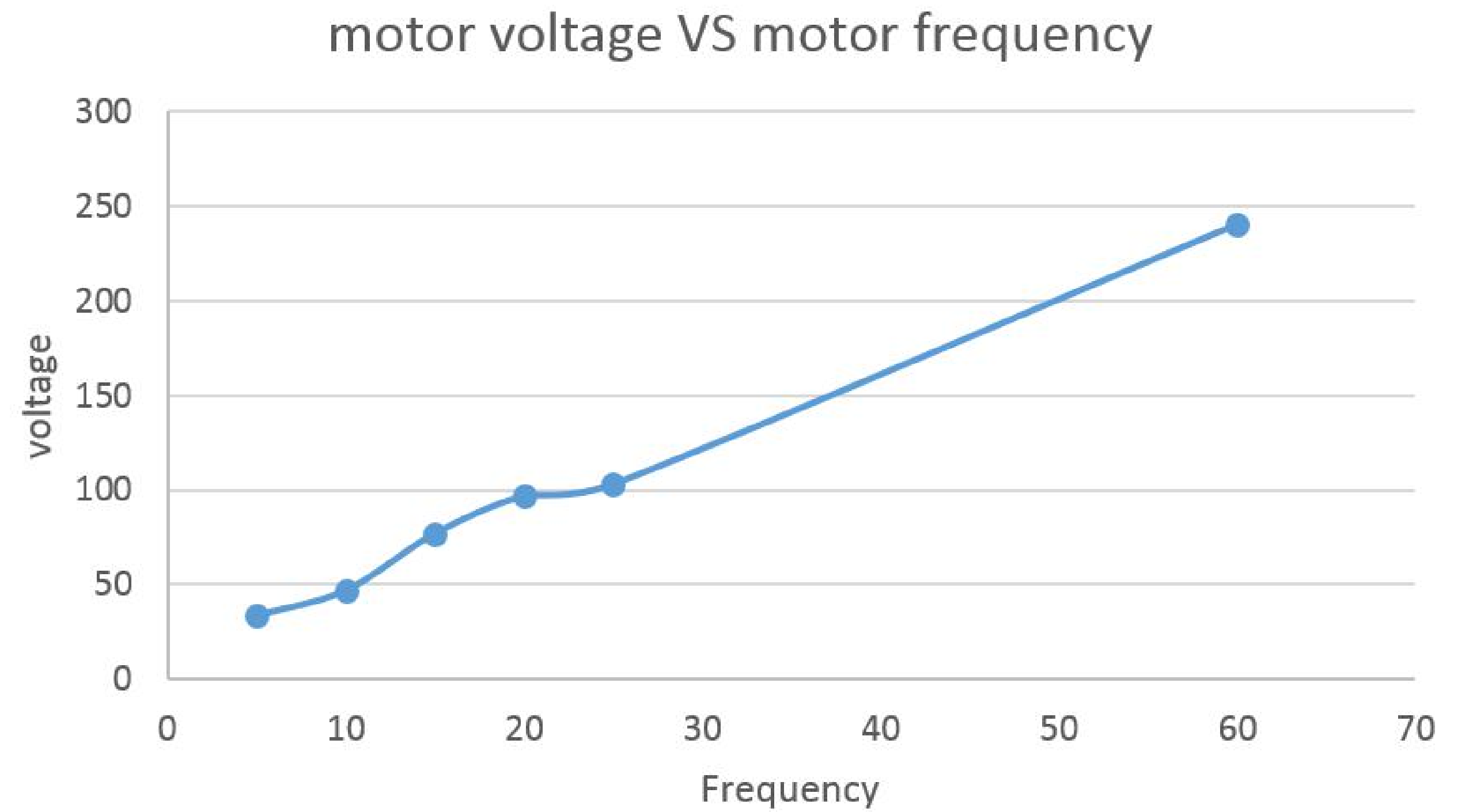

Frequency on the AC drive	speed
5	137.4
10	297
15	448.9
20	608.3
25	755.2
60	1822

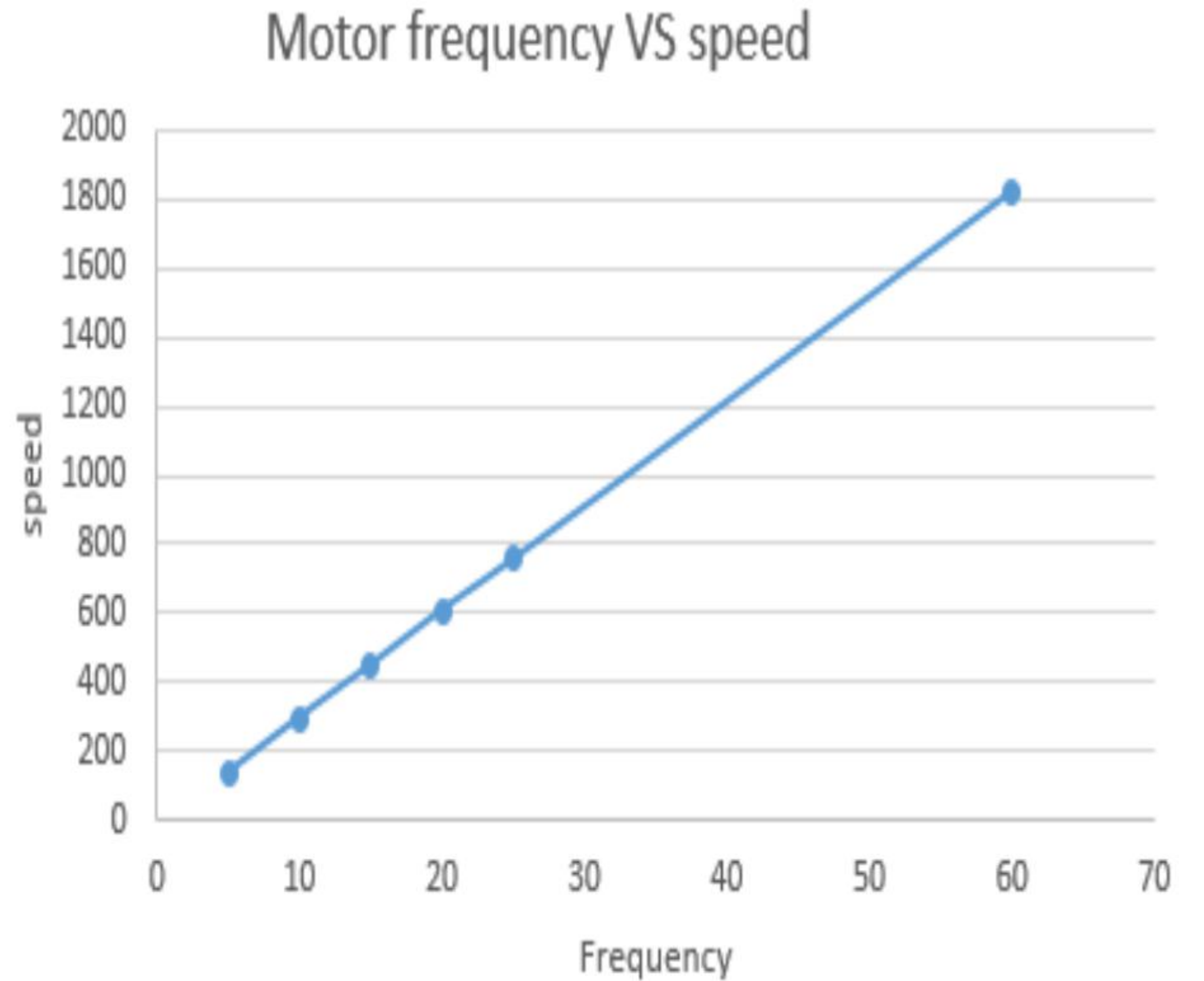

Frequency on the DFIG	Generator Voltage
55	79.7
50	72.1
45	64.6
40	57.2
35	50.1
0	3.3

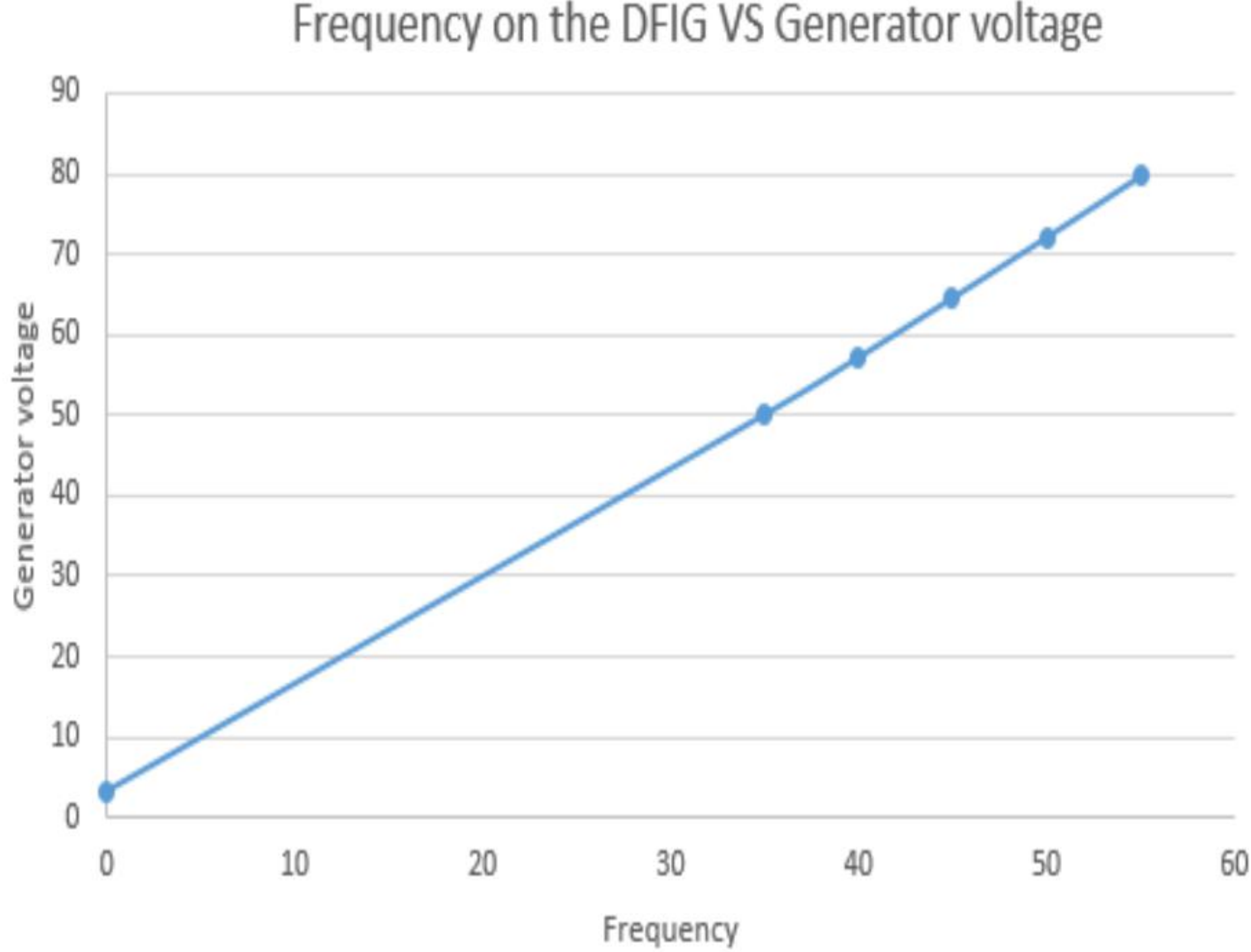



# Budget

Since our senior design project is to come up with some lab experiments, all the required equipment is provided in the lab already. Therefore, our expectation is to spend nothing.



Thank you for watching!

---

---