

2013

Formula Electric Vehicle Battery and
Battery Management System

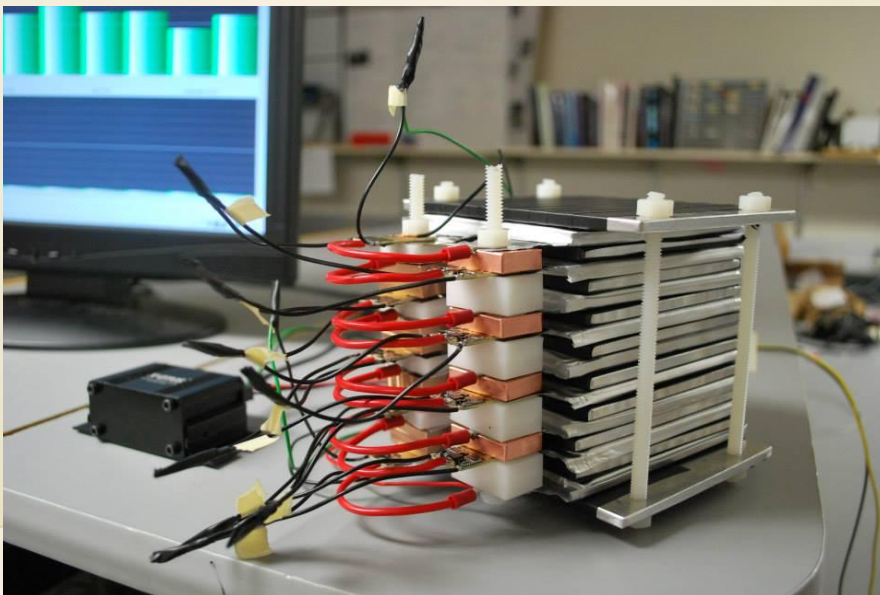

Advisor: Dr. Herbert Hass

Team Member: Antonio Telleria, Blazen Ingram, Chihan Wang

12/13/2013



Vandal Formula Electric Vehicle Team
Formula Electric Vehicle Battery and Battery Management System

Acknowledge

Comment [p1]: Please work on this part

Our team owes many thanks to many people for supporting and encouraging us through this process. To our advisor, Dr. Hass.....

Mentor: Jaz Veach

Gillette Zenner

Gauss-Johnson

Greg Klemesrud,

John Jacksha,

Robert Fuhrmann,

Rory Lilley

I put all the people who help us on this project. You guys can work on this page see what you want to said.



Table of Contents

Acknowledge 1

Executive Summary 4

Background 5

Problem Definition 6

 Goals 6

 Deliverables 6

 Specifications 6

 Constraints 6

Project Plan 7

 Items Completed 7

 Items to Complete 7

Concepts Considered 8

 Estimation of Parameters 8

 1. Flywheel 9

 2. Ultracapacitors 10

 3. Lithium-ion cells 10

Concept Selection 11

 Energy Storage Method 11

 Battery Management System 11

 Charger 11

System Architecture 12

 General Powertrain Architecture 12

 Completed Work 13

 1. Components 13

 2. Models 14

 3. Hybrid Vehicle Battery System 15

 Component Selections 15

 1. Batteries 15

 2. Battery Management System 16



Vandal Formula Electric Vehicle Team
Formula Electric Vehicle Battery and Battery Management System

Test Procedures & Results:.....	17
Testing Platform.....	17
1. Discharge Characteristics.....	18
Heat Transfer Model.....	18
System Assembly.....	20
General Plan.....	20
Block Plan.....	23
Future Work.....	26
Full System Construction.....	26
Integration of Safety Electronics.....	26
Containment Vessel Design & Construction.....	27
Appendix A: Battery Manufacturer Spec Sheet.....	28
Appendix B: Battery Management System Manufacturer Spec Sheet.....	29



Executive Summary

The goal of this project is to design a LiPo-based battery system with regenerative capabilities for powering a formula electric vehicle. The system must balance power density with energy density: it must be able to output up to 85kW of energy to quickly accelerate the vehicle, but must also store enough energy to power the vehicle at moderate speeds for at least 30 minutes. The system will also interface with a prototype regenerator that will return kinetic energy reclaimed during braking to the batteries. All of these capabilities must be provided in as lightweight a package as possible so that the finished vehicle can maintain a high power-to-weight ratio.

The proposed system will consist of 81 Lithium polymer batteries arranged in series and capable of providing up to 80kW of power to the onboard motors at 300V, while also accepting burst charging currents of up to 30A. The Lithium polymer cells selected for this project provide the necessary power discharge capabilities and collectively weigh less than 30 pounds. The cells boast a capacity rating of 6000mAh and will operate the vehicle at a moderate, constant velocity for up to an hour. A third-party battery monitoring system connected to the cells will monitor the cells during both charging and operation, ensuring that both the battery cells and the personnel operating the vehicle are protected at all times.

Full electric and hybrid vehicles have gained significant popularity over the past several years, and battery systems have grown continually larger and more complex to meet a widening variety of needs. Improving the design and implementation of onboard battery systems will improve the responsiveness and operational range of electric vehicles by enabling the batteries to deliver greater amounts of energy in a more efficient manner, and by allowing the batteries to recover energy that would normally be lost as heat during braking.



Vandal Formula Electric Vehicle Team
Formula Electric Vehicle Battery and Battery Management System

Background

For several years, the University of Idaho's Vandal Racing team has designed vehicles to compete in the Society of Automotive Engineers (SAE) Formula racing competition, a group of annual competitions designed to give students practical engineering experience by designing racecars. The growth of the consumer electric vehicle market over the past decade has prompted the SAE to expand the Formula racing competition to include electric vehicles (EV). The Vandal Racing team now wants to commence work on an EV with the intent of competing in the SAE Formula EV competition within two to three years. To this end, the racing team has approached the Department of Electrical and Computer Engineering to design the powertrain for the new vehicle.

The powertrain is responsible for propelling the vehicle by converting energy from fuel to mechanical energy and transmitting it to the wheels. The powertrain of the proposed electric vehicle has four key systems: the batteries, the motor(s), the control system, and the regenerative braking system. A proof-of-concept regenerator has already been developed for the vehicle, and an electric motor is currently under development. This project intends to design the battery system (with an appropriate monitoring system) that will provide electric energy to the motor(s) and can also interface with the proposed regenerator system.

The desired battery system must be able to discharge large amounts of energy quickly (up to 85kW) when maximum acceleration is desired, yet must also hold enough energy to drive the vehicle at moderate velocities (35 km/hr) for an extended period of time (35-40 mins). Additionally, the battery system must be as lightweight as possible in order to maintain a high power-to-weight ratio.



Problem Definition

Goals

- Approximate the load the battery system will need to drive
 - Simulation
 - Discharge testing
- Locate battery cells that meet the performance specifications
 - Test battery cells to verify performance
- Design or acquire a battery management system

Deliverables

- A completed design for the battery system
- A constructed prototype of the battery system
- A single-cell heat transfer model of the batteries

Specifications

- 1200lb car with driver
- Batteries should output at 240-300V

Constraints

- Maximum energy draw cannot exceed 85kW
- Minimize weight where possible



Project Plan

Items Completed

Table 1. 1st Semester Design Tasks

Completed Tasks	Timeframe
Determine what project subset to complete	Mid-January to mid-February
Research means of energy storage	February to March
Model load characteristics using Simulink	March
Locate suitable energy storage medium	March to mid-April
Locate battery management system	Mid-March to mid-April
EXPO Showcase	April (EXPO April 26 th)
Finalize interim report	Mid-April to May

Items to Complete

Table 2. 2nd Semester Design Tasks

Remaining Tasks	Timeframe
Acquire batteries & BMS	September
Construct test platform	Mid-September to mid-October
Test batteries & BMS	October
Adjust battery parameters	Mid-October
Create single-cell heat transfer model	Mid-October
Integrate components into unified design	Mid-October to November
Adjust final design	December
Snapshot presentation	December 6th
Finalize design report	December 13th



Concepts Considered

A MATLAB model developed by the hybrid vehicle team was used to estimate the range of loads that a potential battery system must power (see [page 13](#)). Two SAE competitions were singled out for analysis: the acceleration event and the endurance event. The acceleration event is effectively a drag race, where the objective is to accelerate down a 75 meter stretch of road as quickly as possible. The endurance event is a test of longevity, where the vehicle must navigate a 22 kilometer track at moderate velocities (average: 35 km/hr), with an expected completion time of 30 minutes. The acceleration event will require maximum output power from the batteries, within the 85kW limit set by the 2013 SAE rules, while the endurance event will require up to 30 minutes of near-continuous discharge. By focusing on these two events, the battery system will be capable of covering the other events that fall in between in terms of peak load and operation time.

Estimation of Parameters

Table 3. Model-generated load specifications for electric vehicle

35 MPH

Quantity	Peak	Continuous
Power	26.43 kW	1.872 kW
Current	96.91 A	6.864 A
Voltage	300 V	300 V

60 MPH

Quantity	Peak	Continuous
Power	77.67 kW	5.961 kW
Current	284.8 A	21.86 A
Voltage	300 V	300 V

100 MPH

Quantity	Peak	Continuous
Power	215.8 kW	22.29 kW
Current	791.1 A	81.74 A
Voltage	300 V	300 V

Table 3 lists a set of load specifications for the system generated by the MATLAB model for a 1000lb vehicle with a surface area of 0.95 m². At 300V, the batteries will need to discharge 77.67kW of power to accelerate the vehicle to 60 mph over five seconds, which comes within



10% of the maximum allowable power discharge. This value was chosen as the target max discharge rate in order to leave at least a 5% buffer between it and the maximum allowed rate. For a 35 mph continuous discharge rate, the required discharge rate at 300V is 1.872kW via a 6.684A current. Under ideal circumstances, the selected method of energy storage must be able to supply this 6.7A current for at least 30 minutes. The actual storage capacity will need to be greater in order to account for non-ideal factors such as increased current draw during acceleration. Additional non-ideal factors are listed on [page 13](#) under the description of the MATLAB model. This figure also does not account for energy regained due to regeneration.

In order to move ahead with component selection, it was necessary to specify the method of energy storage. Three different methods of energy storage were examined for this project: a flywheel, ultracapacitors, and Lithium-ion cells.

1. Flywheel

A flywheel stores energy as kinetic energy, with the quantity of energy stored being directly proportional to its rotational velocity ω . Energy can be placed into the flywheel by applying torque to the shaft with a motor; similarly, energy can be removed from the flywheel by using the shaft torque to power a generator.

Flywheels offer good energy density like Lithium-ion batteries do, but can be charged faster, and are not a fire hazard. However, the need for mechanical bearings results in energy losses due to friction, reducing the amount of time that the flywheel can store energy. The inertia of the flywheel can destabilize the car, introducing handling problems. The flywheel itself is a heavy mass of steel which compromises the desire for lightweight energy storage. Most importantly, the bearings wear over time and represent a potential point of catastrophic failure. A dismantled flywheel will continue to spin until it has discharged all of its kinetic energy.

The safety of the driver, car designers, and bystanders is a paramount concern. For this reason, along with the aforementioned practical concerns, the flywheel storage system was investigated, but not strongly considered.



2. Ultracapacitors

A small number of ultracapacitors are already present in the design as part of the regenerator, but could also be extended to serve as the primary means of energy storage. The primary advantage of ultracapacitors is their light weight and their ability for rapid charging and discharging. They also have no inherent risk of fire like Lithium-ion batteries have.



Ultracapacitors make sense when high power density is a necessity. However, this electric vehicle does not need the extremely high power density that they offer, neutralizing their greatest advantage. The energy density of ultracapacitors is also very poor when compared to Lithium-ion batteries. This disadvantage could be resolved by buying many ultracaps and using parallel arrangements to boost their effective energy density, but such an arrangement is highly inefficient in terms of mass and volume.

The most damning argument against ultracapacitors is their price; the ultracaps specified for use in the regeneable power densities and far superior energy densities. As a result, an ultracapacitor-barator sold for \$64.06 per unit, almost double the price of some Lithium-ion cells examined for this project that offered accepted storage system was deemed to be an inferior solution.

3. Lithium-ion cells

Lithium-ion cells have become widespread in consumer electronics over the past two decades due to their good energy density, power density, and light weight. Multiple cathode and anode chemistries exist, all of which offer different performance characteristics and risks. After some independent research and consultation, the focus was turned to lithium polymer (LiPo) batteries, so named because the lithium electrolyte is stored not in a liquid solution, but in a semi-solid polymer composite.



LiPo cells offer a good balance of energy density and power density in a lightweight package. The semi-solid nature of the electrolyte allows manufacturers to design more space-



Vandal Formula Electric Vehicle Team
Formula Electric Vehicle Battery and Battery Management System

efficient packages, such as rectangular cells that are easily stackable. The semi-solid electrolyte also eliminates the need for a rigid containment vessel, increasing the weight savings even more.

LiPo cells have many of the same flaws as most other Lithium-ion cells, including the risk of fire if a cell is overcharged or overheated. To this end, a battery management system (BMS) must monitor the voltage, temperature, and state of charge of the cells at all times. LiPo cells also cannot be deeply discharged without damaging the charge-storing characteristics of the cell. LiPo cells also cannot be charged using high current without potentially damaging the cells. A LiPo-specific charger is required to mitigate this risk.

Concept Selection

Energy Storage Method

Of the three systems considered, Lithium polymer cells were chosen because they offered the most pertinent performance characteristics for this project: good energy density and good power density in a relatively lightweight, compact package. The risks associated with LiPo cells are significant, but the proliferation of Li-ion cells in recent years has given rise to a new group of companies that offer LiPo-specific chargers and management systems to mitigate these risks.

Battery Management System

As highlighted above, several companies now offer management systems tailored to LiPo cells. The decision was made to use one of these third-party systems in order to save time. A professionally-designed management system will also likely offer additional features over a self-designed system as well as manufacturer support in the event of failure.

Charger

A third-party charger was acquired from the hybrid team for battery testing purposes. The vehicle is currently slated to use a combination charger/regenerator currently being designed by another team.



System Architecture

General Powertrain Architecture

The overall powertrain of this vehicle can be broken down into two electrical networks and four key systems: the tractive (high voltage) system, containing the motors, the batteries and charger, and the regenerator; and the grounded low-voltage (GLV) network containing the control system which operates the other components. A basic schematic of the overall powertrain is shown in Figure 1 below.

Figure 1. Basic schematic of overall powertrain

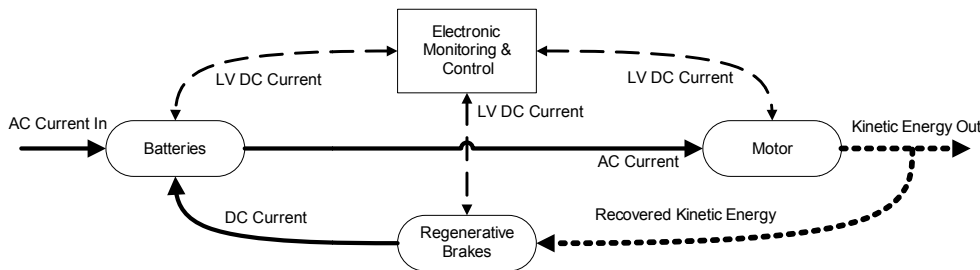

The motors consist of four custom designed three-phase 300V linear induction machines currently being developed by Jaz Veach. These motors will be mounted within the wheels, with the motors mounted within the front wheels also doubling as generators for the regenerator.

The control system consists of electronics connected to the GLV network. Each wheel-mounted motor will have its own motor controller, connected to a central control unit. The central control unit will control the operation of the motors, the interface between the regenerator and batteries, and any other functions that require intelligent control. Additional GLV network components include the electrical fault monitor, brake system plausibility device, battery management system, and the other mechanical systems that constitute the tractive system shutdown circuit. A failure at any point in the shutdown circuit will open the accumulator isolation relays and electrically isolate the batteries from the rest of the system.

The battery system consists of the accumulator container, which contains the batteries and BMS components, and the charger/regenerator. The charger/regenerator is a separate unit



that will intelligently convert either AC (level 1 & 2) or high-voltage DC (level 3) to a current that is acceptable for the LiPo cells, and will also recover energy from the motors to return to the cells during operation.

The motors and regenerator, as partially pre-existing systems, are considered completed work and are detailed below:

Figure 2. Motors and regenerator, as partially pre-existing systems

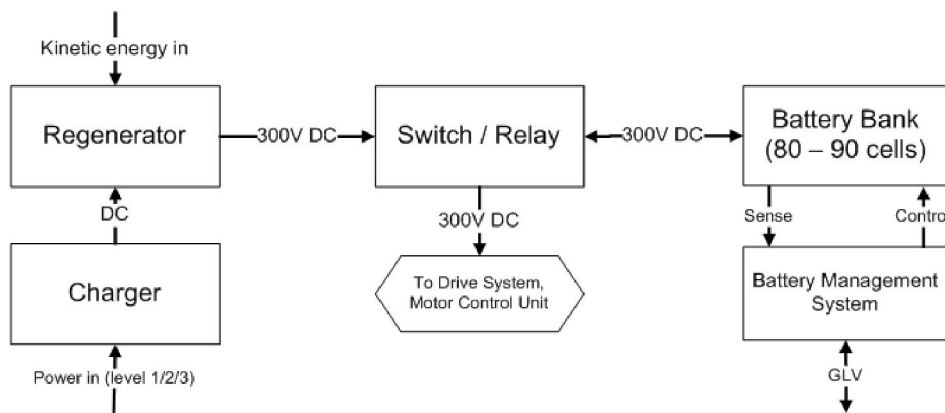

Completed Work

1. Components

The motors will consist of four custom designed three-phase 300V linear induction machines currently being developed by Jaz Veach. These motors will be mounted within the wheels, with the motors mounted within the front wheels also doubling as generators for the regenerator.

The regeneration system, designed by Jaz Veach, is a proof-of-concept system for converting kinetic energy normally lost during braking into electrical energy that can be returned to the batteries. When the brakes are applied, the front-wheel mounted induction motors reverse direction and generate electricity that is fed into a high voltage ultracap bank - buck converter - low voltage ultracap bank - boost converter sequence before being transmitted through an



electronically controlled relay to the batteries. The high voltage bank increases the amount of energy that the regenerator can recover while the low voltage bank supplies the batteries with a current they can safely accept. A charger can also take advantage of the low-voltage bank and boost converter to charge the batteries. Since the regenerator was designed around a 50V motor and an overall lighter vehicle, it will need to be scaled up to handle the increased amount of energy available.

2. Models

As part of the development of the hybrid vehicle, a MATLAB model that estimates required system power for constant velocity and acceleration scenarios was obtained for use in developing the electric vehicle. The constant velocity model estimates required power based upon the vehicle's weight, surface area (for drag), and desired velocity, and the track's surface grade. The acceleration model estimates required power based upon the vehicle's weight, desired final velocity, and desired acceleration time. These models were used to estimate the loads the battery system will must be able to supply.

The power consumption model is limited in its scope and cannot account for all operating conditions, such as the quality of the track surface, weather, changes in weight or surface area, or spikes in power consumption needed to overcome reactive forces encountered during turns. The model is an excellent starting point for determining operating parameters, but the final battery design must be robust enough to account for the factors not present in the power model.



3. Hybrid Vehicle Battery System

The hybrid vehicle team has constructed its own battery system for use in a hybrid electric vehicle. The system consists of 29 3.7V LiPo cells arranged in series and monitored by an EMUS battery management system. The hybrid battery system does not include regeneration and will provide only about 10% of the total energy stored onboard the vehicle. The hybrid vehicle team provided advice with regards to choosing the cells, choosing a management system, constructing the system, and dealing with other concerns that must be taken into account when connecting a large bank of batteries together.



Component Selections

The proposed battery system will consist of 81 series-connected Haiyin 3.7V LiPo battery cells. The exact number of cells was chosen so as to provide power to the motors at approximately 300V. The system will be monitored and protected by an EMUS battery management system.

1. Batteries

The batteries selected for use are Haiyin P68100120F-50C Lithium polymer cells. Based on a Lithium Cobalt oxide chemistry, these cells are rated at 6000mAh, meaning that they should be able to supply 6A to a load for one hour. The cells boast discharge rates of 300A continuous and up to 400A burst. Each cell has a mass of 150g, has dimensions of 6.8 x 100 x 120 millimeters, and comes with minimal packaging (i.e. no hard plastic shell). 81 cells will occupy a volume of 0.00661 m³ (6.61L) and weigh approximately 26.8 pounds. It must be noted that these figures do not include the mass and volume of any necessary structural components or connections. A complete manufacturer spec sheet is included in [Appendix A](#).



2. Battery Management System

The EMUS battery management system is the BMS of choice. The EMUS BMS consists of a network of up to 255 cell modules connected to each battery cell, and a central unit that connects to the cell modules. The EMUS monitors each cell's voltage, temperature, and state of charge (SoC). In the event that any cell experiences a large deviation in voltage, temperature, or SoC, the BMS can disconnect the cell from the network in order to prevent fire and/or cell damage. The BMS also applies charge leveling during charging so that all cells have an equal SoC to improve longevity. The BMS can be controlled via CAN, RS-232, and USB, and supports monitoring data transmission via Bluetooth (requires a separate antenna) to a smartphone for live observation. Additional specs are included in [Appendix X](#).

Comment [p2]: You did not give this spec so work on this as appendix B



EMUS battery management system: central unit (left) and cell modules (right)



Test Procedures & Results:

Testing Platform

The test platform for the batteries consists of a repurposed wooden “fuse block.” Cell terminals are inserted between two copper conducting plates and secured into place by tightening two metal bolts. The bolts contain terminals that accept 4-AWG cables such as what is used in the power lab. Attached to the copper conducting plates is a cell module that reports test data to the BMS. A multimeter and DC current clamp were also used to collect data during testing.

The load was a 0.088Ω nichrome bank built as part of a separate project. The bank consists of 17 nichrome wires connected in parallel using copper bus bar. 4-AWG cables were connected to the ends of the load bank. The relay network and cooling fans also present in the picture were not used in this project. The nichrome bank was selected as the load over a standard power resistor bank because nichrome alloy features both low resistance and a high melting point, allowing it to safely dissipate large amounts of power. In between the nichrome bank and the test platform was a DC breaker used to control current flow and a current sensor connected to the BMS.



Test Setup



Nichrome bank



Batteries were charged by a Revolectrix PowerLab 8 charger and accompanying DC power supply, both of which were borrowed from the hybrid team. The PowerLab 8 features multiple charging programs for LiPo cells; for these tests, the “Accurate Charge” program was used with an 8.0A charge current. Higher charge currents and multi-cell charge capability requires additional hardware and lower resistance banana-jack cables. A spare relay was placed on top of the cells during charging and discharging to provide compression.

1. Discharge Characteristics

Where is the text

Heat Transfer Model

The purpose of creating a heat transfer model is to determine the lightest and most robust non-conducting pressure containment plates and heat dissipation fins. In order to reduce weight of the battery pack, a heat transfer model must be created in order to predict max internal temperatures of the battery pack when subjected to various fin geometries, stacking arrangements, ambient temperatures, and air flow conditions.

To begin modeling, a single cell heat model was developed and used to predict internal temperatures. Our battery team provided voltage, current, and top and bottom surface temperatures to Gillette Zenner who then created a heat transfer model using Matlab and Simulink (see Table 4.). The model takes current, voltage, and surface temperature as input and predicts the maximum internal temperature of a single cell.

Original tests were performed between operating voltages listed on the cell data sheet. However, after plotting heat generation as a function of the test data, it was observed that thermal runaway may be a concern. Near the end of the test, heat generation appeared to be exponential in shape, with positive first and second time derivatives. Concerned that max heat generation was then largely unknown, Gillette recommended an extended test to see what value of max heat generation would be reached. Extended testing showed heat generation peaks shortly after the minimum cell voltage (2.8 Volts) upon which the first test data domain ended.

Comment [p3]: I do not think it should be a name here. **Gillette Zenner** can go to acknowledge which is a new page after cover paper



Table 4. Heat transfer model using Matlab and Simulink

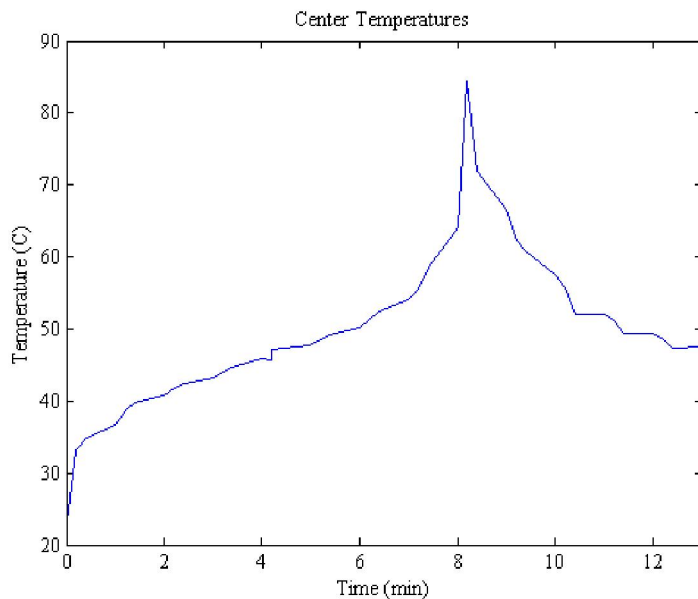

From the above plot, it can be observed that center temperatures can reach levels that may cause permanent damage to the Emus BMS sensors and the batteries themselves (see Table.5). With peak values around 85 C (185 F), it was observed that to correctly manage the heat generation of the batteries, the Emus BMS controller would need to be programed to shut off the battery pack or bypass individual cells after voltage drops below 2.8 Volts. This will prevent damage to the batteries as well as allow for a lower max heat dissipation rate as a design constraint for the cell packs and battery containment vessel.

For future work, the thermal battery model would need to be expanded to analyze multi-cell arrangements and fin geometries. This would allow future teams to perform battery box design optimization.



Table 5. Internal Resistance and Heat Generation

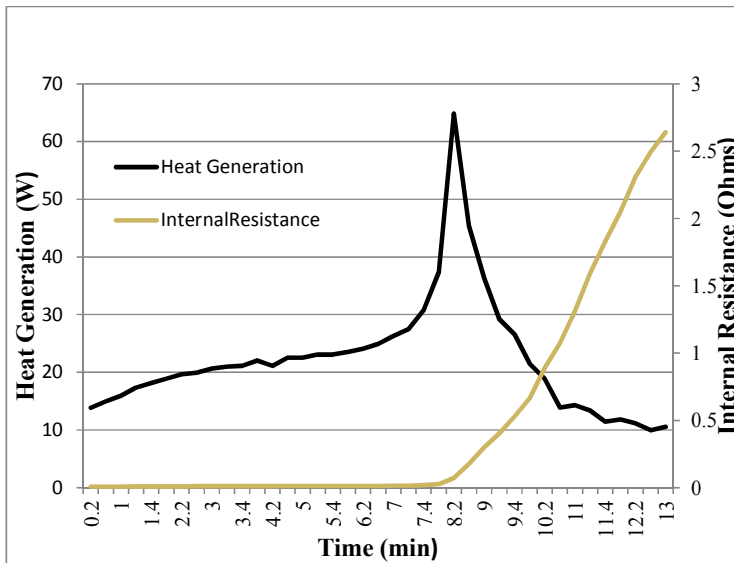

System Assembly

General Plan

Three design goals were considered when determining how to physically arrange the cells: serviceability, connection integrity, and volume minimization. Serviceability refers to how easy the product will be to troubleshoot and repair. In the event that a faulty component has to be replaced, the servicer should have to disassemble as little of the battery bank as possible. Connection integrity is self-explanatory: connections have the greatest probability of failure by far in most systems and the battery bank is no exception. This includes using copper bus bar connections between cells and avoiding the use of long cable runs wherever possible in order to minimize resistance. Volume minimization is important because there is only a finite amount of room inside the body of a formula vehicle and the battery bank must share that space with other components as well.



Vandal Formula Electric Vehicle Team
Formula Electric Vehicle Battery and Battery Management System

The battery system built by the hybrid team places all thirty cells in series both electrically and physically. Their design features copper bus bar connections and a combination of all thread driven through the cell terminals and an aluminum frame to hold the batteries together. Other required components are secured to the walls and floor of the container using Velcro. This design provides solid connections in a relatively small volume, but is difficult to service: if the 15th cell in the series needs to be replaced, fourteen cells and their accompanying connections will need to be disassembled in order to reach the bad cell. While it may not be a significant problem for the hybrid team to deal with, a larger design utilizing 80+ cells must take steps to ensure that cells can be serviced quickly.

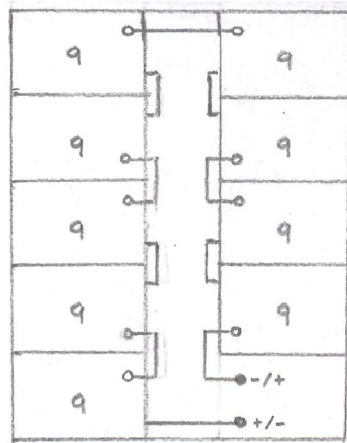

Bank schematic

The format ultimately chosen for this project is a “block” design of 81 cells arranged into nine removable blocks of nine cells. The block format provides a balance of the three desired design goals. First, by arranging the cells into removable blocks of nine, a bad cell can more easily be accessed. In the event of a bad cell, a servicer would first remove the block from the system, and then remove four cells at the most to reach the bad cell. This arrangement saves significant amounts of time in system disassembly, reassembly, and prevention of errors during reassembly.

Second, the use of blocks allows for high-integrity connections between cells within a block. The highest integrity connections would be achieved by using the hybrid team's pure



Vandal Formula Electric Vehicle Team
Formula Electric Vehicle Battery and Battery Management System

series configuration where all cells are locked into one block, but as stated before, this configuration would be difficult to repair. The use of small blocks allows for the use of copper conductors between cells while preserving a high degree of serviceability for the entire system. Nine cells per block was chosen in order to eliminate long cable runs between blocks by ensuring that the negative terminal of the final cell of a block would be directly next to the positive terminal of the first cell of the next block.

Finally, the use of 9x9 blocks allows the battery bank to fit within a relatively compact 24 x 18 x 12 inch package. While it's not the most compact arrangement possible, the relative symmetry of the package's dimensions should provide future teams with flexibility regarding where to place the bank within the vehicle.

The construction of the full battery system proved to be beyond both the time and financial limits of this team. The decision was made to construct a single block of the system as discussed below.



Block Plan

Within a block, there are another set of design goals to be met. A block must be able to hold all of its cells together, be as lightweight as possible, and prevent electrical shorts from occurring. The design chosen was a variation of the hybrid team's battery bank: the cells would be compressed by aluminum plates, aligned and secured using all thread, and connected to one another via copper blocks.

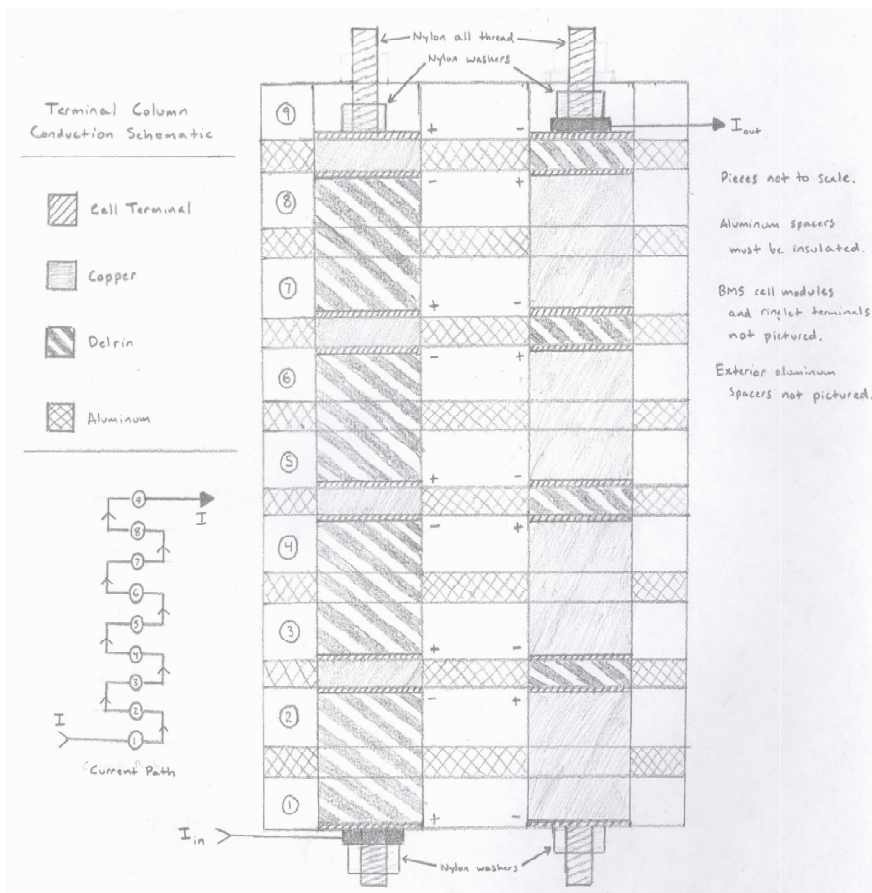

FRONT VIEW SCHEMATIC



Vandal Formula Electric Vehicle Team
Formula Electric Vehicle Battery and Battery Management System

The cells were then arranged in an opposite-facing manner, so that the polarity of terminals alternates. Copper conducting blocks were placed in between certain positive-negative terminal gaps as shown to connect the cells together, while non-conducting gaps were filled with an insulating plastic called Delrin. BMS cell modules were inserted into the system were necessary to provide monitoring and management capabilities. The copper and Delrin blocks were milled to specifications and an 8mm wide hole drilled through the middle of each block, while the cell terminals had 8mm wide holes punched through them. Non-conducting nylon all thread was strung through these holes and secured on both ends with nylon nuts to hold all the parts together.

Aluminum plates coated with electrical tape were inserted in between the cells to compress the cells and hold them in place. Larger aluminum plates coated with electrical tape and featuring drilled outside holes were placed on the ends of the cell block. The cell block is held together and compressed using nylon all thread and nuts strung through the outside holes. A 3D rendering of a cell block was created in SolidWorks to illustrate what it should look like when assembled.

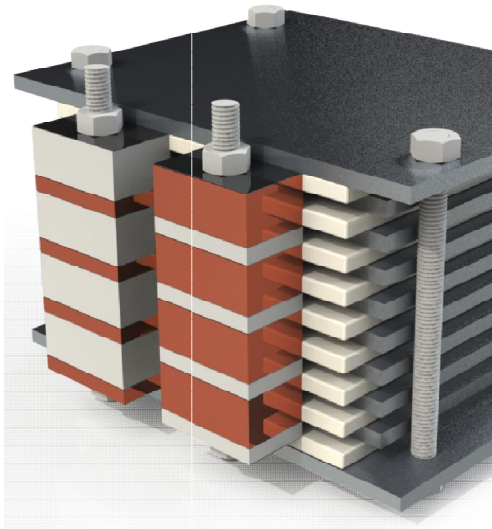



Vandal Formula Electric Vehicle Team
Formula Electric Vehicle Battery and Battery Management System

Aluminum and copper was acquired through the UI facilities department. Other equipment like Delrin, all thread, nuts, washers, and tape was either bought online (McMaster Carr) or at local hardware stores. The aluminum, copper, and Delrin were milled into blocks according to specifications by ME volunteers in the Gauss-Johnson machine shop.

Assembly of the block took roughly 90 minutes, which included a partial tear down of the completed system after a BMS cell module was determined to be bad. Identification and replacement of the bad cell module took about 10 minutes, and served to validate the serviceability design goal. For the moment, the data lines of the cell modules are twisted together and secured using electrical tape. A multimeter read 36.4 V across the cell block, which indicates that all cells are connected.

When included as part of the full system, this block would have short, ring terminal tipped heavy gage cables tying cell blocks together. The ring terminals would be held in contact with cell terminals using the all thread. Interblock BMS data line connections should ideally have modular connectors for easy disconnection when a block needs to be removed from the system. These modular connectors could be extended to intrablock BMS data line connections if desired.

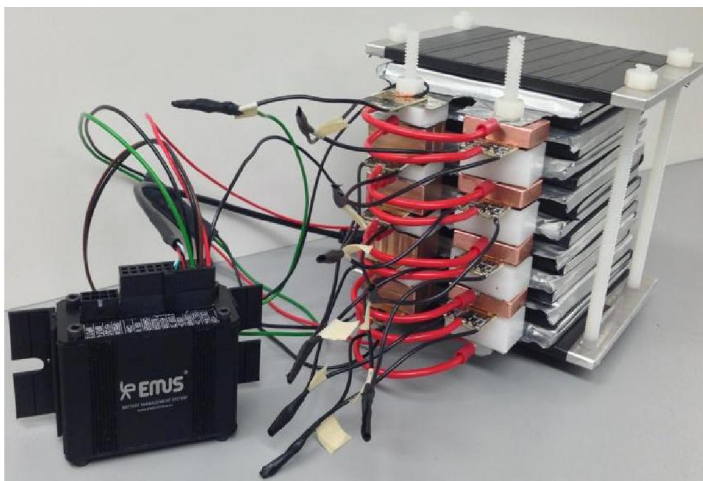

Final Project

Comment [p4]: Please move to acknowledge page



Future Work

Full System Construction

The primary next step is to acquire additional cells, cell modules, and other equipment and construct the full battery system. The full battery system must then be tested to determine whether it meets final performance specifications. Part of the construction of the full system requires specifying an interface with which to connect to the charger/regenerator. This also requires the next team to assist the current team with testing of their charger/regenerator unit.

The prototype block assembled by this team was not optimally constructed due to time constraints and the benefit of hindsight. Some ideas for refinement of the design include:

- Use of thinner aluminum/other material spacer plates - potential weight savings.
- More precisely milled Al/Cu/Delrin blocks - related to the previous point, the idea is to avoid having the cell terminals be forced to bend in order to make their connections.
- Better placement of cell modules - make sure that cell modules and ringlet connections are made to the outside of terminal-copper-terminal connections; the modules/ringlets should sit on top of current flow, not in the middle of it. Alternatively, cell modules and ringlets could be soldered to their corresponding copper blocks.
- Alternate insulation - electrical tape is cheap, but thick, heavy, and ugly. Kapton tape was used by the hybrid team for their insulation; it is much thinner and lighter.

Integration of Safety Electronics

Another required task will be to integrate the necessary safety electronics into the battery system. This includes, but is not limited to: insulation monitor, accumulator isolation relays (AIR), interfacing with the grounded low-voltage (GLV) system, the accumulator management system (fulfilled by the BMS, but may not be configured to provide necessary functionality right now). For a full list of electronics required in the accumulator shutdown loop, consult the Formula EV rules. Some of these tasks may be assumed by the team(s) tasked with designing the GLV system.



Containment Vessel Design & Construction

An additional task will be to design a containment vessel for the entire battery system. The vessel must secure the battery blocks and any electronics that must be located inside the containment vessel. The vessel itself must be fireproof, shatter and impact resistant, be as lightweight as possible, be able to adequately cool the system, and fit within the confines of the vehicle. Consult the Formula EV rules for additional regulations related to the containment vessel. Any future team assigned this project is strongly advised to bring mechanical engineers onboard as quickly as possible. Future teams are also advised to look into alternate means of containing the batteries, such as the side pods employed by the University of Kansas' formula team.

Block Diagram v2 2/26/2013

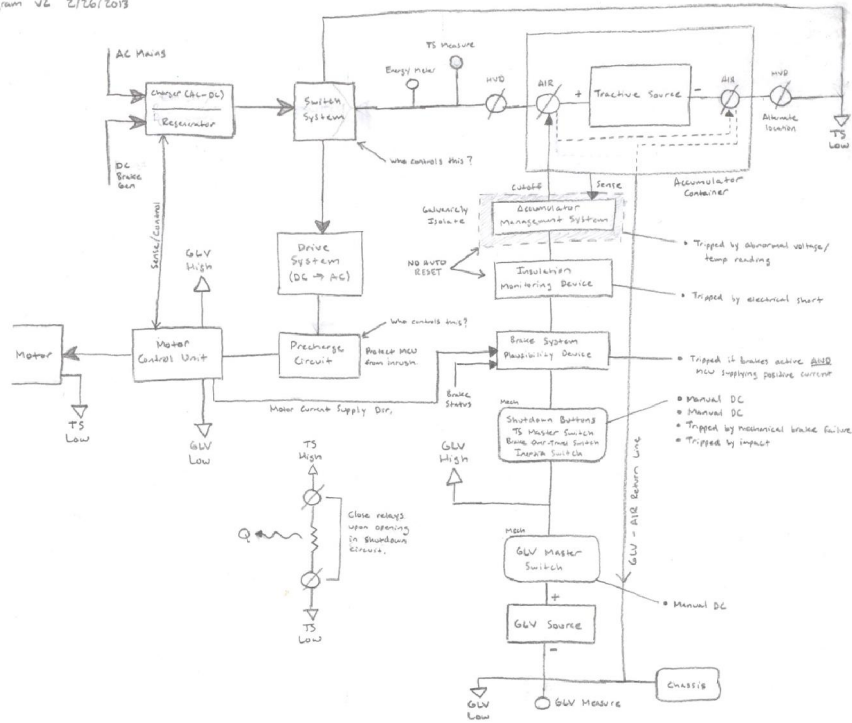

Future Complement System



Appendix A: Battery Manufacturer Spec Sheet



Cell Specification of P68100120F-50C

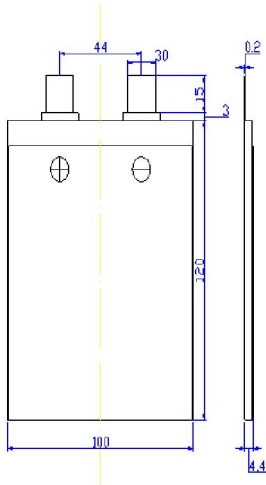

★ Typical Capacity ^①		6.0Ah
★ Nominal Voltage		3.7V
★ Charge	Max. Current	30A
	Voltage	4.2V±0.03V
★ Discharge Condition	Continuous Current	300.0A
	Peak Current	400.0A
	Cut-off Voltage	2.8V
★ AC Impedance(mOHM)		<2.5
★ Cycle Life【CHA:0.5C,DCH:0.5C】		>500 cycles
★ High Rate Cycle Life【CHA:2.0C,DCH:30.0C】		>80 cycles
★ Dimension	Temp. Discharge	-20°C~50°C
	Thickness (T)	<6.8mm
	Width (W)	<100.0mm
	Length (L)	<120.0mm
★ Weight (g)		150.0±3.0g

①Typical Capacity:0.5CmA. 4.2V~2.8V@23°C±2°C

Page 1



Vandal Formula Electric Vehicle Team
Formula Electric Vehicle Battery and Battery Management System

Appendix B: Battery Management System Manufacturer Spec Sheet

Comment [p5]: Work on this page