



# NEUROTOUCH DESIGN REVIEW

Mazen Aljawi, Brooke Deans, Christina Gibbs,  
Matt Harlow, and Brendan Souvenir

# PROBLEM STATEMENT

Create a precise, sanitary, and safe brain stiffness inspection method

- Why?
  1. Subjective measurement
  2. Rely on experience
- Solution:
  1. Create an easy-to-use, hand held device
  2. Multiple sensors used to calculate force applied and distance traveled to brain tissue

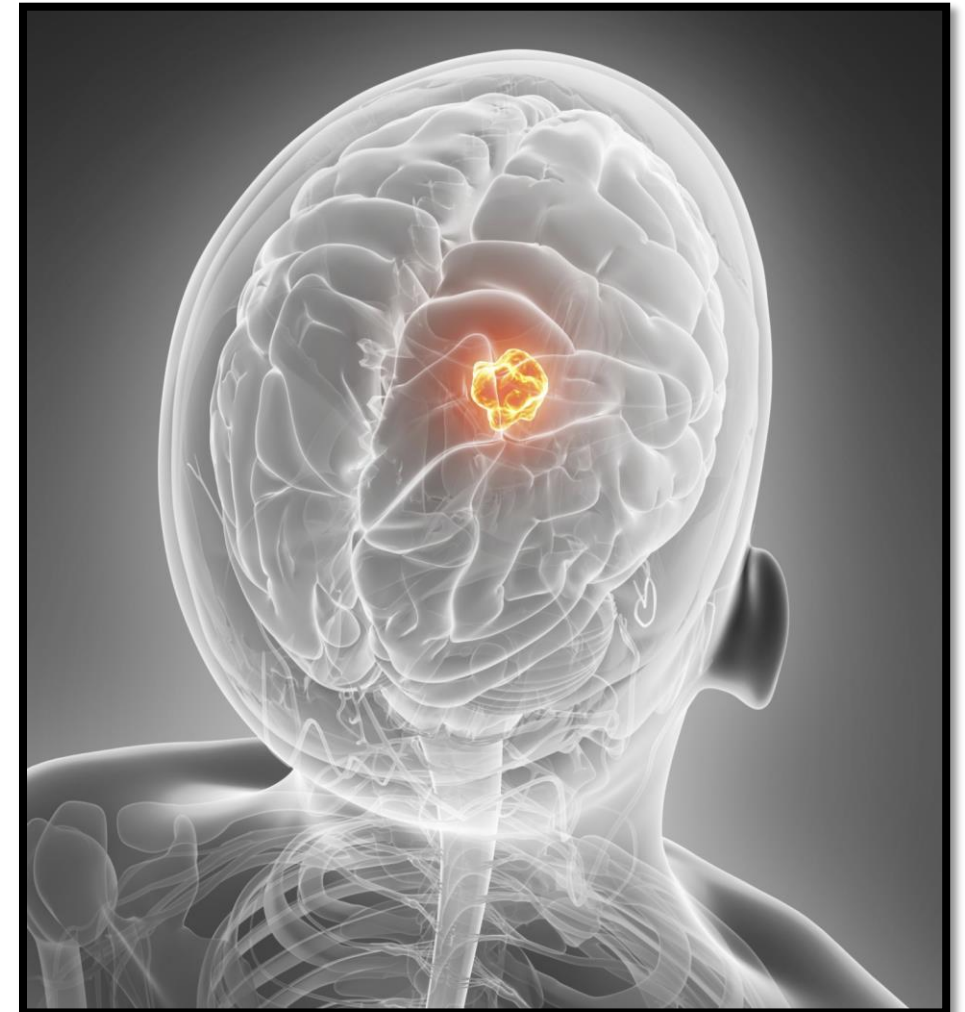



# PROJECT LEARNING

## Biological Concepts

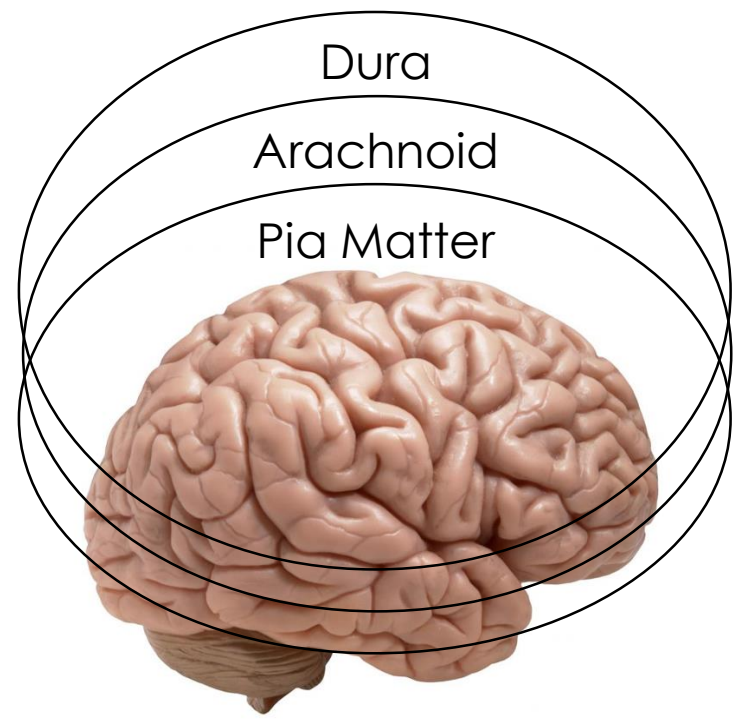

## Mathematical Principals

- Hertz Model

$$F = \frac{4}{3} E' \sqrt{r(\Delta h_2 - \Delta h_1)^3} \frac{1}{E'} = \frac{1 - \nu_1^2}{E_1} + \frac{1 - \nu_2^2}{E_2}$$

- Levenberg-Marquardt Algorithm

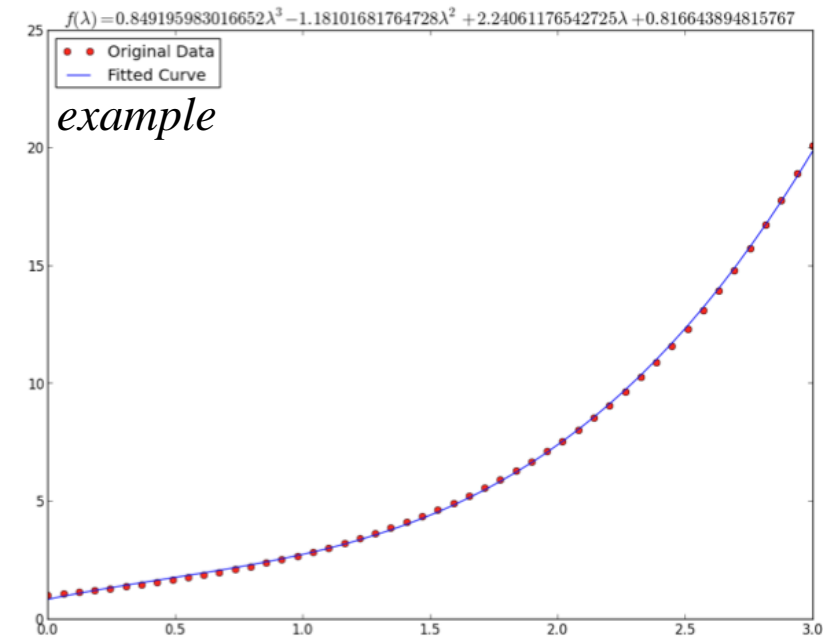

# IN VIVO/ IN SITU METHOD: INDENTATION

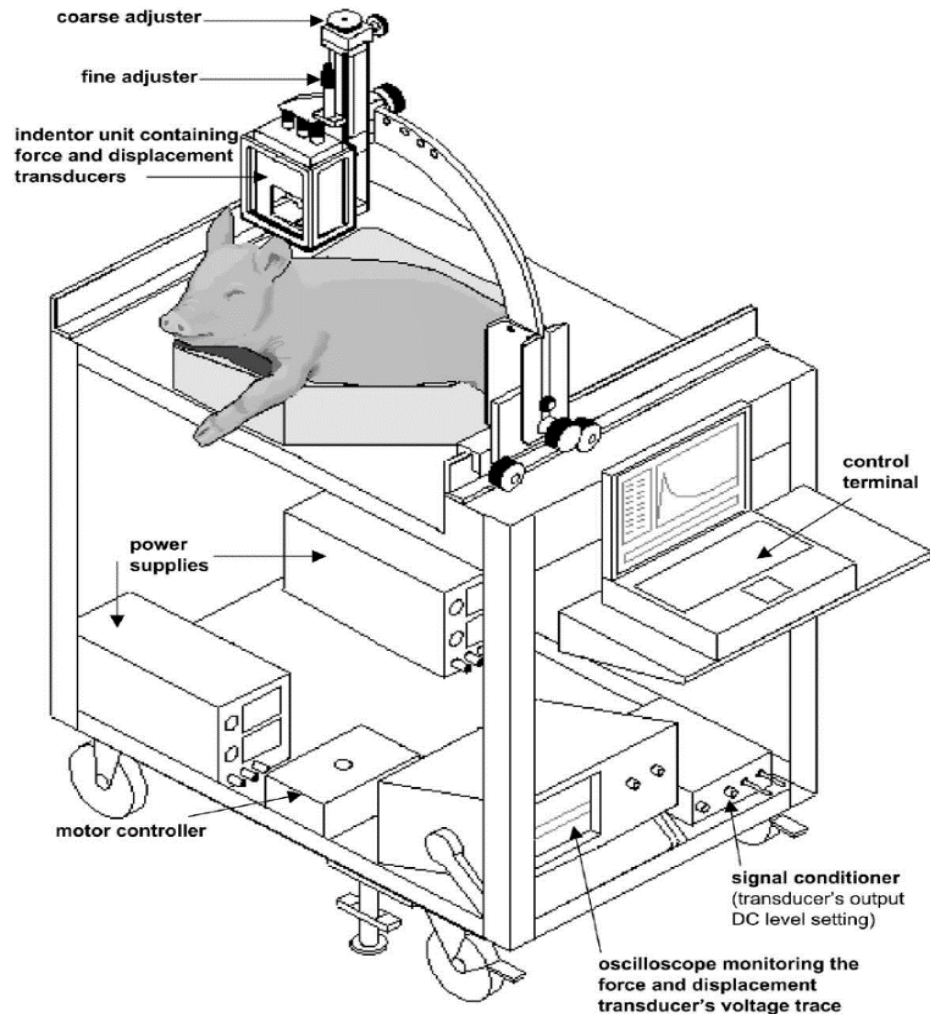

# PROJECT LEARNING

## Applying Levenberg-Marquardt Algorithm

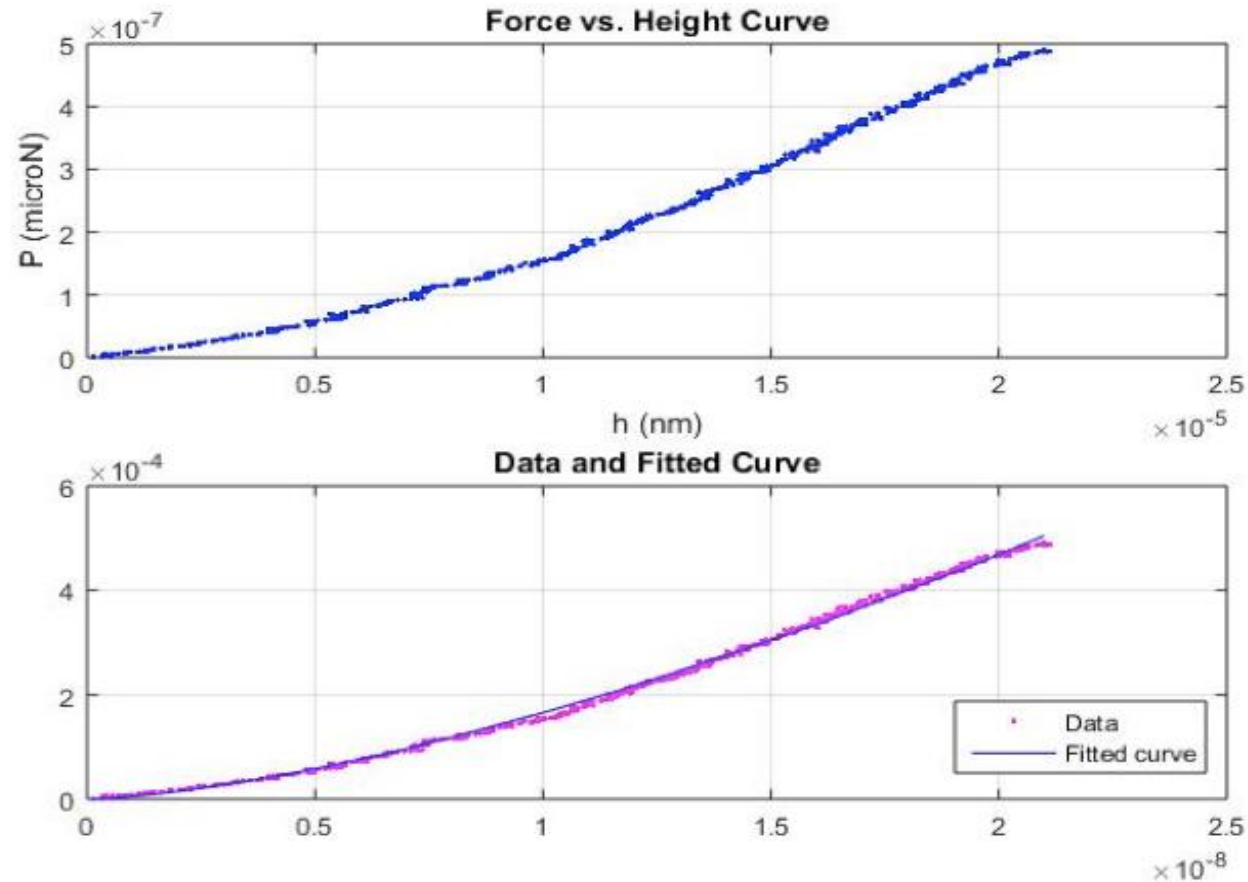

- Test data supplied from Dr. Maughan
- Creating code for future device
- Understanding applicable results

# DEVICE SPECIFICATIONS

Specification	Target
Hand-Held	<ul style="list-style-type: none"><li>• Ergonomic</li><li>• Slip-resistant grip</li></ul>
Quick Results	<ul style="list-style-type: none"><li>• 30-60 seconds after test</li></ul>
Sterile	<ul style="list-style-type: none"><li>• Autoclave</li><li>• Easily interchangeable, disposable end effector</li></ul>
Ease of Use	<ul style="list-style-type: none"><li>• Less than 5lb user force required</li></ul>
Operation	<ul style="list-style-type: none"><li>• 1 cm diameter indenter tip</li></ul>
Precision	<ul style="list-style-type: none"><li>• Sub-mm distance sensor</li></ul>

# DESIGN CONCEPTS: MECHANICAL

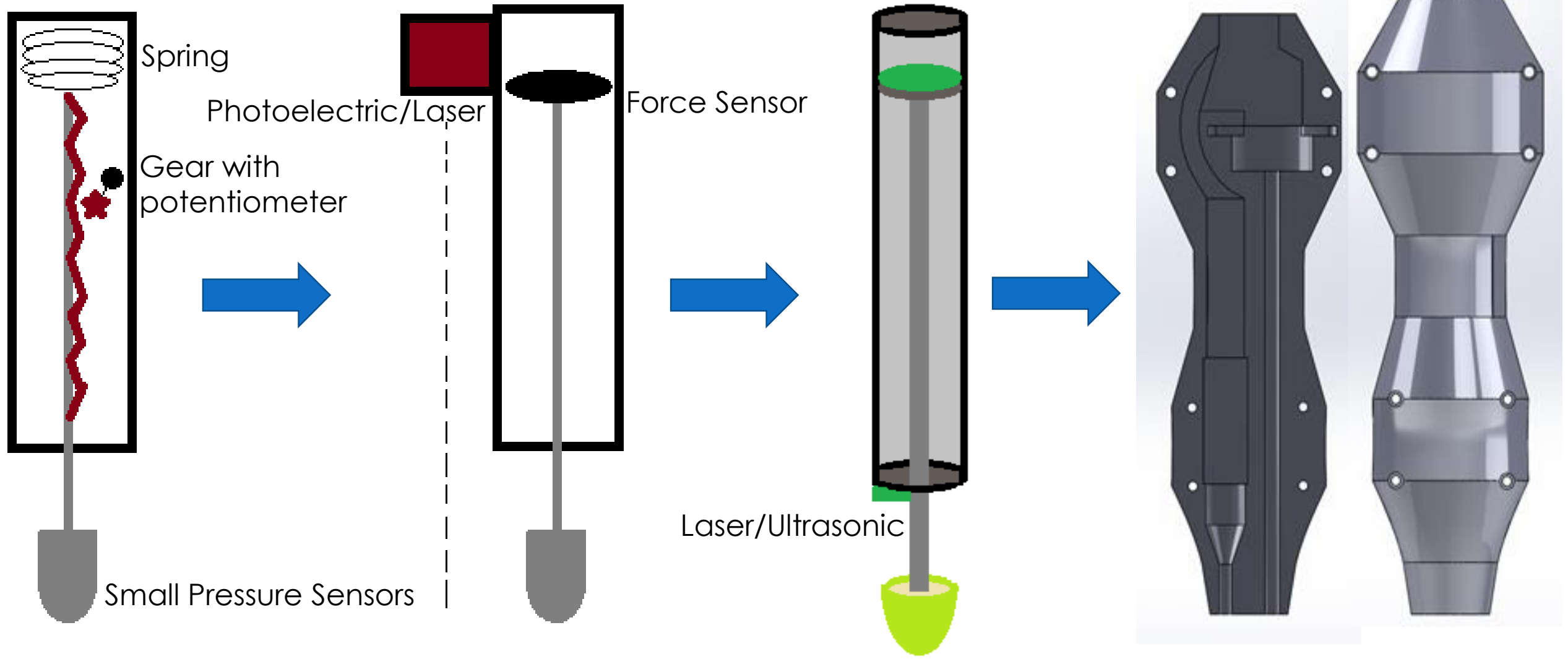



# DESIGN CONCEPTS: ELECTRICAL

## First Iteration

## Second Iteration

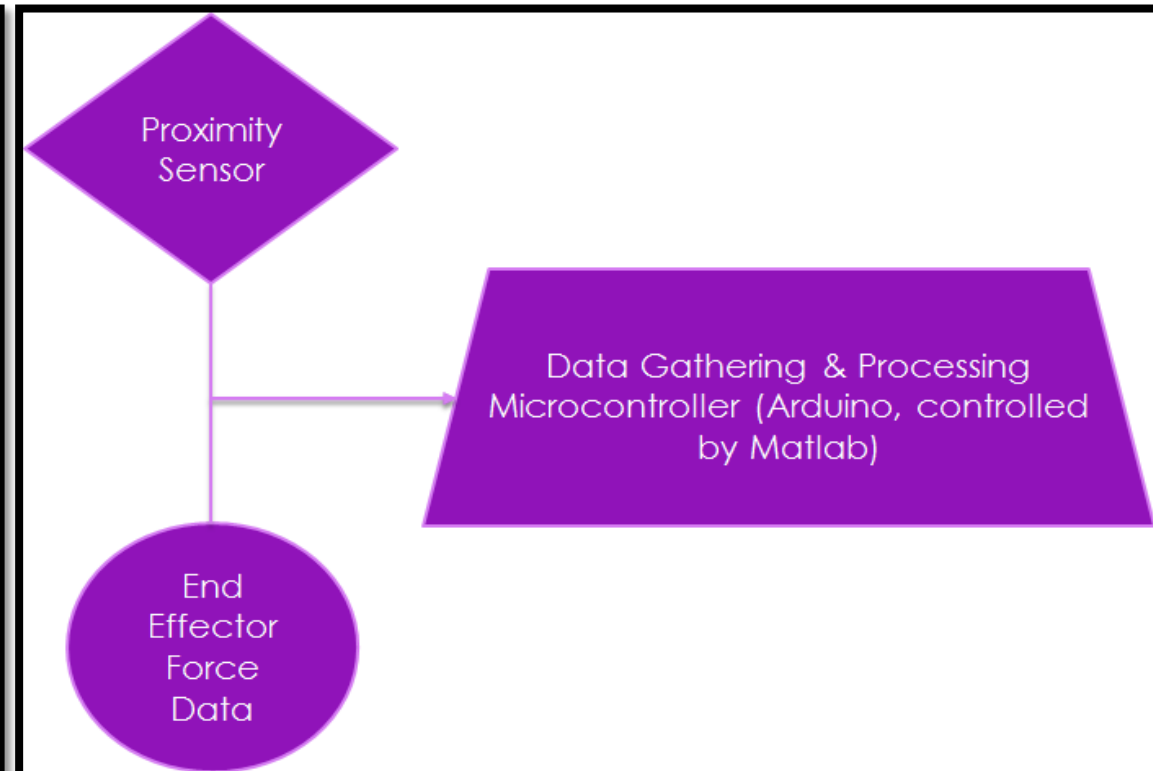
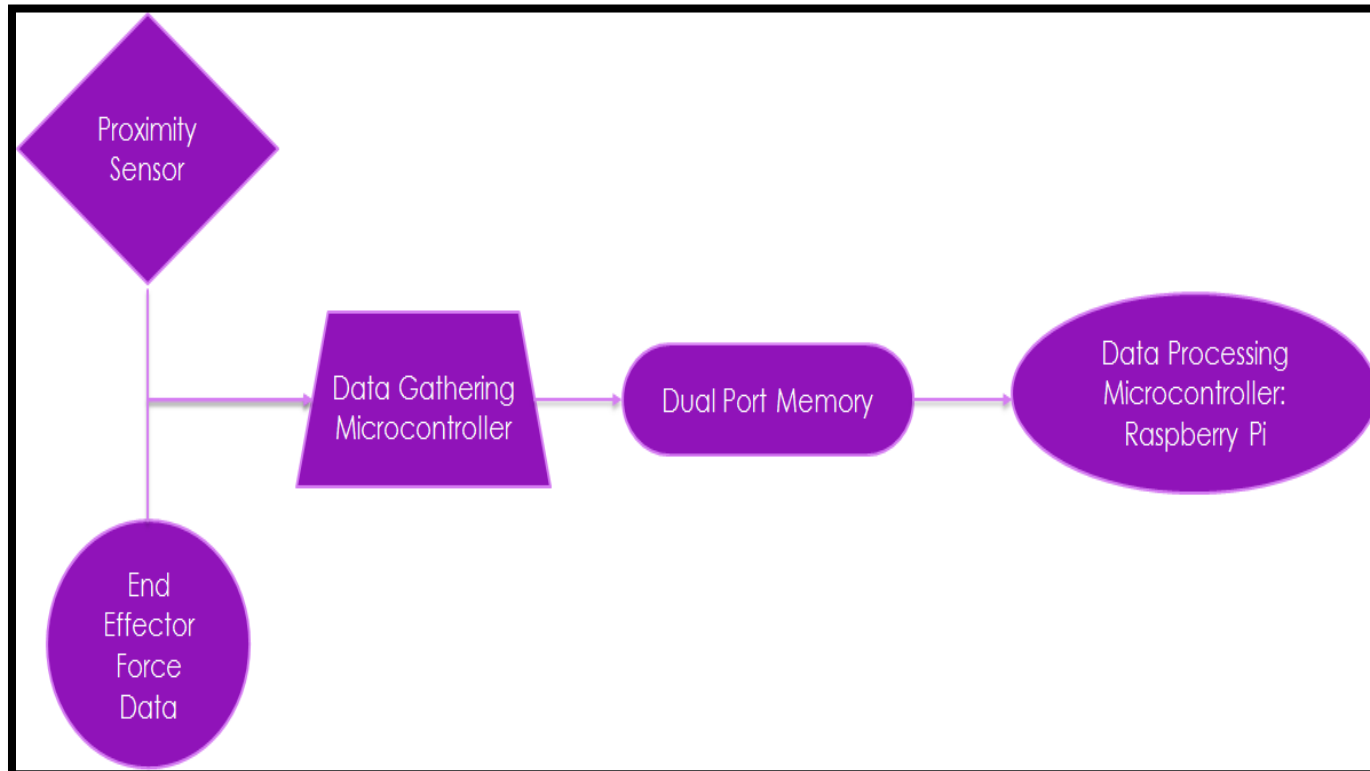



# FIRST PROTOTYPE - MECHANICAL



Technical drawing of a mechanical part showing front, side, and cross-sectional views with dimensions. The front view shows a top width of .59 and two vertical segments of .79. The side view shows a total length of 6.51 and a bottom section of 1.00. The cross-sectional view shows a top diameter of R.47 and a bottom diameter of R.98. A detail view of the top shows a diameter of .35.

PROPERTY AND CONFIDENTIALITY INFORMATION CONTAINED IN THIS DRAWING IS THE SOLE PROPERTY OF UNIVERSITY OF IDAHO. NO PART OF THIS DRAWING MAY BE REPRODUCED OR TRANSMITTED IN ANY FORM OR BY ANY MEANS WITHOUT THE WRITTEN PERMISSION OF UNIVERSITY OF IDAHO. UNIVERSITY OF IDAHO ME DEPARTMENT		DIMENSIONS ARE IN INCHES UNLESS OTHERWISE SPECIFIED	NEUROTOUCH
DATE: 11/23/2016	DESIGNER: Brooke Deans	DATE: 11/23/2016	UNIVERSITY OF IDAHO ME DEPARTMENT
BY: [Signature]	PROJECT: Neurodevice Prototype 2.8LD.PRT	SCALE: 1:2	REV: 1 OF 1

# FIRST PROTOTYPE - ELECTRICAL



# RISK ANALYSIS

## 1. Brain Injury Prevention

- LED light indicator
- Noise Alert
- Fail-Safe Mechanism

## 2. Safe for Skin Contact

- Nonharmful Materials
  - Type
  - Shape

## 3. Sterilization

- End-Effector Cover
- Autoclave parts



# RISKS/PROBLEMS

## HARDWARE

### 1. Major:

- Voltage level ported out of sensors to microcontroller
- Research sensor spot size

### 2. Minor:

- Low tolerance load sensor

## SOFTWARE

### 3. LSQCurveFit - Matlab exclusive:

- Perhaps Code own Algorithm
  1. Within Matlab or outside Matlab
  2. Will cost extra time





# KNOWN COSTS

Item	Price
Raspberry Pi 3	35.00 + shipping and tax
Arduino Uno	24.95 + shipping and tax
MicroSD card	6.79 + shipping and tax*
MicroSD card reader	17.99 + shipping and tax*
PLA Filament	Currently provided by ME dept.
Ultrasonic Sensor	On loan from Balluff
Voltage supply/display	?
Load sensor	~\$ 70
Voltage Regulator	?
Voltage Scaling Circuit	?
PCB for load sens/volt reg	?
Wires, solder, screws, etc.	?

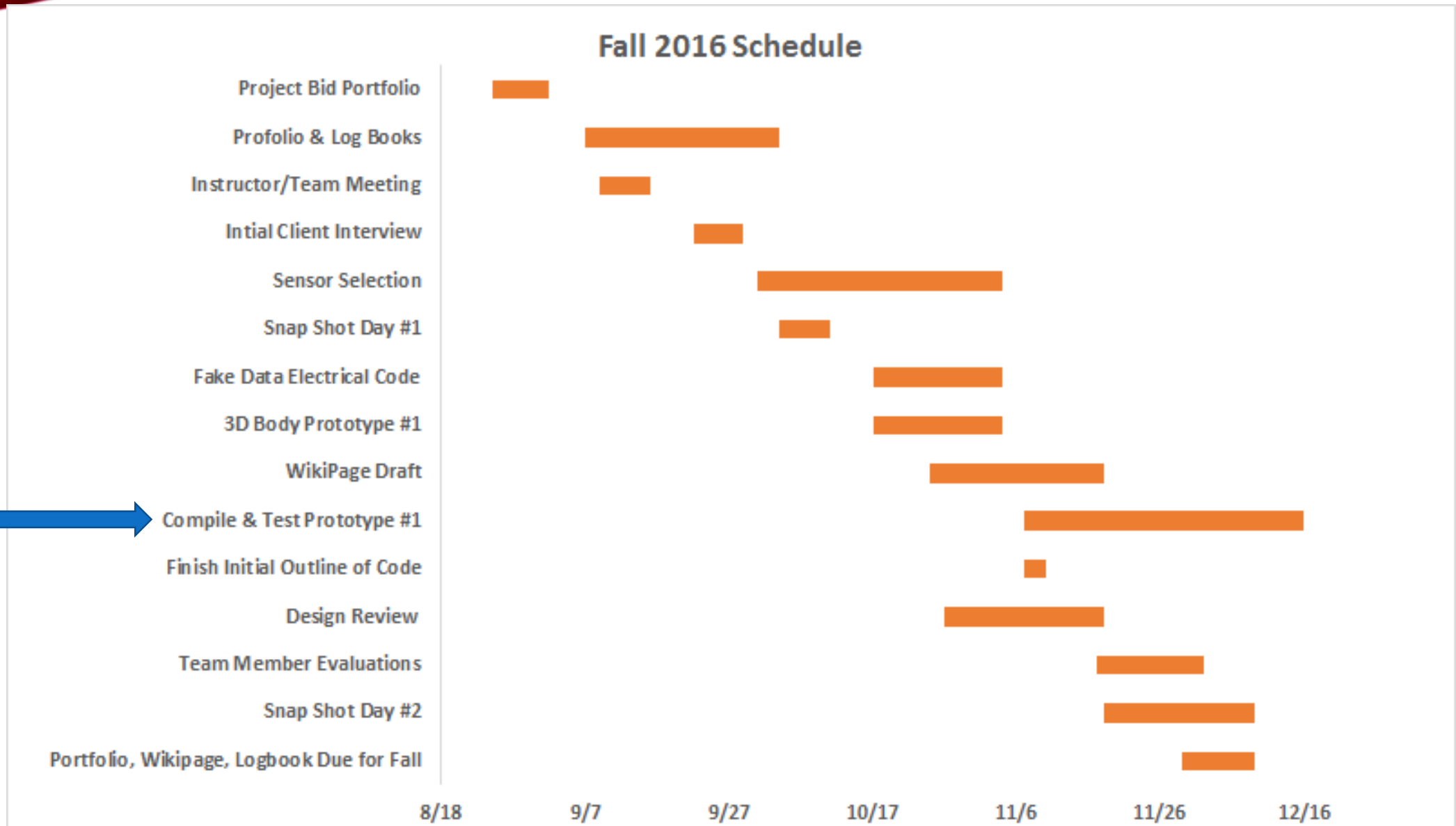

# NEXT STEPS

1. Finish 1<sup>st</sup> implementation of coding
  - Exploring Raspberry Pi as potential secondary hosting microcontroller
2. 3D model adjustments
  - Enlarging the scale
3. Future problems
  - Friction on rod in device
  - Angle compensation







# OTHER TISSUE MEASUREMENT METHODS

Tensile

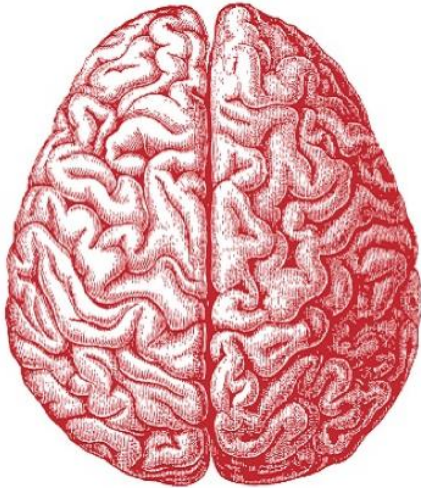
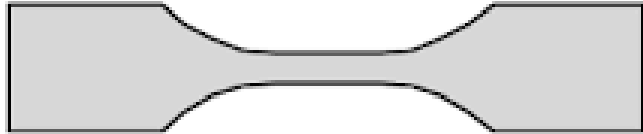

Compression

- Confined vs. Unconfined

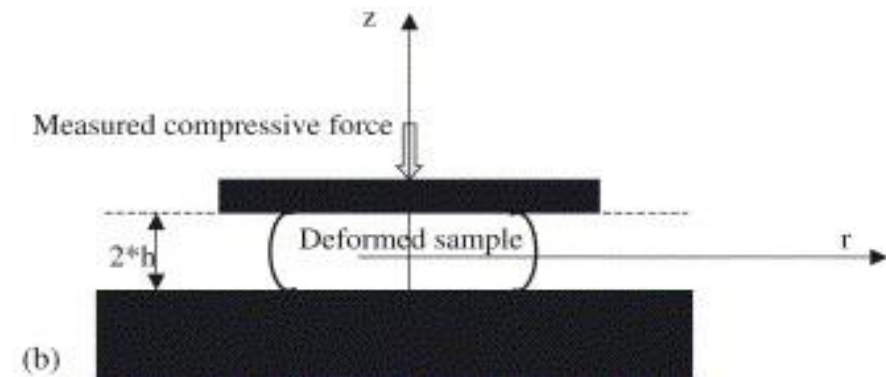
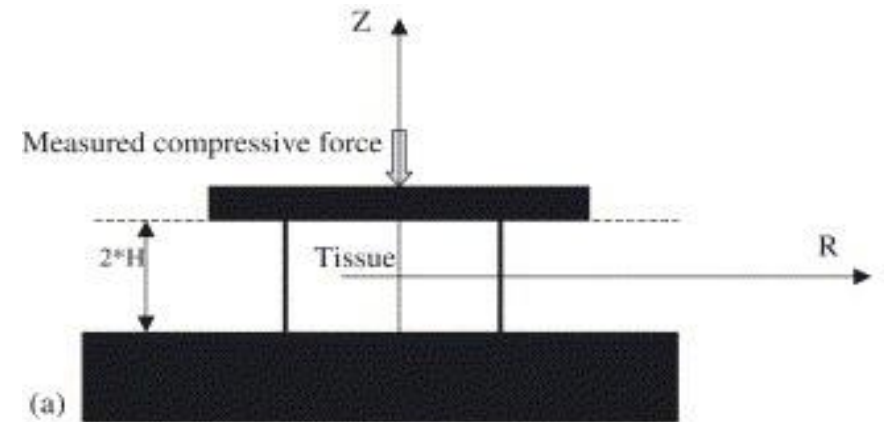

# EARLY DESIGN CONCEPT IN VITRO METHOD: AFM

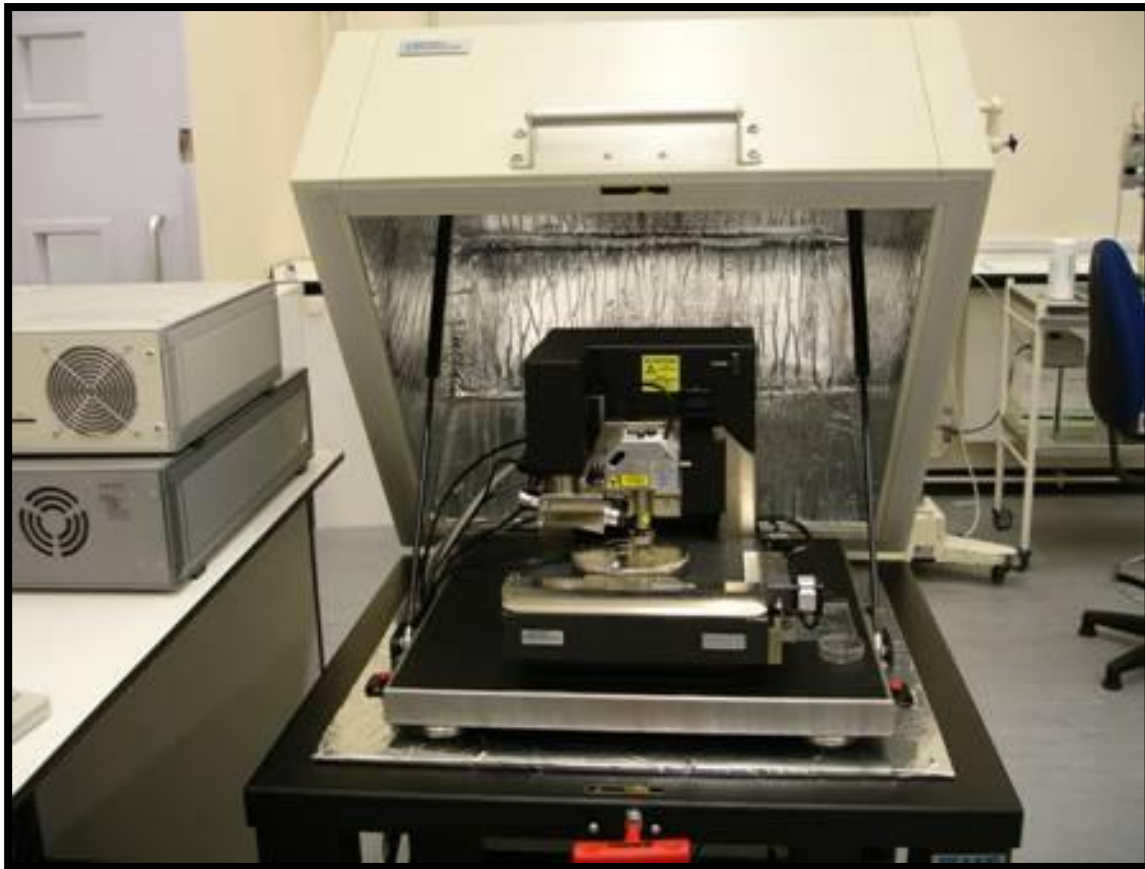

Detector



Laser beam

Cantilever

Sample

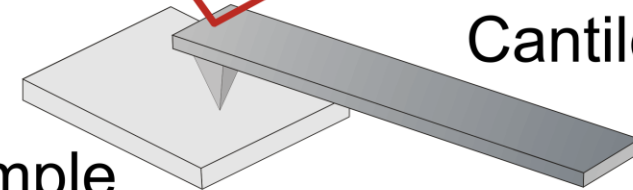

# OVERALL ELEC. DESIGN: REV 0.0

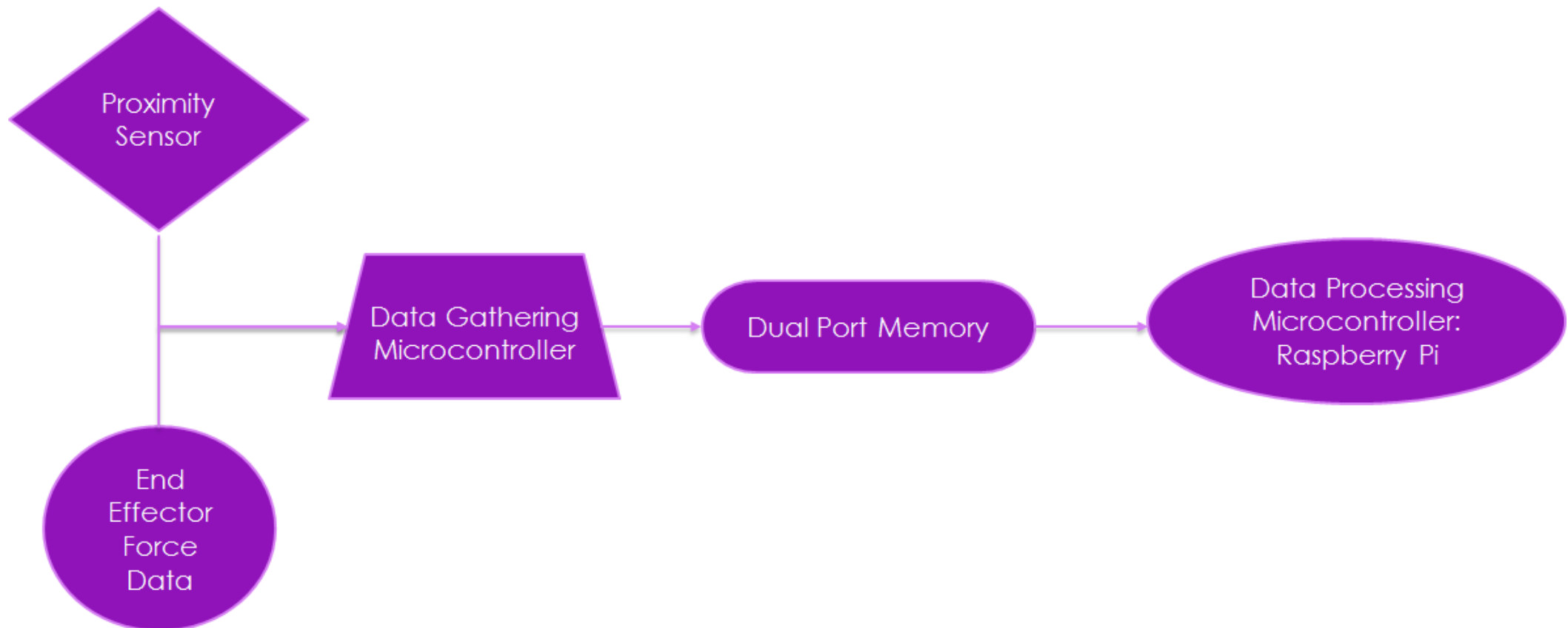

# OVERALL ELEC. DESIGN: REV. 1.0

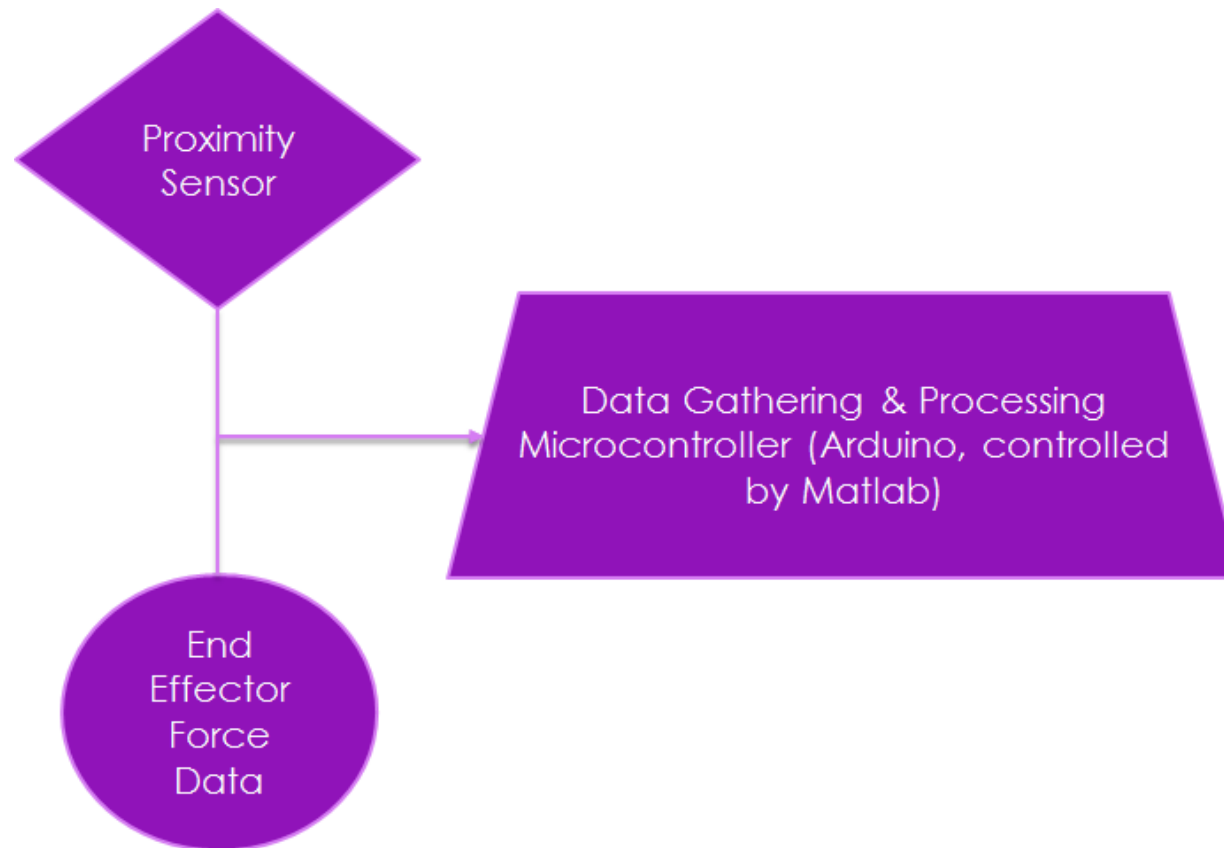



# OVERALL ELEC. DESIGN: REV 1.1.1

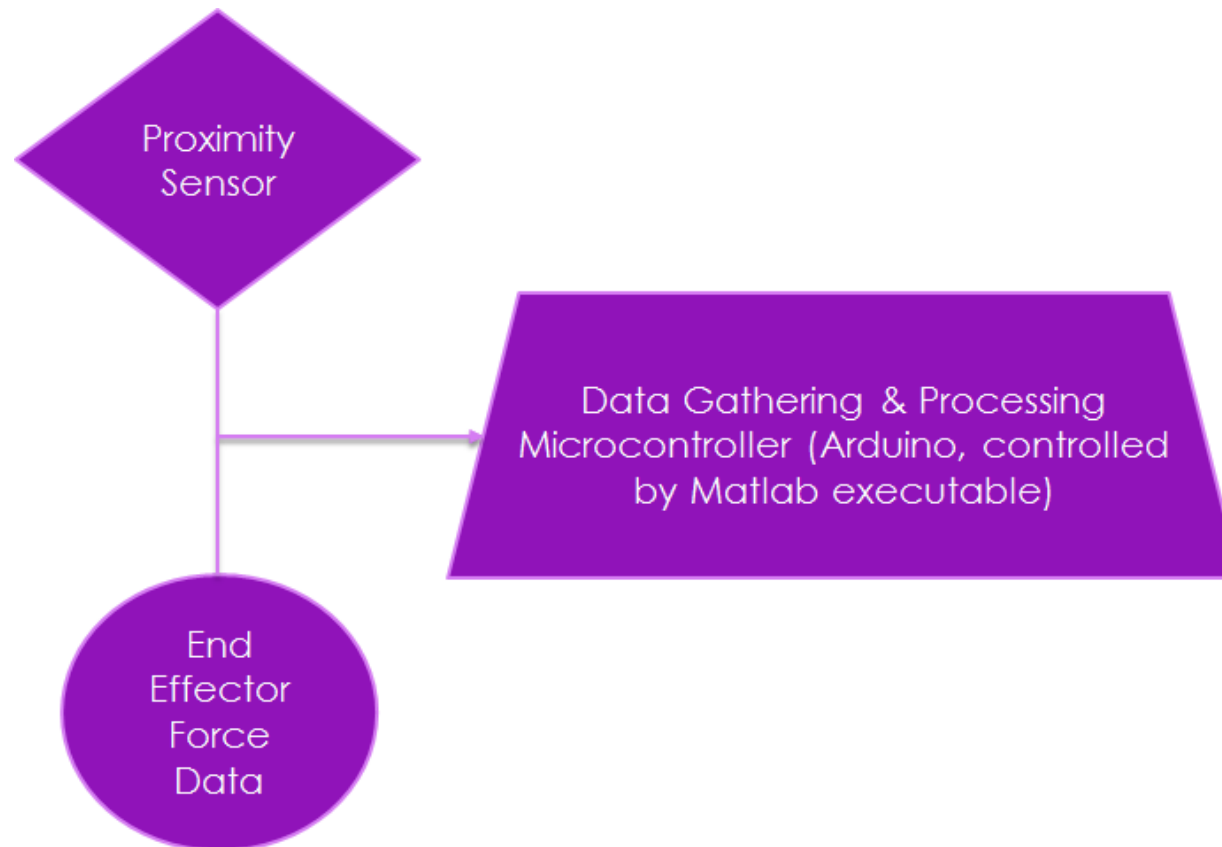

# OVERALL ELEC. DESIGN: REV. 1.1.2

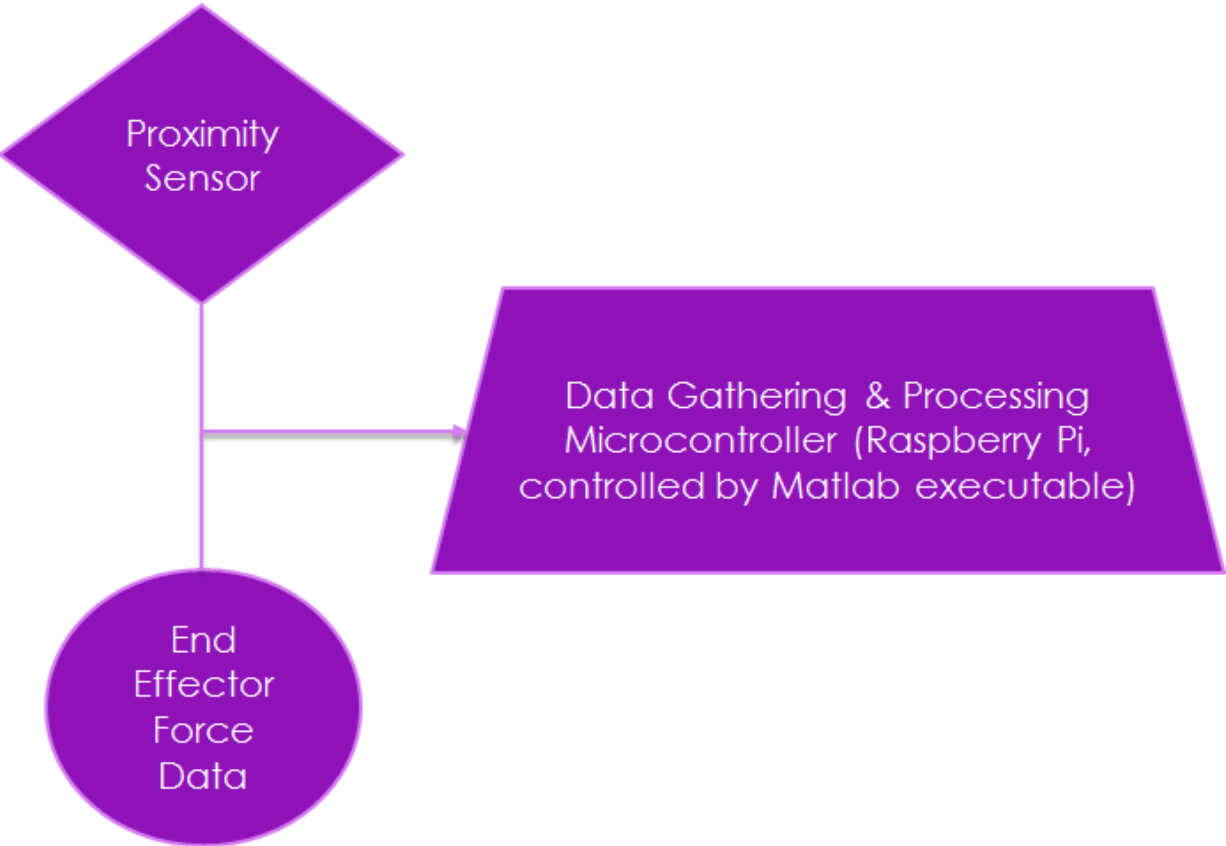

# OVERALL ELEC. DESIGN: REV. 1.1.3

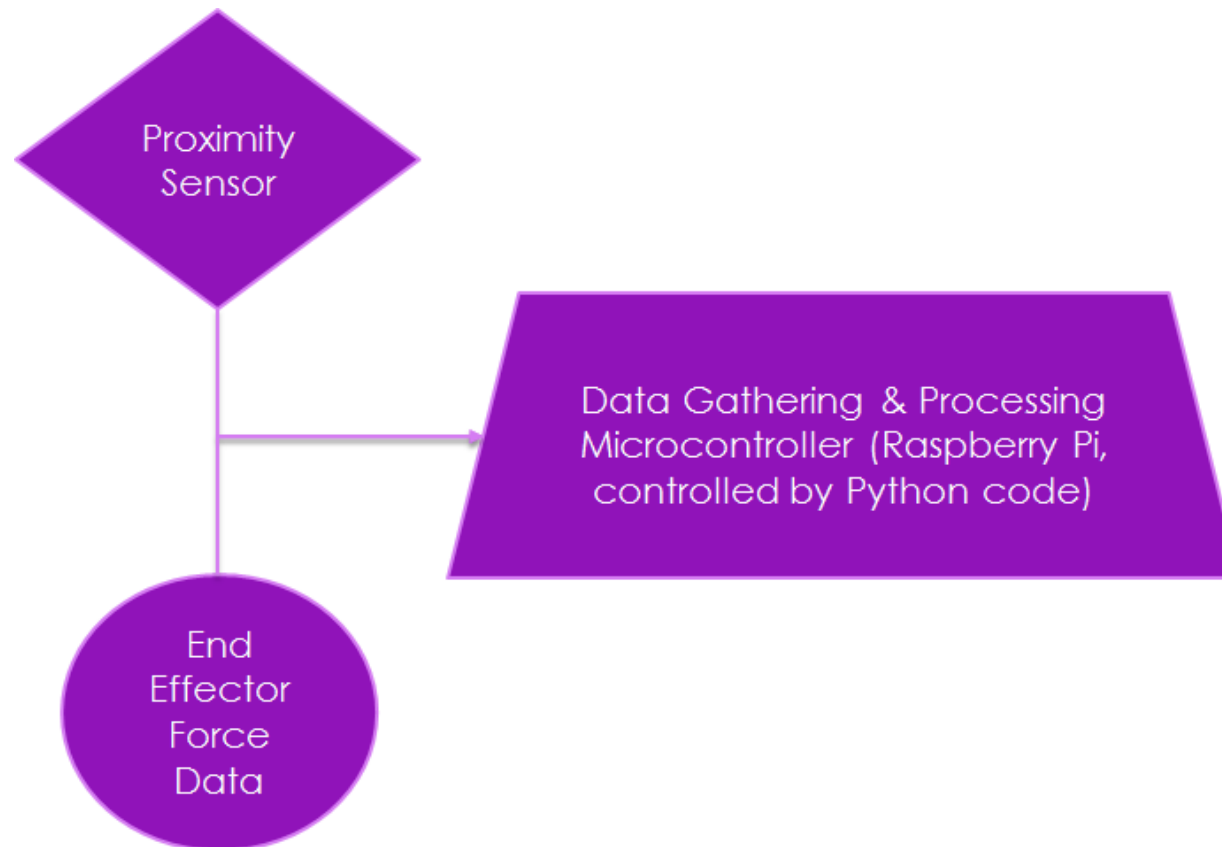

# OVERALL ELEC. DESIGN: REV. 1.1.4

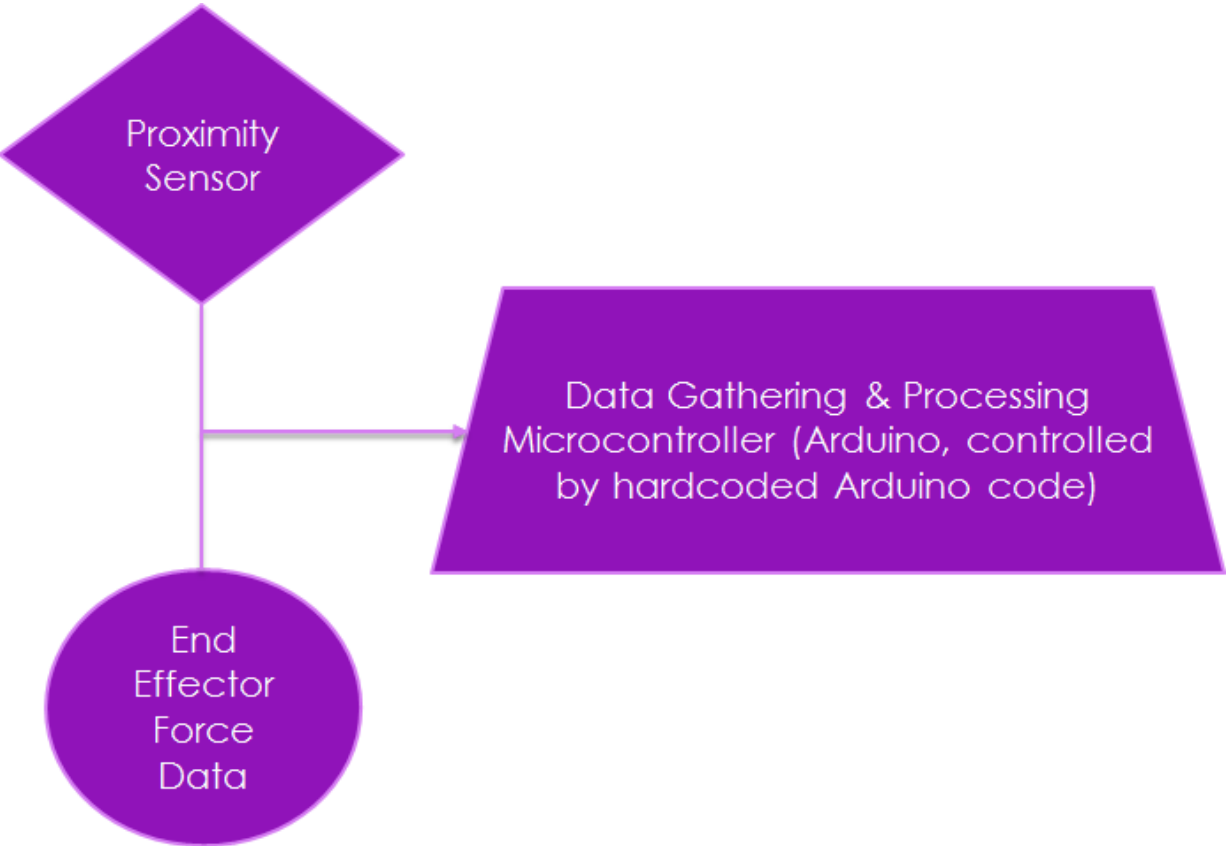



# HARDWARE/SOFTWARE TIMELINE:

Date	Activities
Nov	First revision of apparatus, Arduino first proof of concept, test platform for limitations on speed, testing of sensors, develop PCB for lin reg (if needed) and force sensor, accommodate in body design
Dec	-: Research different sensors, see Nov. +: Apply Matlab code to device, test methods of transferring data over distance from sensors to microcontroller
Jan	-: See Dec. +: Begin porting code to Python/Arduino (become less dependent on Matlab), will need to be researched for more effective/efficient porting
Feb	-: Research alternative microcontroller to host connection, understand different coding approaches to handling data +: Finish last touches/documentation for Rev 1.0, prepare for design and development of Rev 2.0
Mar	-: See Jan and Feb +: Increasing efficiency of algorithm, add information display method(LCD screen, seven segment display, etc.)
Apr	Looking for more compact electrical apparatus, higher precision, finishing touches on coding algorithm efficiency for Rev 2.0 of device
May	Finished project, work on presentation/posterboard, etc.