

# ME 430 EXPERIMENTS

## Heat Pipe and Solar Tracker

BradLee Speirs, Dan Cox, Jens Christiansen

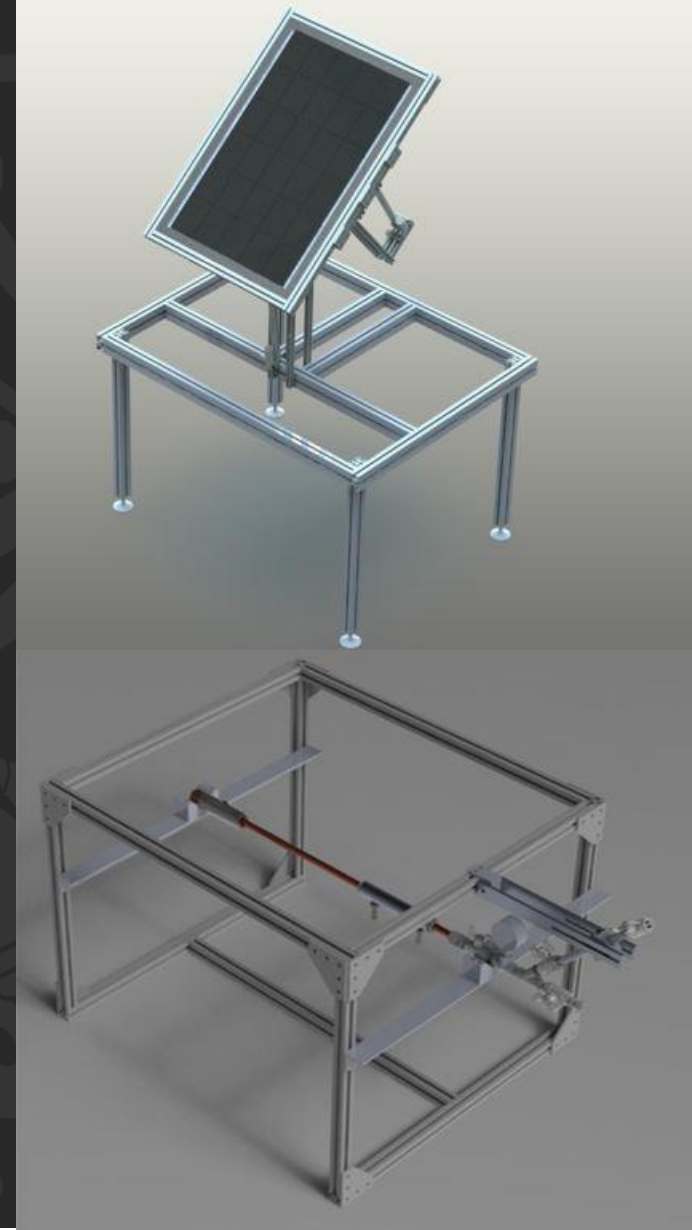
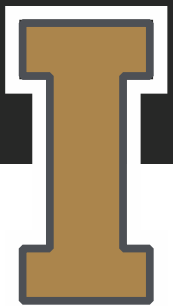

# ME 430 GOAL

- ME 430 purpose is to engage students in an industry like experiment.
- Dr. Kumar has assigned us to build a heat pipe and solar tracker experiments for the class.

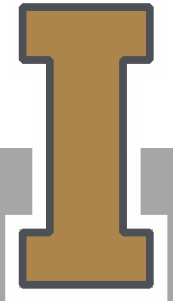

# SOLAR TRACKER OVERVIEW

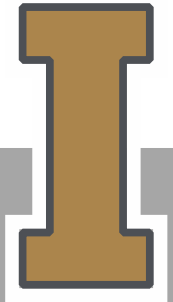

# HEAT PIPE SPECIFICATIONS

- Ability to change heat pipe and mesh (must)
- Measure heat distribution (must)
- Compatible with LabVIEW (must)
- Measure heat Flux (strong should)
- Test vertically and horizontally (want)
- Cost under \$1200 (want)

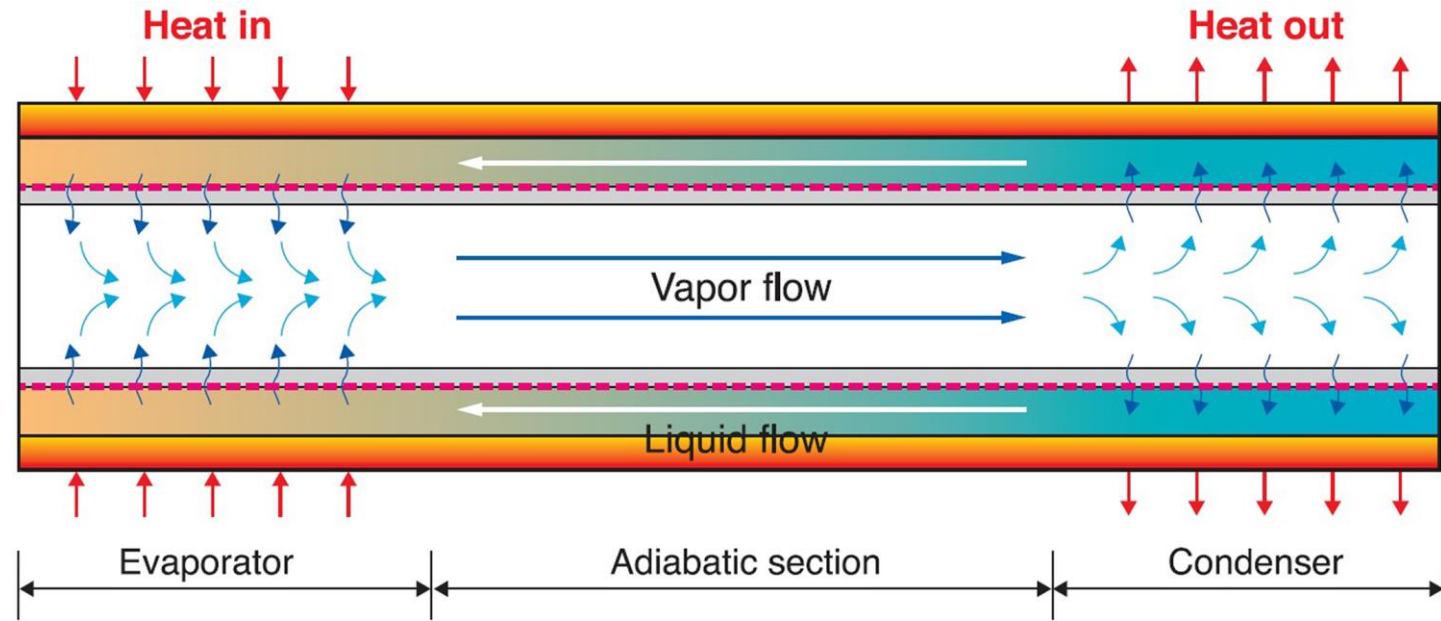

# DESIGN EVOLUTION

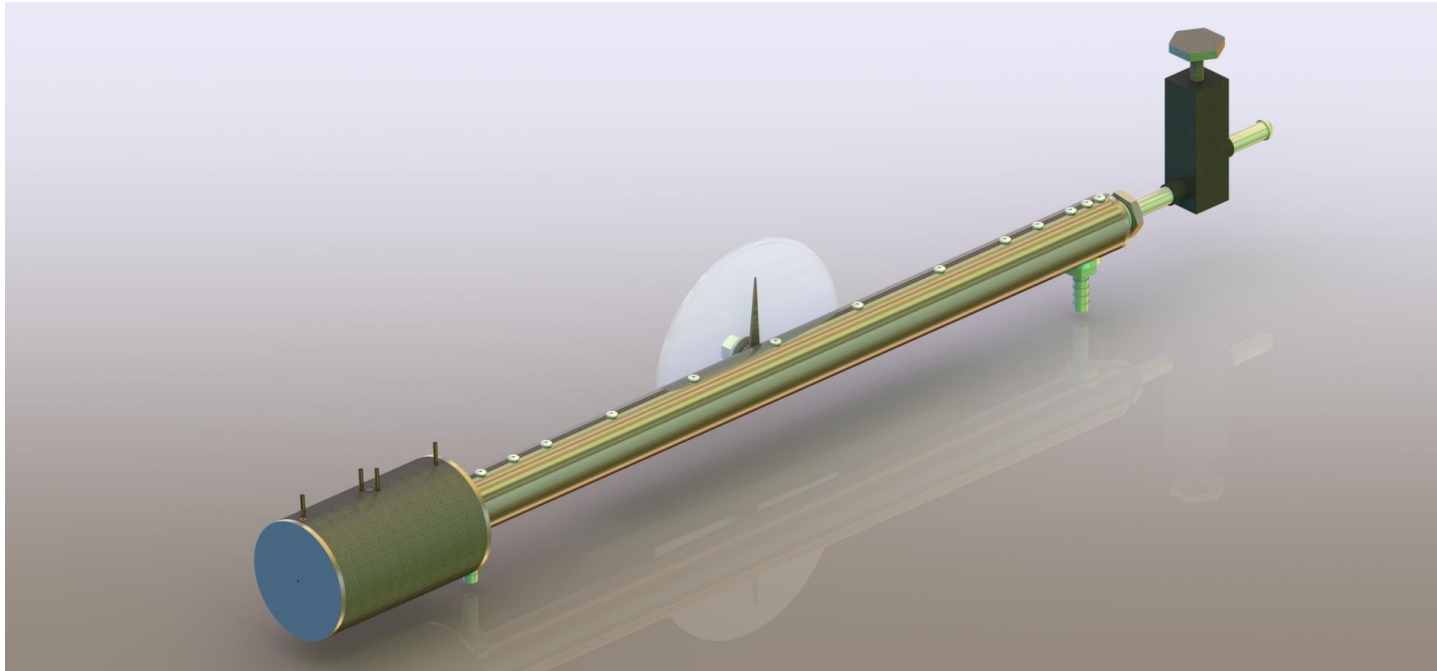

Legacy Design



Revised Design

# SYSTEM DIAGRAM

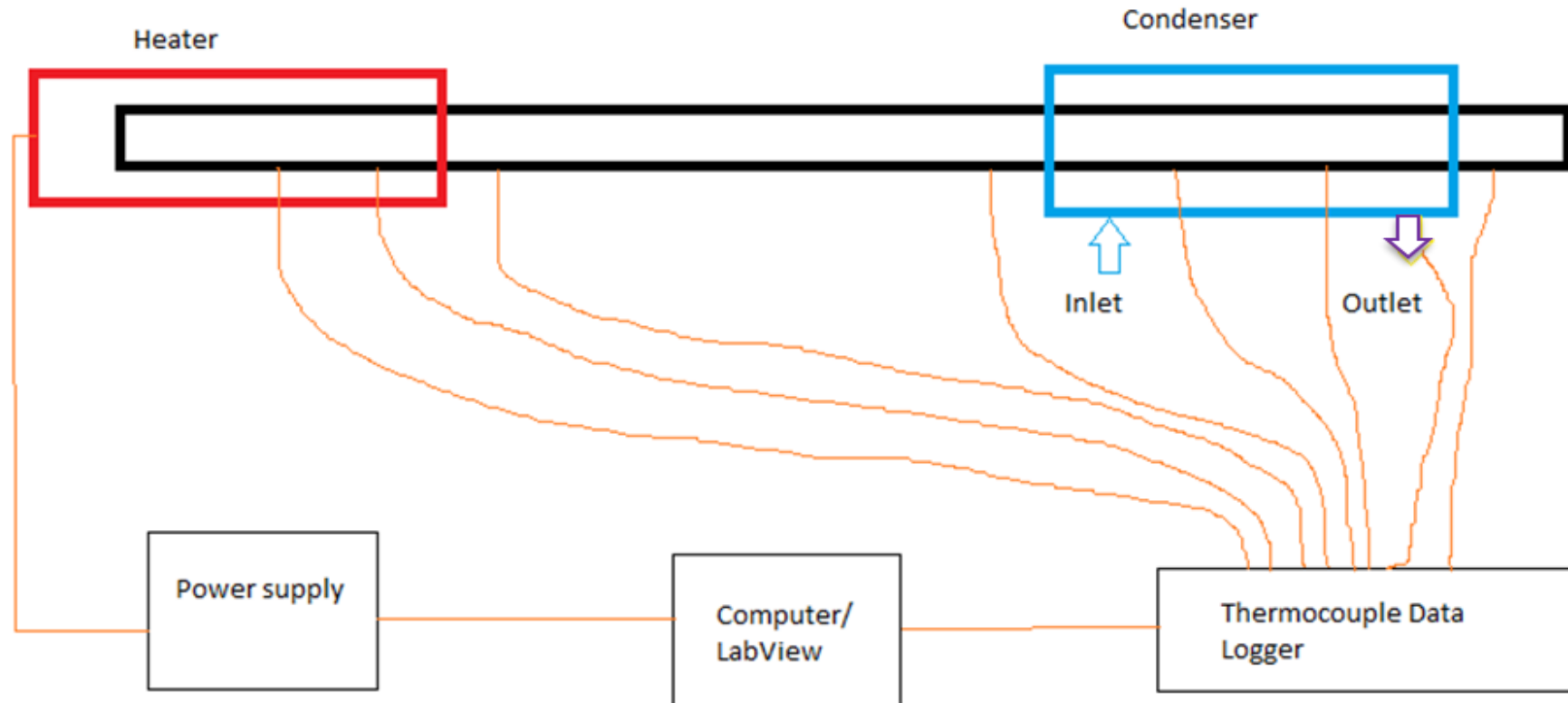

# FINAL PACKAGING



Full System

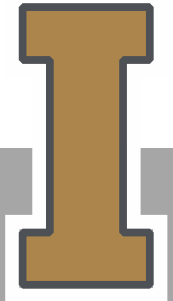

# LABVIEW INTERFACE

**Power Supply**

VISA resource name: COM4

Control Mode(1:Remote): Remote 1

Enable Output (T: Enable): Enable

**Serial Configuration**

Baud Rate (9600): 9600

Parity(0:none): None 0

Data Bits(8): 8

Flow Control(None): None 0

Stop Bits(1.0): 1.0 10

Function(0:Voltage): Voltage 0 Manual Range(0.00): 72.00 Unit(V): V 0

Measurement Function(0:Voltage): Voltage 0 Voltage: 51.6290

Measurement Function(0:Current): Current 1 Current: 1.29811

Measurement Function(0:Power): Power 2 Power: 67.018

**Equations**

T_1	P	Q_Power	Q_Condenser
0	0	0	0
T_2	V	Average T_Heater	m_dot
0	19.75	0	0.01947
T_3	t	Average T_Condenser	Q_loss
0	30	0	0
T_4	For Calculation	h	R
0	STOP	NaN	NaN

**Temperature**

For Temperature Reading: STOP

Mains Frequency: 50 Hz

Units: C°

Ch # 1	Ch # 2	Ch # 3	Ch # 4	Ch # 5	Ch # 6	Ch # 7	Ch # 8
Type # 1	Type # 2	Type # 3	Type # 4	Type # 5	Type # 6	Type # 7	Type # 8
J	J	J	J	J	J	J	J
47.47	48.51	42.45	41.88	21.05	22.06	22.25	22.18

Close and Exit



# LABVIEW RESULTS

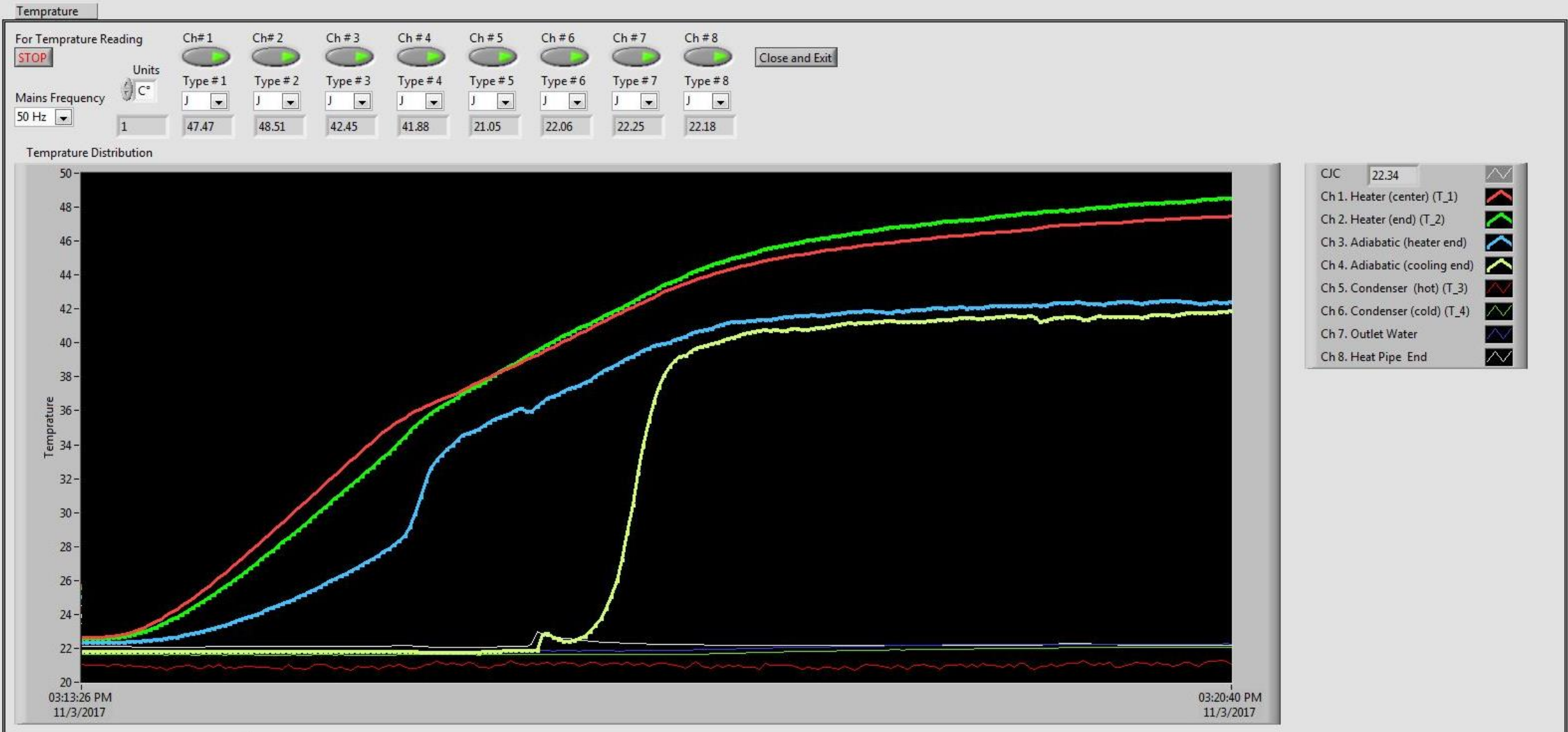

Heat pipe experiment with water at about 27 in Hg Vacuum in a grooved heat pipe.

# HEAT PIPE PERFORMANCE

- Heat Loss due to conduction and convection
- Not in a complete vacuum

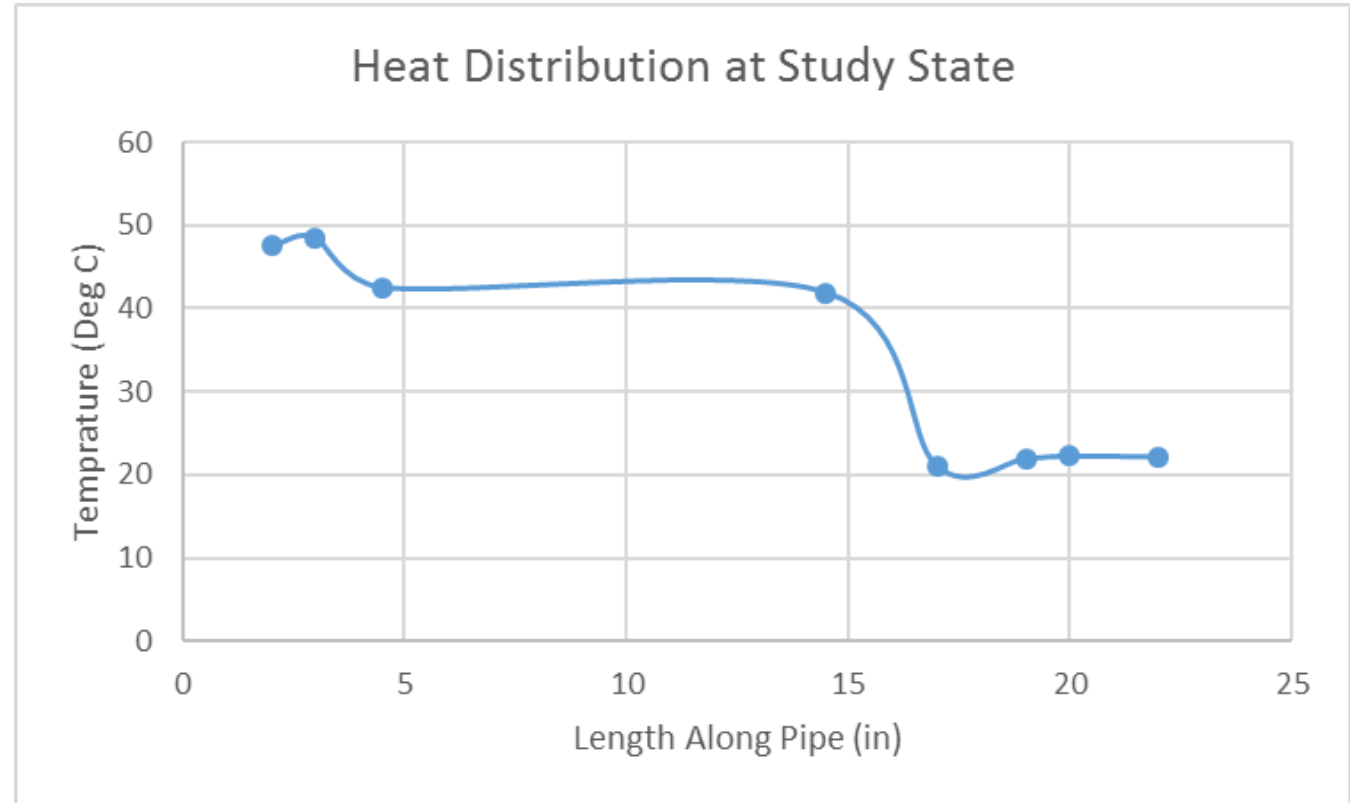

# HEAT PIPE LESSONS LEARNED

- Order heats with standard thread/diameter sizes.
- Special fittings are needed to hold a vacuum.
- The condenser section has a lot of leakage pathways.

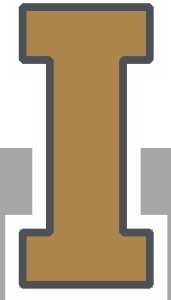

# QUESTIONS?

