

# INTER-TURN FAULT DETECTION FOR AIR-CORE REACTORS

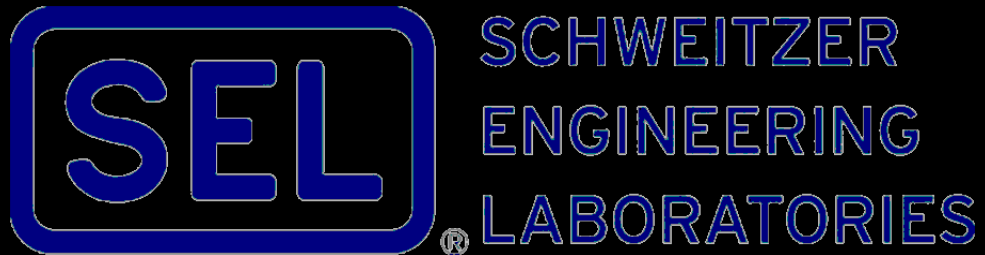

Lyn England, Andrew Hoth, Justin Jeter, Tanner Mort

# Deliverables

- ▣ Small Scale Air-Core Reactor Model
  - Include single test phase
  - Ability for future use and testing with model power system
  
- ▣ RTDS Model
  - Does it match?
    - ▣ Small Scale Model, ATP
  - Transferability to 230KV system at Noxon
  
- ▣ Proof of Concept Coil
  - Wind with parallel layers for validation

# Project Challenges:

- ▣ Balancing reactor phases
- ▣ Winding precise test coils
- ▣ X/R Ratio
- ▣ Solid, non-magnetic mounting frame
- ▣ Ease of use for testing

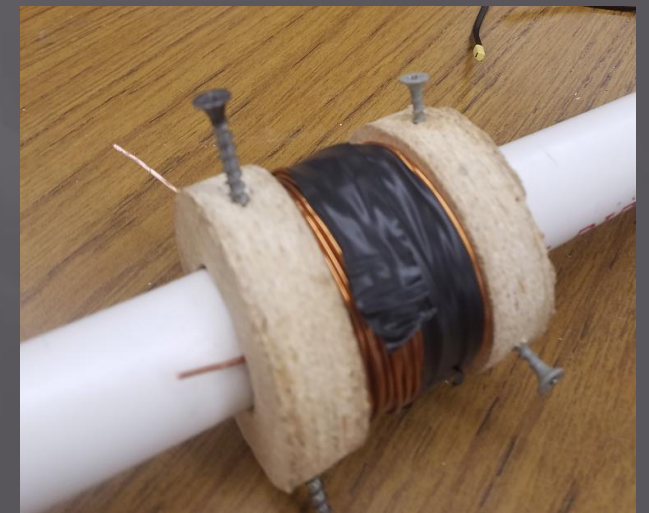

# Small-Scale Model Final Specs

- ▣ 120Vac Phase to Ground
- ▣ Less than 5A Phase to Ground
- ▣ 60 Hz
- ▣ 80mH per phase
- ▣ X/R of 3.5
- ▣ 15AWG Wire
- ▣ Multiple points for fault testing

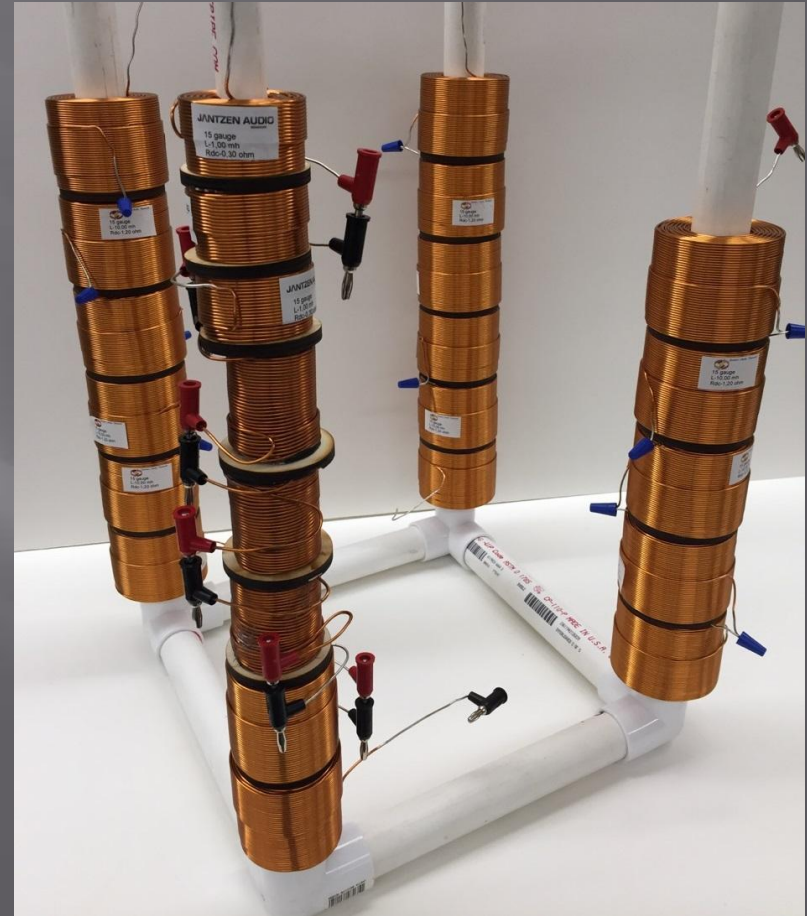

# RTDS Model:

- ▣ Built to model small-scale system and Avista's system at Noxon
- ▣ Matched reactor values and X/R ratios
- ▣ Similar behavior found across all models

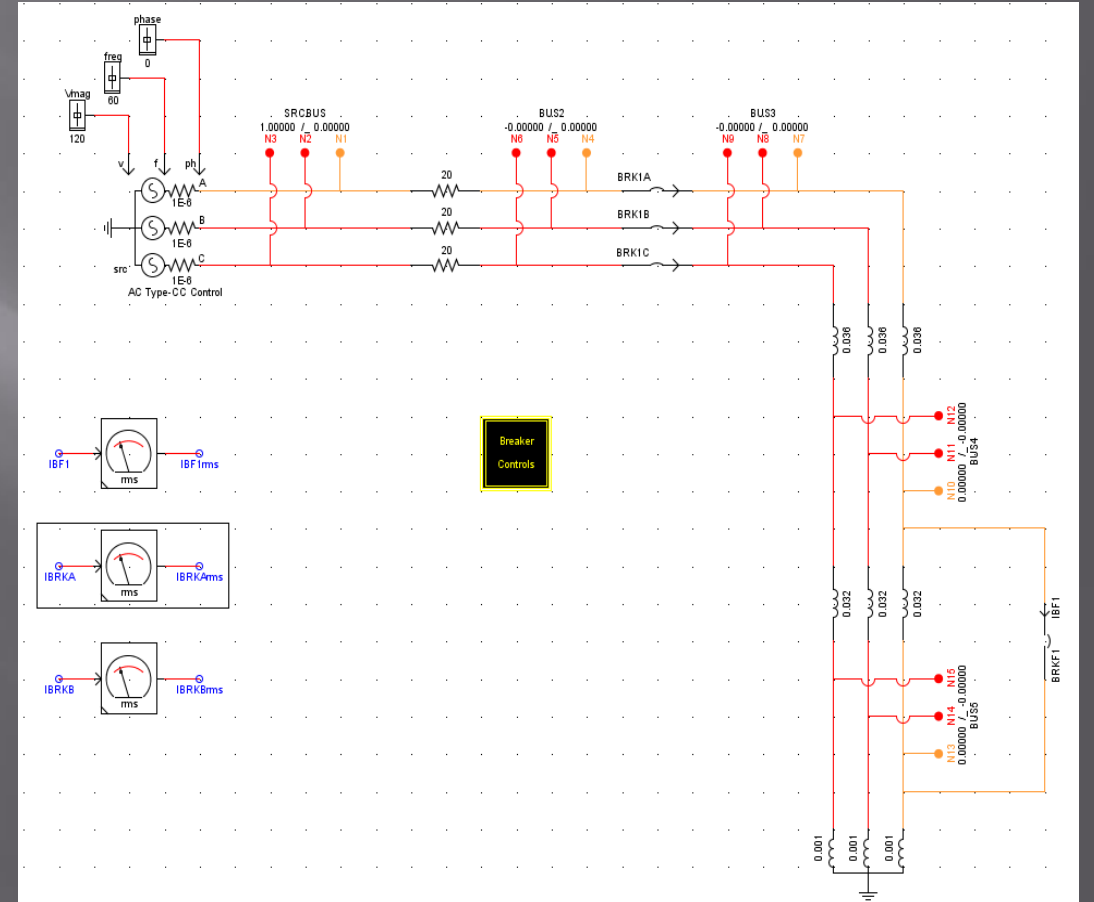

RTDS Circuit

# Simulation Comparisons:

120V RTDS MODEL WITH 12.5% FAULT:

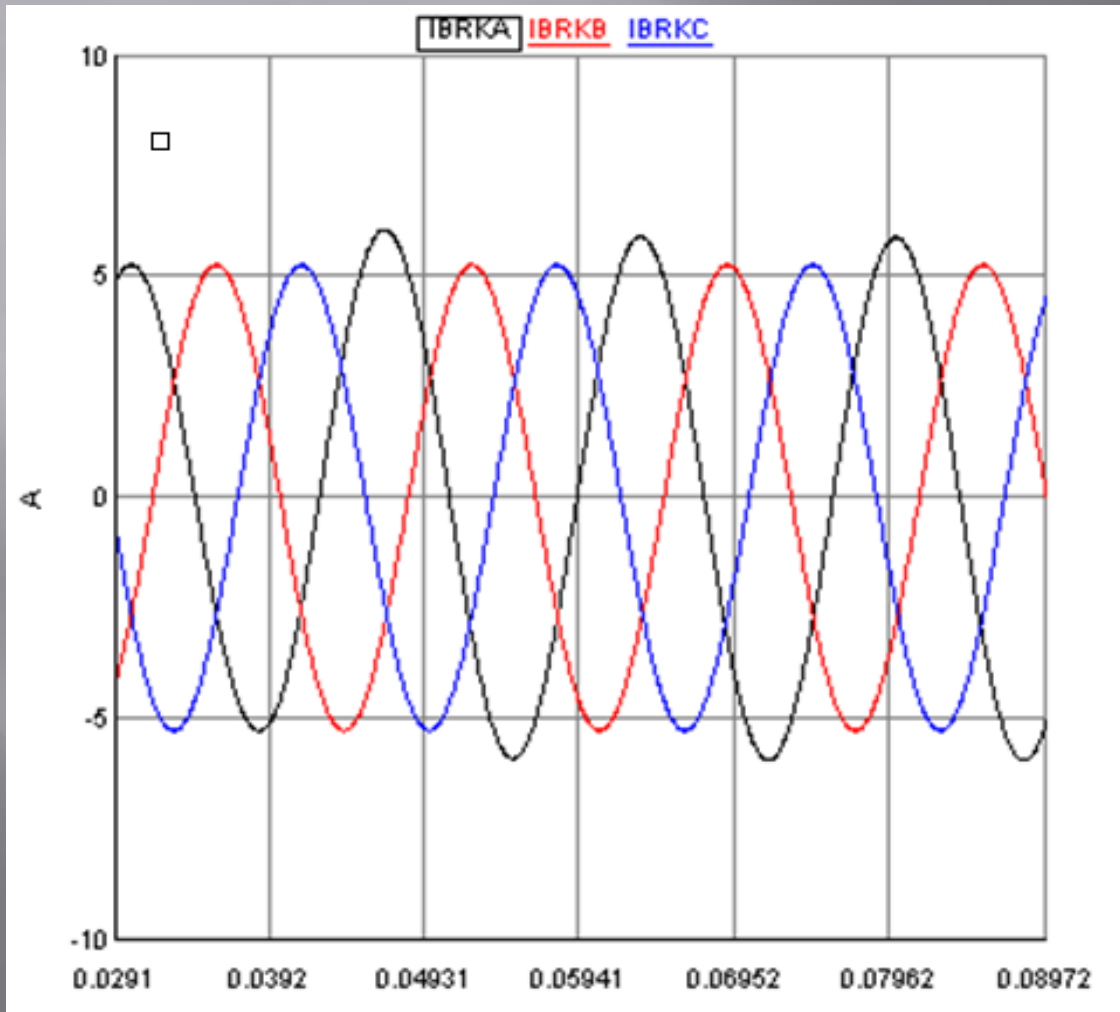

120V Small-Scale Model with 6.25% Fault:

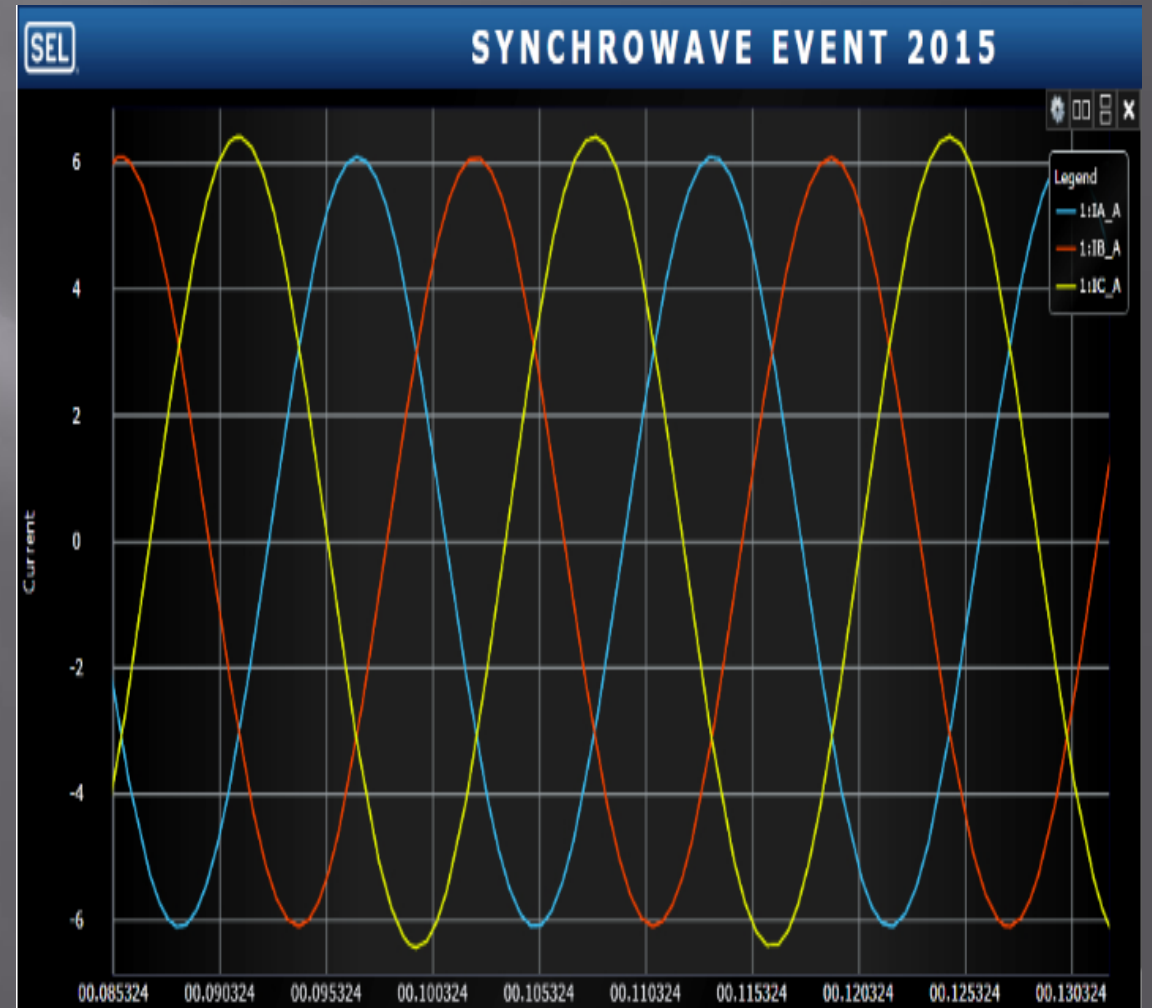

# 230KV RTDS

Energizing 230KV RTDS Model

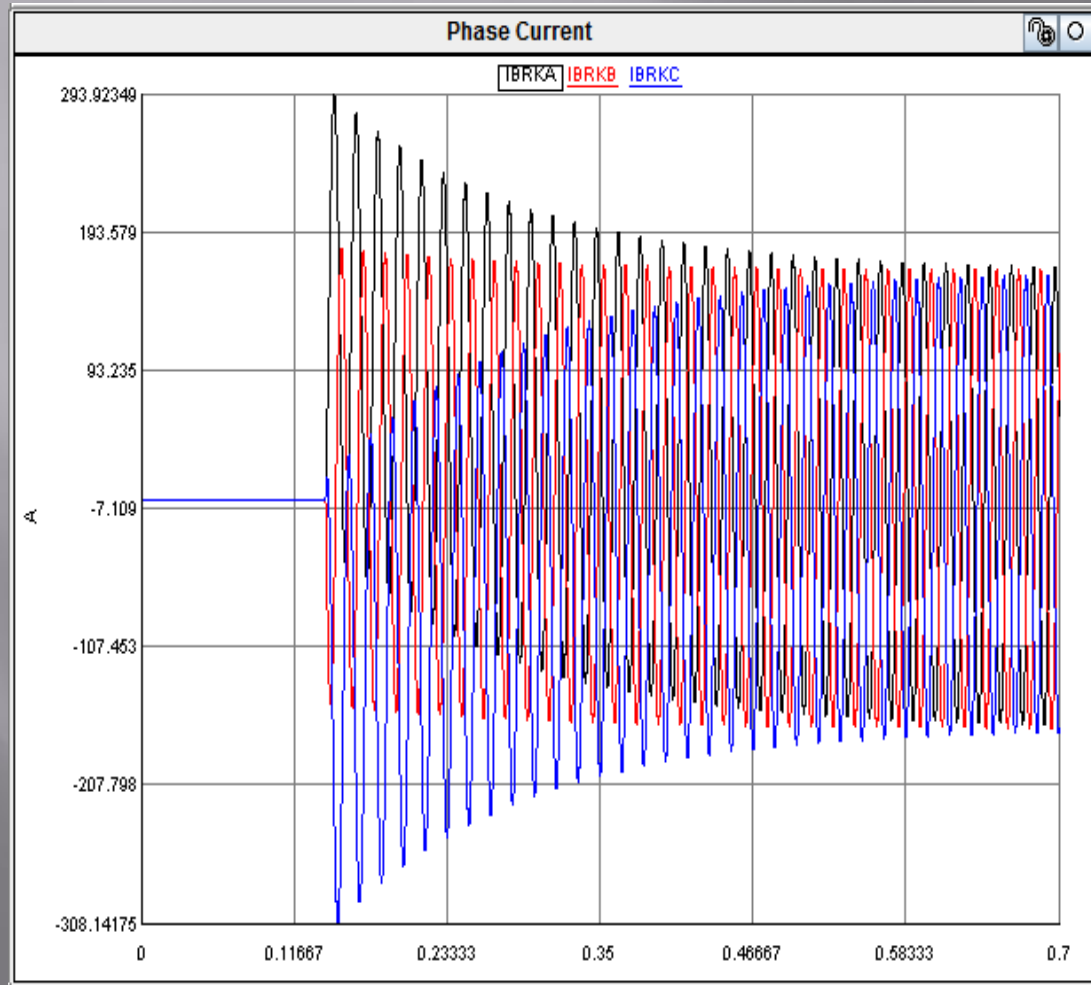

230KV RTDS MODEL WITH 8.3% FAULT:

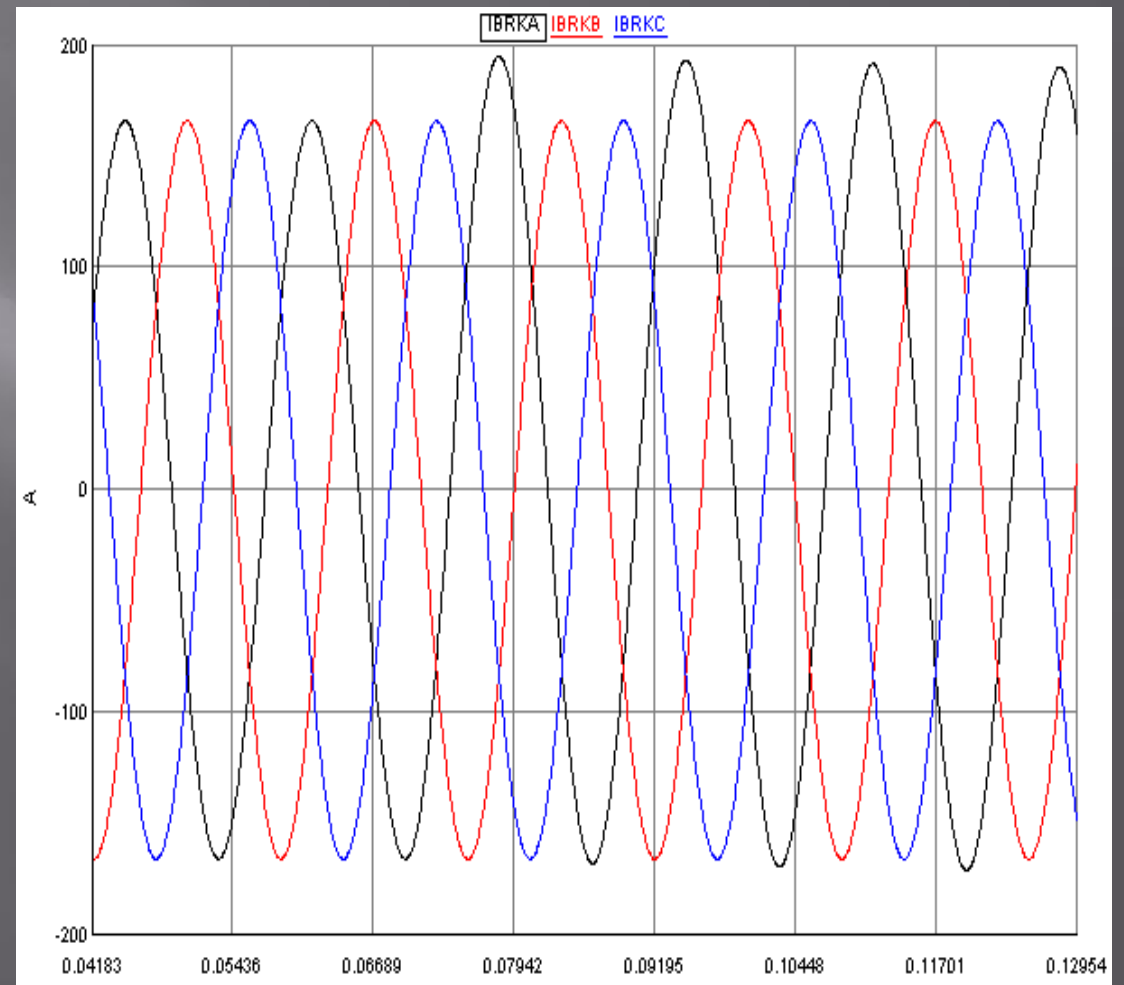

# Proof of Concept Coil

- ▣ Multi-Layer parallel coil built to model the reactor windings at Noxon
- ▣ Asad was able to use this for proving measurements and calculations
- ▣ Proved to be successful in Asad's testing

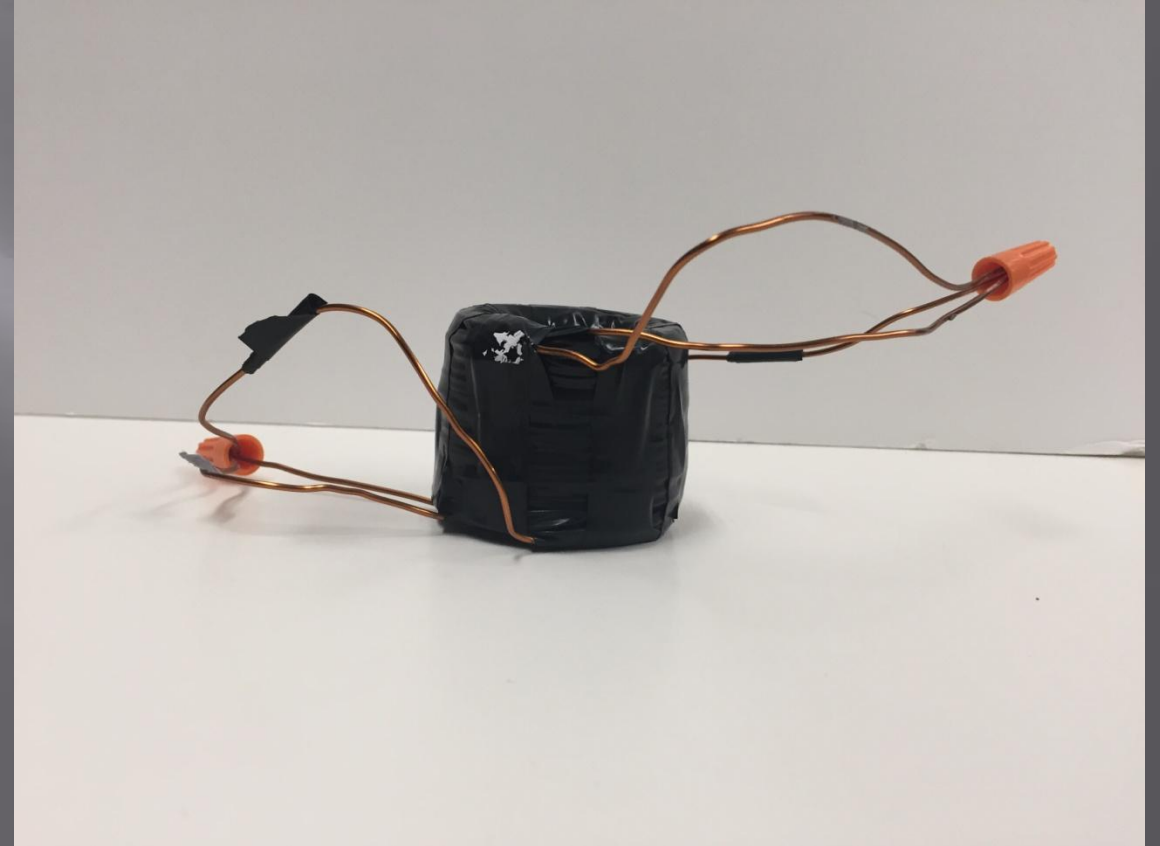



# Budget

Expenditures	Cost
Trip to Noxon, MT	\$331.57
Test coil (Janzen)	\$45.81
Test coil (MadiSound)	\$149.33
Bulk order of coils for test system	\$1,222.83
Bulk copper wire order (self wound coils)	\$245.23
Test coil purchase (1mH, 2mH, 3.3mH coils)	\$130.07
Tools/Mounting stand supplies	\$139.13
Total Budget:	\$4,800
Total Expenses:	\$2,263.97
Amount remaining in Budget:	\$2,536.03

Questions???