

Pocket Microscope Slide Scanner

Team Apollo

Michael Camerino (BE)

Jeff Crawford (CS)

Archana Dahal (BE)

Isaac Riggs (CS)

Nico Yensen (BE)

Sponsor

Children's Cancer Therapy
Development Institute

Advisor

Dev Shrestha



Value Proposition

According to the World Health Organization, 70% of deaths caused by cancer worldwide occur in developing countries. The overwhelming majority of these cases are diagnosed as late-stage terminal cancers. Access to affordable cancer diagnostics equipment would surely help alleviate this calamity. One common cancer diagnostics method is analysis of relevant tissue samples under a microscope. Currently, there is no **highly portable, rugged, or practical solution** to this, much less an **affordable** one. We aim to create a device that will be able to address these limitations of devices and take an extremely **high-resolution image of a sample of tissue**. This image will then be sent to our client's machine learning grid that can identify cancerous tissue samples to 97% accuracy. The image will also be sent to specialized physicians that can confirm the diagnosis. It is our belief that with this device, the suffering to humanity caused by cancer can be lessened.

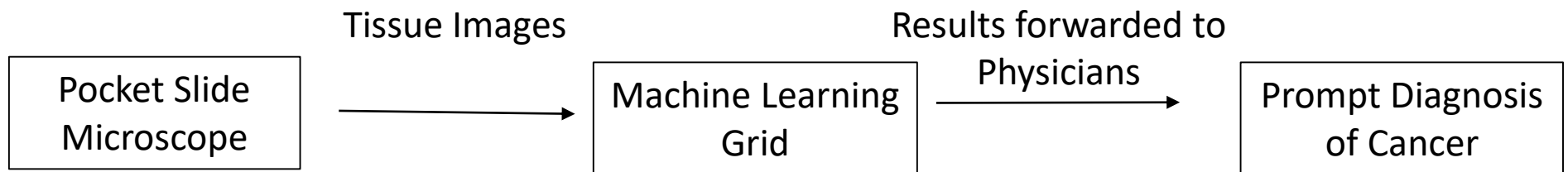

Product Requirements

Cost Requirement

- **Device will cost < \$1000**

User Interface Requirements

- Minimal buttons
- **Interface device via Apollo app support**
- Live view of slide
- Coarse and fine adjustments to adjust field

Storage and Battery Requirements

- MicroSD card support
- Utilization on phone storage
- **150 mm x 80 mm x 30 mm**
- **Minimum of 8000 acquisitions per charge cycle**

Optics and Camera Requirements

- **20x effective zoom**
- **0.25 - 0.5 μm /pixel resolution**
- **large format imaging capability (up to 1cm²)**
- LED light source (5600K)
- Auto white-balance (optional)
- Auto-focus

Networking Requirements

- Wi-Fi (802.11 b/g/n compliant)
- Bluetooth 4.1 compliant
- 4G LTE when paired with smartphone

Design Concept B

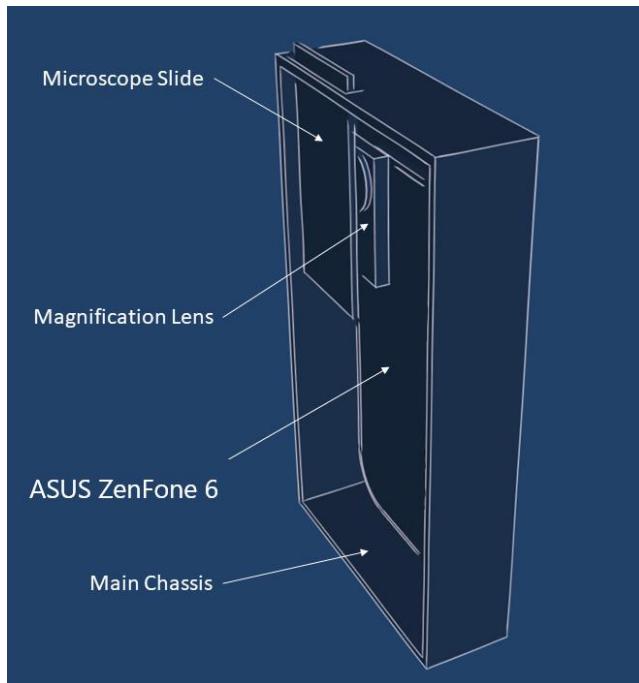

Highlights:

- Integrated as a rugged phone case
- Magnification lens is available as a consumer product
- Utilizes phone for image capture, processing, and stitching
- Also requires a phone app for device control, stitching

Testing:

- Attachment of magnification lens to ZenFone 6
- Usage of achromatic light condenser
- Resulting resolution of $0.65\mu\text{m}/\text{px}$
- Addition of 2x magnification lens yielded no viable image

$$0.65\mu\text{m}/\text{px} > 0.5\mu\text{m}/\text{px}$$

The development of this design has been discontinued

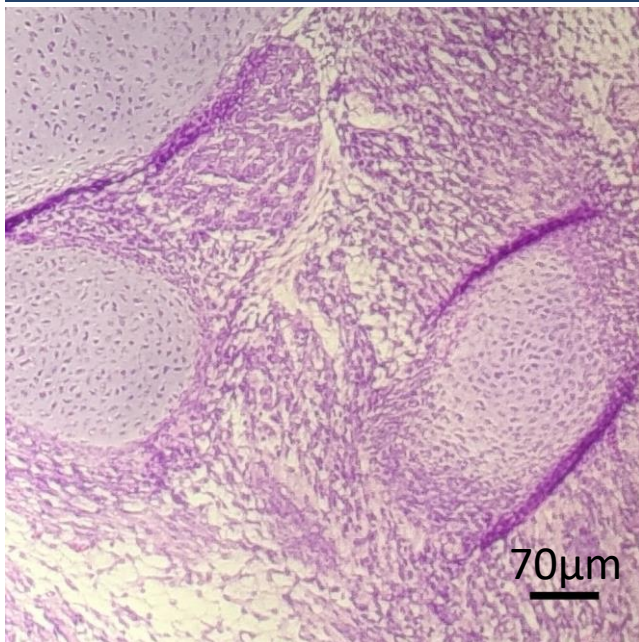

Design Concept A

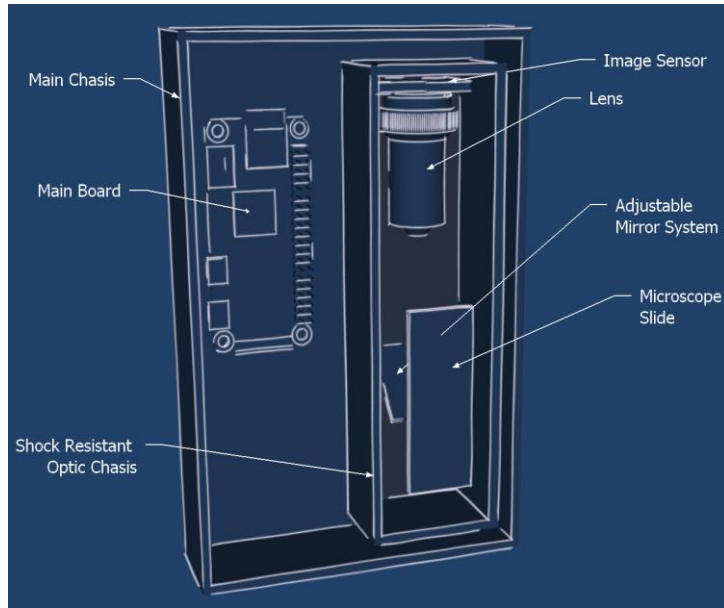

Highlights:

- Standalone and optimized device
- Utilizes a Raspberry Pi 4 to process and distribute image to phone
- RPi4 Compatible CMOS image sensor
- Bluetooth connectivity to phone
- Phone app for device control and image stitching
- Rugged Enclosure

Testing:

- Apparatus construction:
 - Stage
 - Pi-cam adapter, objective lens fitting
 - Achromatic condenser
- Excellent imaging results: $0.11\mu\text{m}/\text{px}$

$$0.11\mu\text{m}/\text{px} < 0.5\mu\text{m}/\text{px}$$

The development of this design is now the primary focus

3D Models for Prototyping

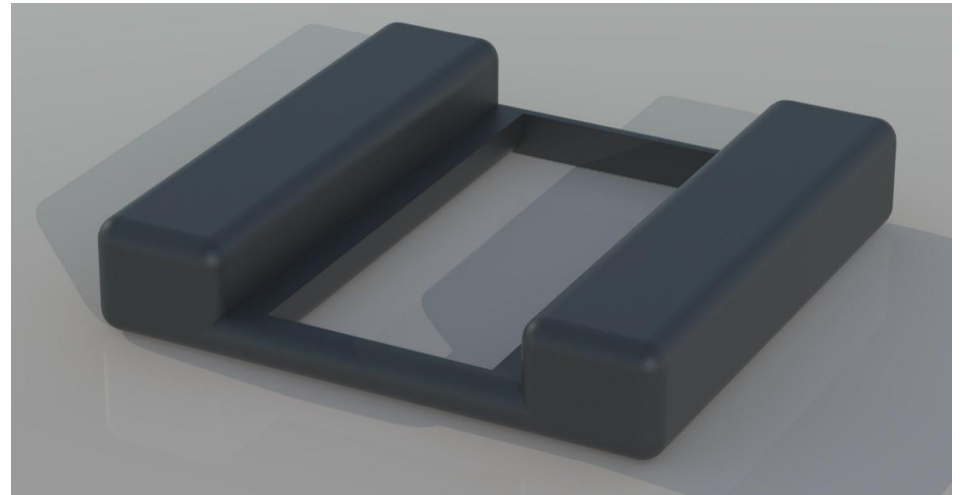
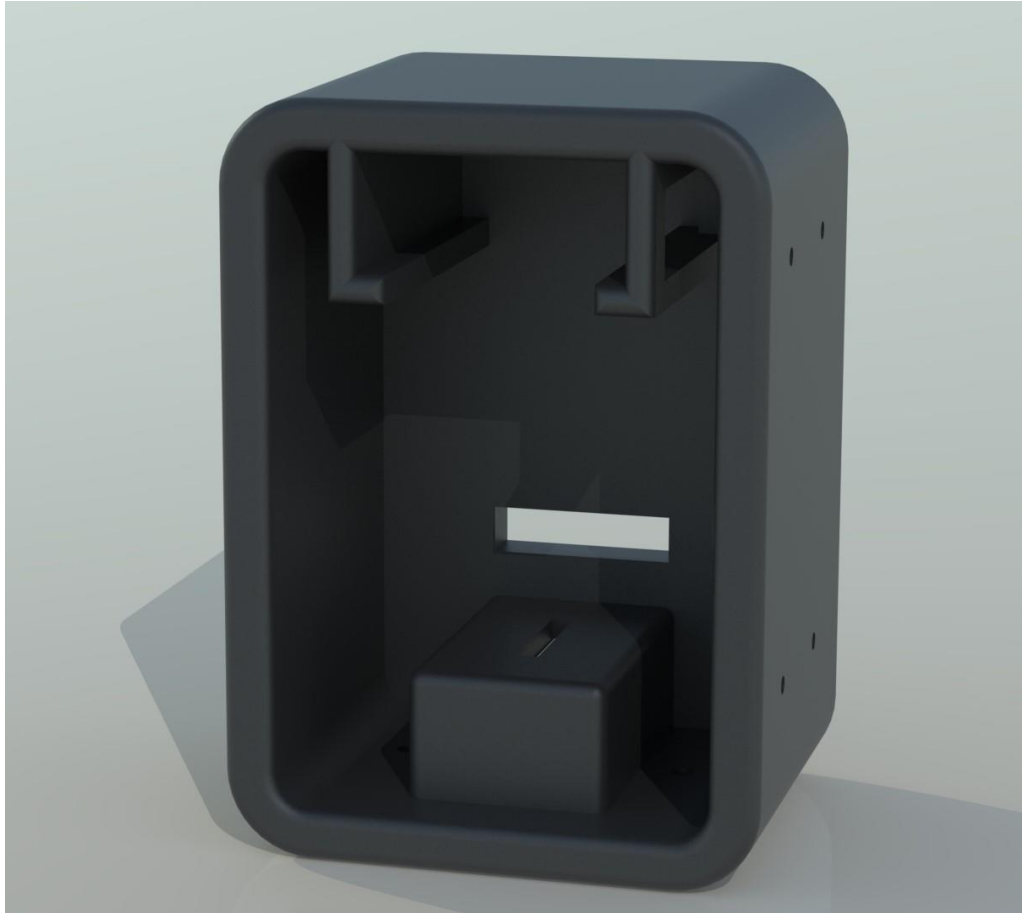

Optics Enclosure - Version 0.4

Design Image Results Comparison

Design Concept A: 0.11 $\mu\text{m}/\text{px}$

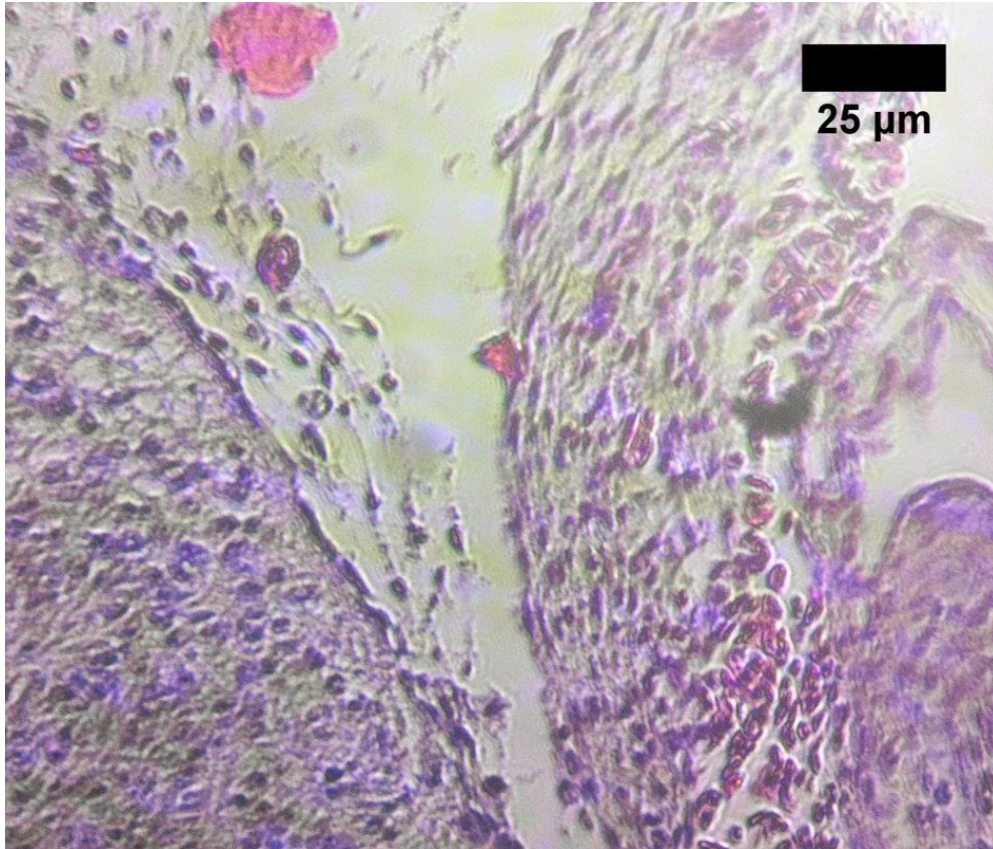

Design Concept B: 0.65 $\mu\text{m}/\text{px}$

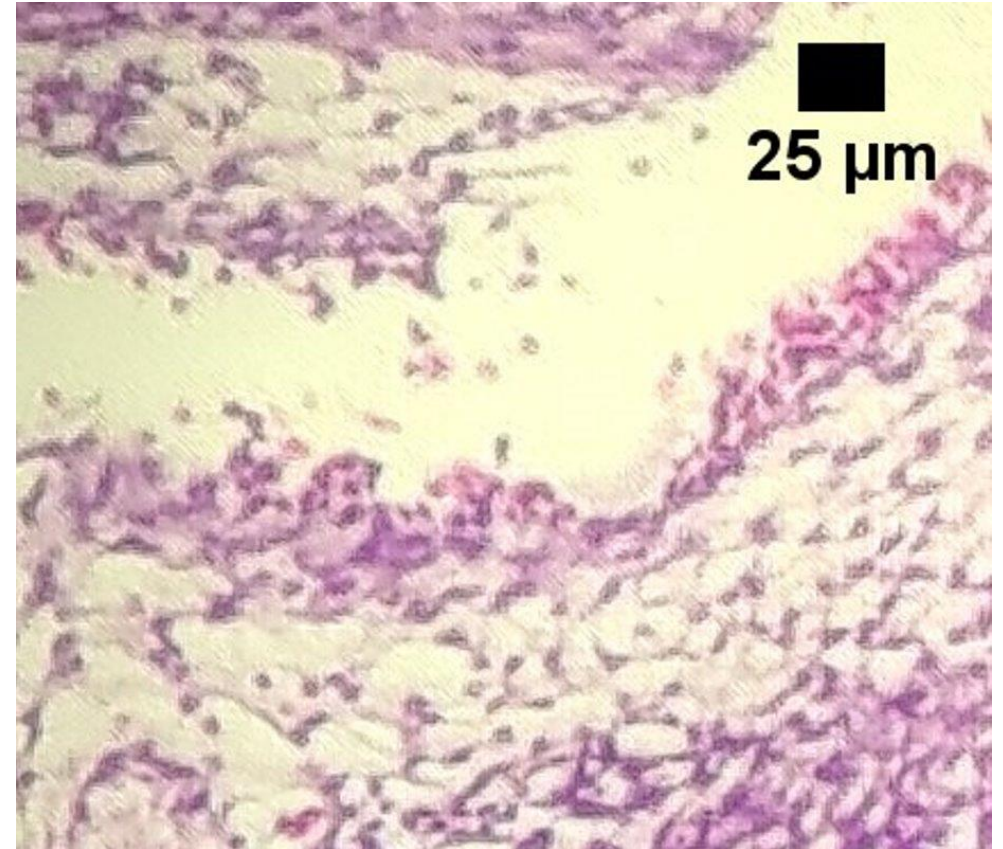

Future Plan

- Software Development
 - Linear Image Stitching
- Stage Design
 - Movement in XYZ direction
 - Lead Screw and Step motor
- Optics System
 - Monochromatic Light Source

