

General Converter Report

Team Kill-A-Watt

Abdencio Sanchez (sanc8689@vandals.uidaho.edu)

Jake Querubin (quer1587@vandals.uidaho.edu)

Advisers: Dr. Herbert Hess, Amrit Dahal

Table of Contents

<i>EXECUTIVE SUMMARY</i>	3
<i>I. BACKGROUND</i>	3
<i>II. PROBLEM DEFINITION</i>	3
<i>III. PROJECT PLAN</i>	4
<i>IV. CONCEPTS CONSIDERED</i>	4
<i>V. CONCEPT SELECTION</i>	5
<i>VI. PROJECT RE-SCOPE 1</i>	5
<i>VII. PROJECT RE-SCOPE 2</i>	5
<i>VIII. SYSTEM ARCHITECTURE</i>	5
<i>IX. FUTURE WORK</i>	6

Executive Summary—This report highlights one senior design team’s perseverance, dedication, and tenacity to overcome great odds and work through not one, not two, but 3 separate projects in the time allotted for one.

In this report is the thorough design and testing of several projects, the disillusionment when plans were smashed due to the ill-conceived notions of Amrit Adahal, and the resolution to pull out a simple circuit in the end. Throughout this report there was a distinct lack of involvement by Amrit, and it shows throughout. The design which our team was finally allowed to build worked well and we did an excellent job of not only accomplishing the things we set out to do, but doing it in the face of great difficulty.

I. BACKGROUND

Team Kill-A-Watt’s project was to be an integral part of the General Converter project for the United States Navy. This converter was to have an input range of 100V to 600V RMS AC or DC and an output range of the same 100V to 600V AC or DC with custom frequency selection for the AC frequency. The converter was to provide up to a quarter megawatt of power, be no more than a half meter cubed and have a 2 man carry weight, (approximately 300lbs). It was further desired that the converter be simple enough to have the capability of being set up in half a day, and have a 95% efficiency.

Team Kill-A-Watt’s job was to provide cold start capability for the converter over the entire range of voltages and frequencies. This entailed powering up a microcontroller which would then operate the power MOSFETs to provide for the output of the converter. Once powered on and into steady state the converter was to harvest it’s own waste heat through the use of thermos-electric generators (TEGs) and be self-sustaining.

In this project, which was overseen by Amrit Adahal, we would be working with another senior design team, team HEAT. As their name implies they were working with the TEGs to harvest the excess heat from the converter for its steady state, self-sustaining operation.

Team HEAT’s design hinged on the use of phase change cooling to provide the necessary temperature differential to get power out of the TEGs. Since that is how TEGs work, they use metals as a catalyst to convert a temperature differential into current flow. The most significant impact of their research though was that if they didn’t get their design to work, there was no future for ours. This is because without a steady state to turn our process over to start up would become sustained operation, (i.e. a wall wart style power supply). The reason for this approach was to attempt to make gains in the efficiency of the machine. As we were start up and there would be no output at the time of our operation we were exempt from energy efficiency concerns.

II. PROBLEM DEFINITION

As discussed in minor detail previously, our problem was to cold start a general converter on a wide range of possible

voltages and frequencies. More specifically however our design needed to:

- Start the converter
- Power the switching gate drivers and MCU during startup
- Use the TEGs from previous design project to achieve startup power
 - Heating them up without steady state operation
- Specifications
 - Work with 100-V to 600-V, 0-Hz to 60-Hz
 - Provide power for mcu: 5V @ 1W
 - Provide power for mosfet switches
 - -5 to 20V x 2
 - -5 to 6V x 2
 - Heat TEG which then produces the power
 - Team HEAT design converts to usable format
- Constraints
 - Reasonable startup time
 - Works simply on converter startup, no operator intervention
 - Detachable from system at steady state
 - Reasonably small
 - No batteries

III. PROJECT PLAN

Our timeline to accomplish these tasks is outlined below:

FALL 2016 TIMELINE

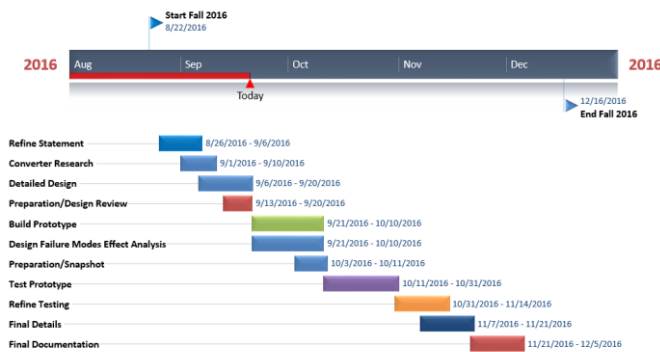

Figure 1: Fall 2016 Project Timeline

To help us in accomplishing things more efficiently and reliably we split up the responsibilities. This was a simple task for our group because the tasks fit our own unique abilities quite well.

- team responsibilities
 - recorder: rotating
 - treasurer: Nathan Gaul
 - speaker: shared
 - moderator: Mathew Klein
 - agenda writer: rotating
 - portfolio: Jake Querubin, Matthew Klein, Abdencio Sanchez
 - wiki page: Abdencio Sanchez, Jake Querubin
 - poster board: Mathew Klein

IV. CONCEPTS CONSIDERED

As is common with most projects, we began our answer search with brainstorming and we came up with a list of possibilities which fit our constraints.

- Brainstorming Results: power sources/storage
 - wireless energy harvesting
 - large capacitors
 - piezoelectric harvester
 - wall outlet
 - Use available power, (i.e. cellphone USB etc.)
 - Hand crank power generation
 - Piggyback by preheating TEGs

Of these results, we pared down our prospects to a couple of designs. We discussed the designs with Dr. Hess and he insisted that we split our small group in two and pursue both designs. This seemed like double the work, but as Dr. Hess said once we finished the project we were done. Whether we did it in 32 weeks or 8. Bearing this in mind we decided that trying both approaches would be to our benefit as we had twice the chance for success.

The two designs we pursued were resistive heating to pre-heat the TEGs, and a half-wave rectifying voltage-clamping power converter.

Jake and Abdencio's idea was to simply take the initial AC voltage source and rectify using a Full-Wave Rectifier to get a DC voltage. The idea behind the first circuit shown below was to step down the large range of voltage using power resistors. Since efficiency is not a concern, the amount of power losses in resistors was neglected. This preliminary design can be seen in the Figure 4.

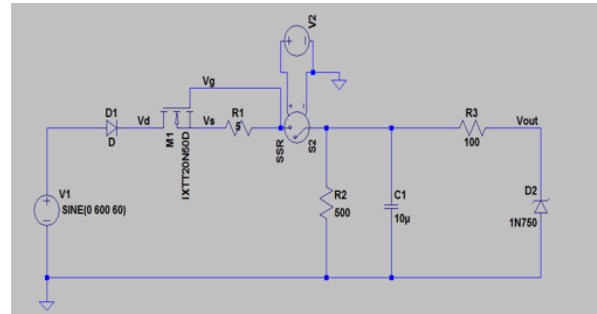

Figure 4: Self Regulating AC-DC Converter

This was achieved by setting up the circuit as a voltage divider where majority of the voltage got dropped. It took us a long time to realize that this approach was not feasible, due to the fact that some resistors don't have a power rating as to what we want it to do. The capacitor was put in place for filtering, smoothing voltage or frequency. The Zener diode was placed to regulate the voltage and force the 5V out as to what were expecting. Another disadvantage to this was that the circuit relied too much on the Zener diode, if it failed then there would be high voltage on the micro controller and potentially damage the system. Starting with this linear system we learned that we could not deal with the variance in input with such a simple system.

From the design above, we had to make some modifications to fulfill our requirement. Since the resistors developed too much heat and the current was not sufficient enough to provide power to the controller, we had to improvise. An advice was taken into consideration when Matthew suggested us to use a depletion mode MOSFET (normally on) that could be used to act as a variable resistor. The depletion mode MOSFET was capable of handling the voltage input range we were working with and using a current limiting resistor in series it produced a constant current value regardless of the input voltage range. With enough current we then used a Zener (voltage clamping) diode to get 5V and be able to power on the microcontroller until the TEGs through normal operation would take over as main power production. As the TEG took over, the TEG gave enough voltage to the relay to cut our system off continue the self sustaining process and for efficiency purposes.

V. CONCEPT SELECTION

Both designs had their advantages and disadvantages. The idea of pre-heating the TEGs was appealing because it was simple, cheap, self-isolating thanks to a feedback mechanism for switching a relay when voltage on the TEGs reached a threshold, and had very little impact on the overall design. The only disadvantage to pre-heating the TEGs were the thermal considerations. These concerns had been discussed with Rachel who was assisting with the thermal and mechanical side of the project. She told us in no uncertain terms that this project was not feasible due to the “un-sound” assumptions made by Amrit Adahal. When these concerns were brought to the attention of the group, it was decided that we should proceed with what we were doing, because it didn’t matter for our project because we could still produce a product which would work and fulfill the parameters of the assignment/project.

Using the half-wave converter circuit to directly power the MCU had the benefits that it was also simple and inexpensive with few parts. It’s disadvantages included having little in the way of protection, and a potential for failure considering how much it was relying on the Zener diode to get the voltage to the right value.

VI. PROJECT RE-SCOPE 1

When we returned this semester only needing to order parts and build our thoroughly researched designs we were told that the team HEAT project failed. It sounded like the thermal considerations Rachelle had spoken of were finally realized in the failure of their design.

Our new objective then was to design, build, and test a power supply. One very much like the \$5 ones which are purchased in any store, or used every day to charge laptops. To help get this stage of the project started quickly Matthew ordered some parts for us to use so that we could experiment with creating a switch mode power supply. It was good brainstorming material to get us thinking about what we wanted to do, and how we wanted to approach the problem at hand.

VII. PROJECT RE-SCOPE 2

Due to time constraints and semester coming to an end there was not enough time to fulfill the new needs of Amrit’s design. For this reason, we were given the option to create two circuits using KiCad. This was done for the purpose of having the experience of being able to design, build, and test a prototype as to what course entails.

VIII. SYSTEM ARCHITECTURE

The design of a push-pull MOSFET configuration was justified by Amrit because Abdencio was having a hard time programming the TI hardware. It was asked of Abdencio if he would be okay with designing the PCB instead and it was decided that we would go that route. As if we had a choice! Asking Abdencio to learn to program the TI in that short period of time was unreasonable and Amrit probably knew better.

That is, if his past performance was any indication, (see denial of thermal problems toward the beginning of this report).

Figure 5 is the schematic of a DC-DC converter created using KiCad. The design consists of an Isolated DC-DC converter chip (R1S-1224/HP) to isolate the input and output side. The chip has a 2:1 ratio meaning it will convert the lower input voltage to a higher output voltage. In this design 10 Volts will go through pins 1 and 2 of the chip and output 20 Volts through pins 4 and 5 of the chip. On the left side of this design the capacitors are used as decouplers to filter out the high frequency noise to prevent damage to the chip. The inductor is used to tune the DC-DC converter chip to get the desired output voltage. On the right side of design, the capacitors are used as decouplers to filter out high frequencies. The resistor is used to limit the amount of current and the Zener diode is used for voltage protection/regulation on the output side. The output voltage will be used by the driver side of the Gate Driver design shown in Figure 6.

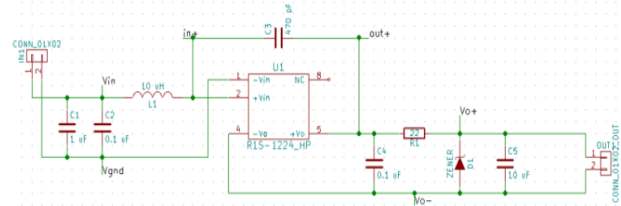

Figure 5: 10V-20V DC-DC Converter

Figure 6 is one of four of a half bridge quad inverter. The goal of this design is to simply have the power MOSFET switch on or off. The gate driver consist an IC chip (Si8271) that has an isolated input and ground on both sides. In the driver side of the chip an input voltage is attached from the output of the DC-DC converter. Another source is applied to the input side of the chip to turn the chip on. All PWM drivers include programmable dead time, which adds a user-programmable delay between transition of Vo+ and Vo-. The amount of dead time delay (DT) is programmed by a single resistor connected to the input. Vo+ and Vo- are the pathways for the current to flow and act as a sink or source depending on if the transistor is on or off. Lastly the parallel connected capacitors are used as decouplers to filter out higher frequencies.

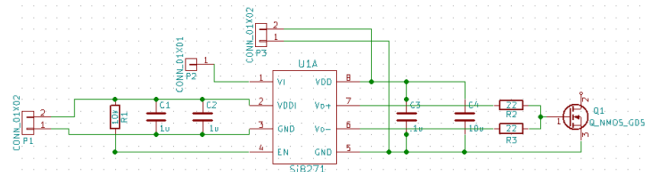

Figure 6: Gate Driver Circuit

In the process of designing and building this circuit in the few weeks between snapshot and Expo we learned.

- Circuit Board CAD
- Board Spacing
- Trace Size and Power Capability
- Signal Isolation
- High Frequency PCB Design Considerations
- PCB Board Milling Process

If all these criteria are met and Kicad presents no errors during the design rule check the boards are ready to be etched and assembled. The board layouts and their respective assembly can be seen below in Figures 7, 8, 9 and 10.



Figure 7: DC-DC Converter Layout

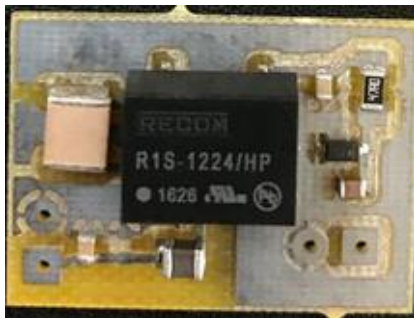

Figure 8: DC-DC Converter Assembly

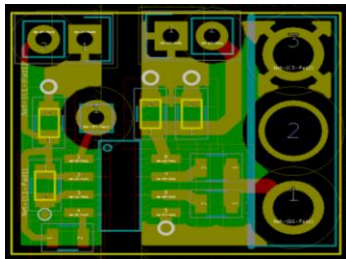

Figure 9: Gate Driver Layout

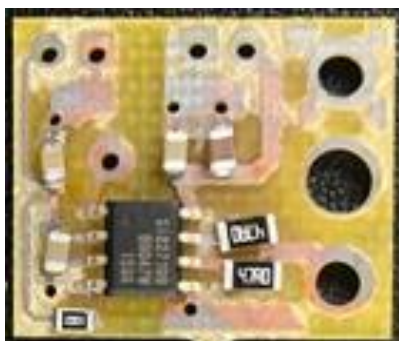

Figure 10: Gate Driver Assembly

IX. FUTURE WORK

Some suggested future work for this design and other projects like it would be to take the individual boards and assemble them into a single board. This would reduce signal noise between connected systems, allow for greater flexibility in board layout, and greatly improve the cleanliness of the final product. Along with this, a high quality board manufacturer is suggested for long lasting board construction.

To increase the power capacity of the system multiple switching devices could be placed in parallel for a 'larger' current path. Design and testing would be needed as it takes a longer period of time to switch multiple devices in parallel.