

# Transactive Energy

## Prosumers are the Way

By: Matthew Springer, Joshua Ropp, Zhiyu Chen, Liwei Liu, Fan Meng



# PROBLEM STATEMENT

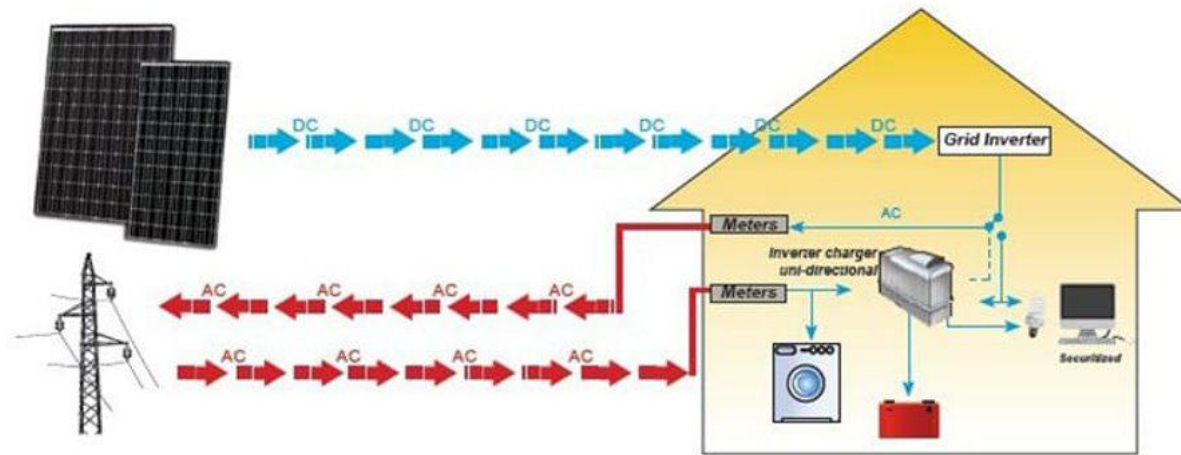

With the addition of reverse power due to Solar (Photovoltaic or PV) panels, we want to analyze how this reverse power flow would impact a small distribution system.

# PROJECT GOALS

1

Implement PV into the IEEE 13-bus distribution system

2

Run a power flow analysis on the system

3

Test whether the PV will bring the bus voltages within 5% of the optimal operating point

# PV (Photovoltaic) Panels

Data from the National Solar Radiation Data Base

Our PV Profile:

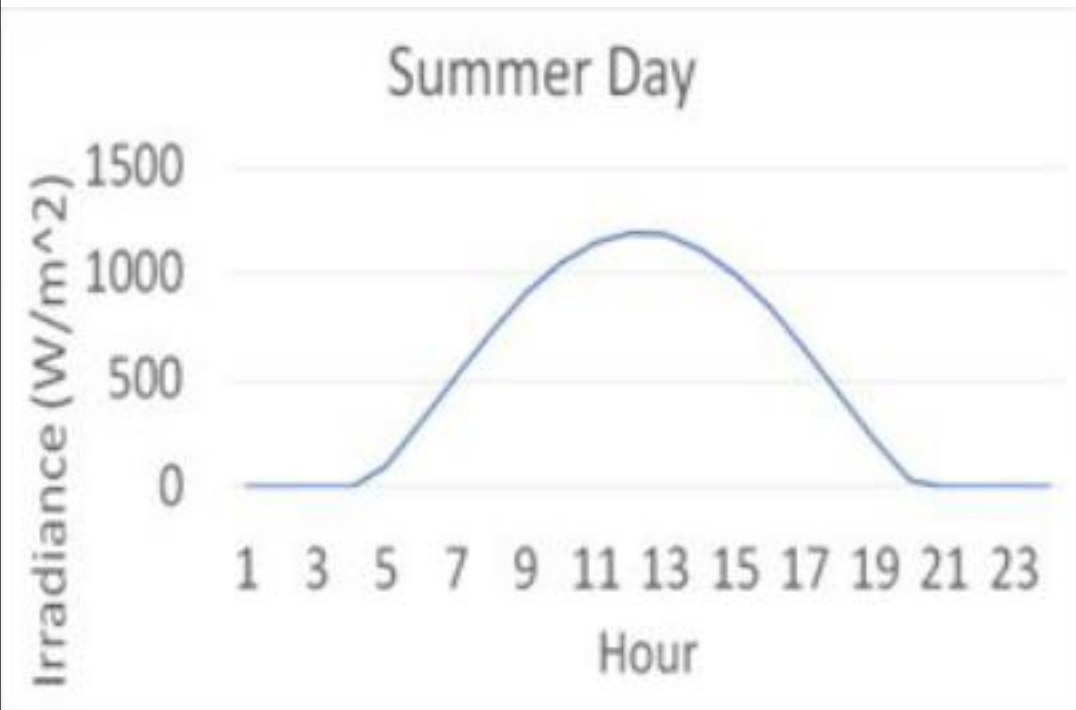

Transformed to per unit



# OpenDSS Implementation

# Reasons for using OpenDSS

- Needed a program that could be changed dynamically
- Open source so we didn't run into licensing issues
- Ease of communication with other software such as Python

# OpenDSS Objectives

- Implement PV profile into the system to see how the distribution system reacts.
- Create Plots of the Power, Voltage, and Current of a specified node over a specified time interval.
- Export all Data to a CSV file to later be analyzed.

# IEEE 13 Bus

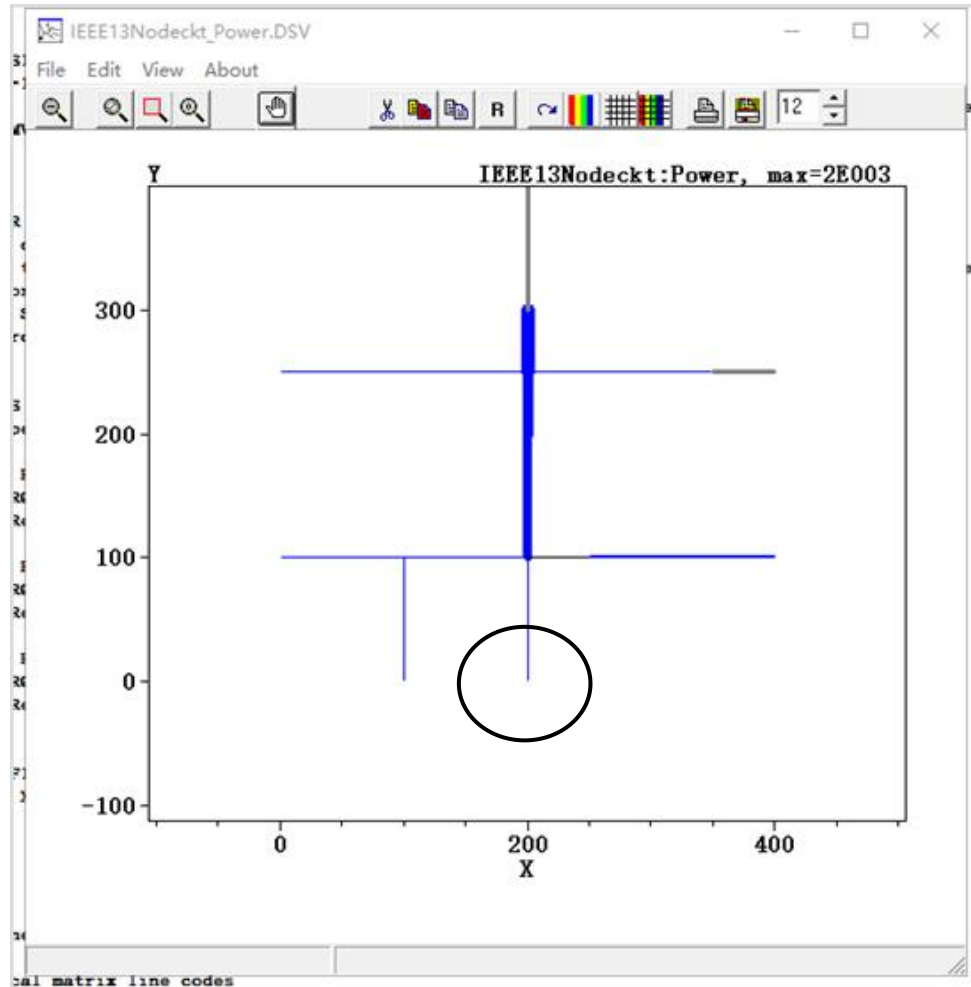

We added solar power to Bus 680 and then analysed its response to the power.

We also added monitors to the system so that we can monitor to get all the data as shown.



# OpenDSS Script

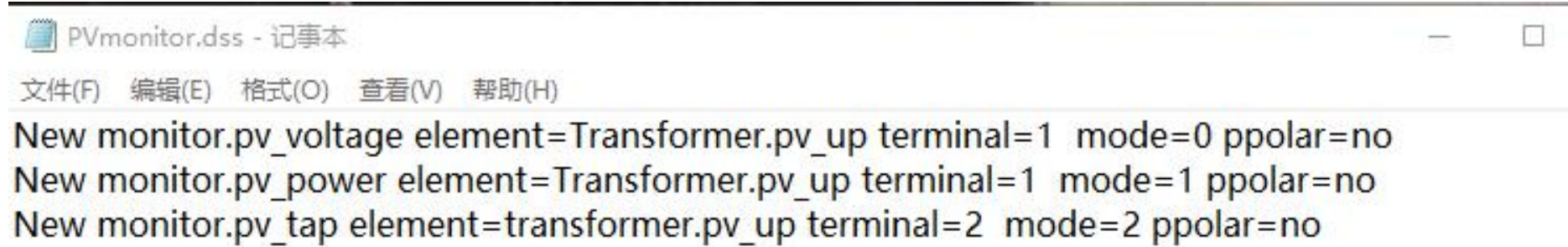

```
PVmonitor.dss - 记事本  
文件(F) 编辑(E) 格式(O) 查看(V) 帮助(H)  
New monitor.pv_voltage element=Transformer.pv_up terminal=1 mode=0 ppolar=no  
New monitor.pv_power element=Transformer.pv_up terminal=1 mode=1 ppolar=no  
New monitor.pv_tap element=transformer.pv_up terminal=2 mode=2 ppolar=no
```

We added monitors to the system so that we can monitor to get all the data as shown.

# PV in OpenDSS

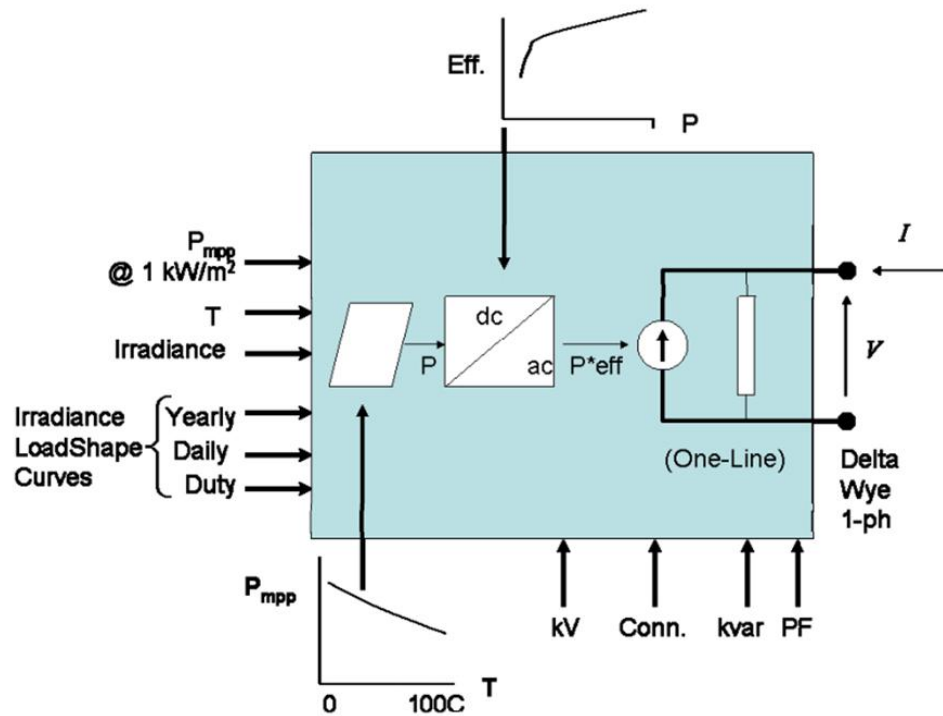

Figure 1. Block Diagram of the PVSystem Element Model

```
// PV define
New XYCurve.MyPvsT npts=4 xarray=[0 25 75 100] yarray=[1.2 1.0 0.8 0.6]

New XYCurve.MyEff npts=4 xarray=[.1 .2 .4 1.0] yarray=[.86 .9 .93 .97]

New Loadshape.MyIrrad npts=24 interval=1 mult=[file=data.txt]

New Tshape.MyTemp npts=24 interval=1 temp=[25, 25, 25, 25, 25, 25, 25, 25, 35, 40, 45, 50 60 60 55

New PVSystem.PV phases=3 bus1=trafo_pv kV=0.4 kVA=500 irrads=1 Pmpp=1000 temperature=25

New Transformer.pv_up phases=3 xhl=5.750000
~ wdg=1 bus=trafo_pv kV=0.4 kVA=750.000000 conn=wye
~ wdg=2 bus=680 kV=4.16 kVA=750.000000 conn=wye
```

Figure 1 shows a schematic diagram of the PVSystem device model recently implemented into OpenDSS version 7.4.1 at Build 28.



# Summer Day

## Power

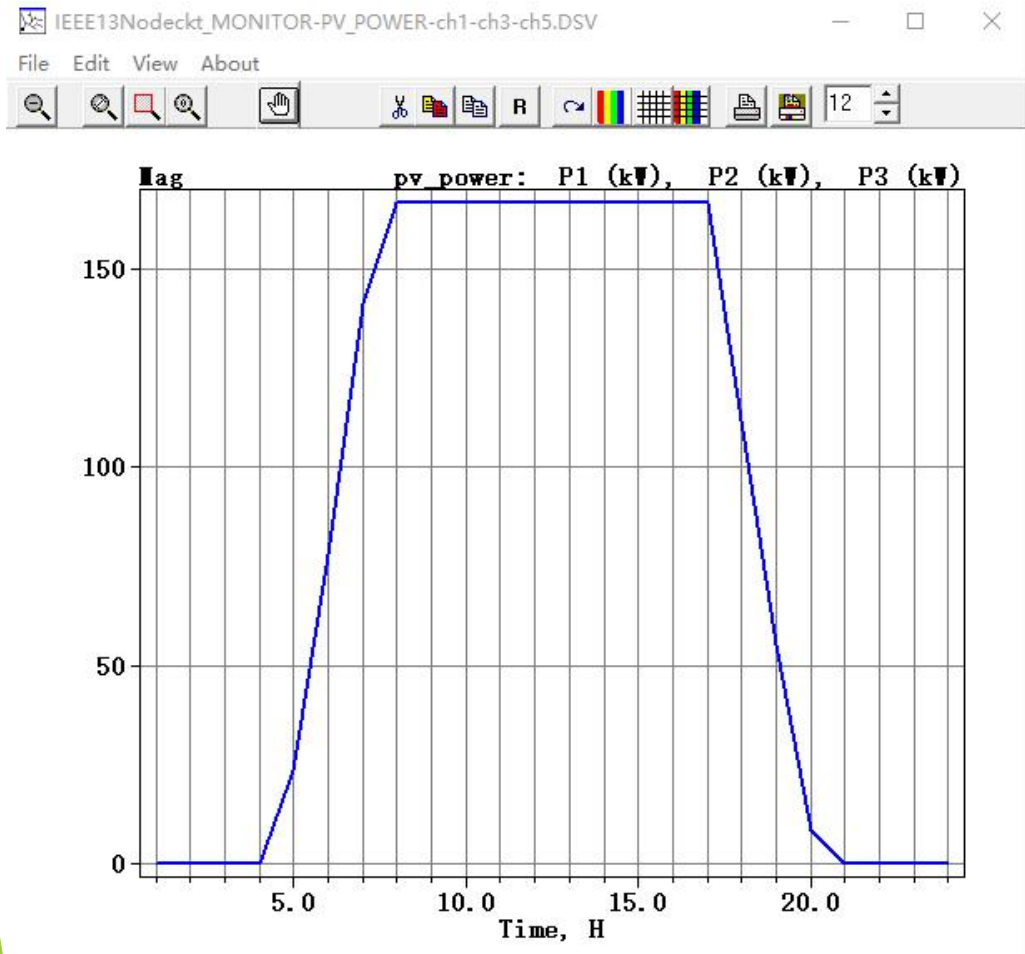

## Voltage

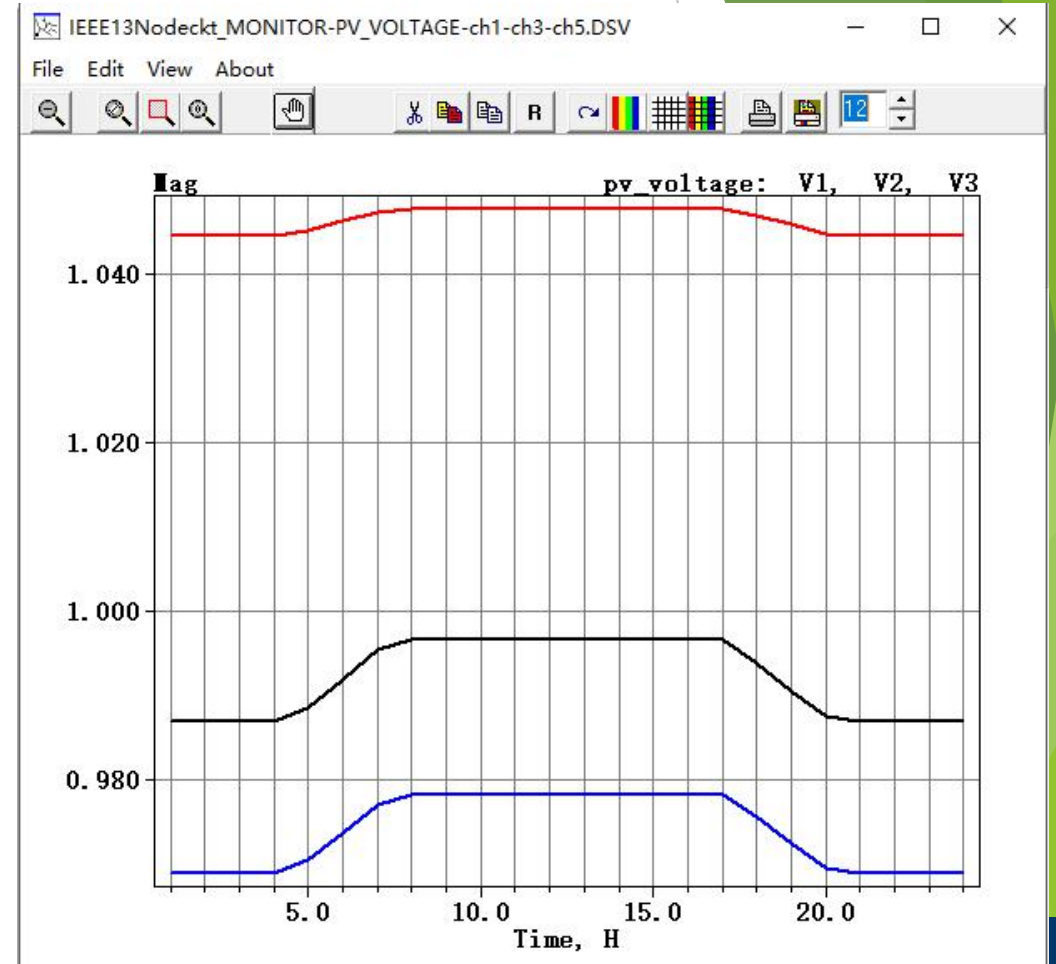

# Summer Week

## Power

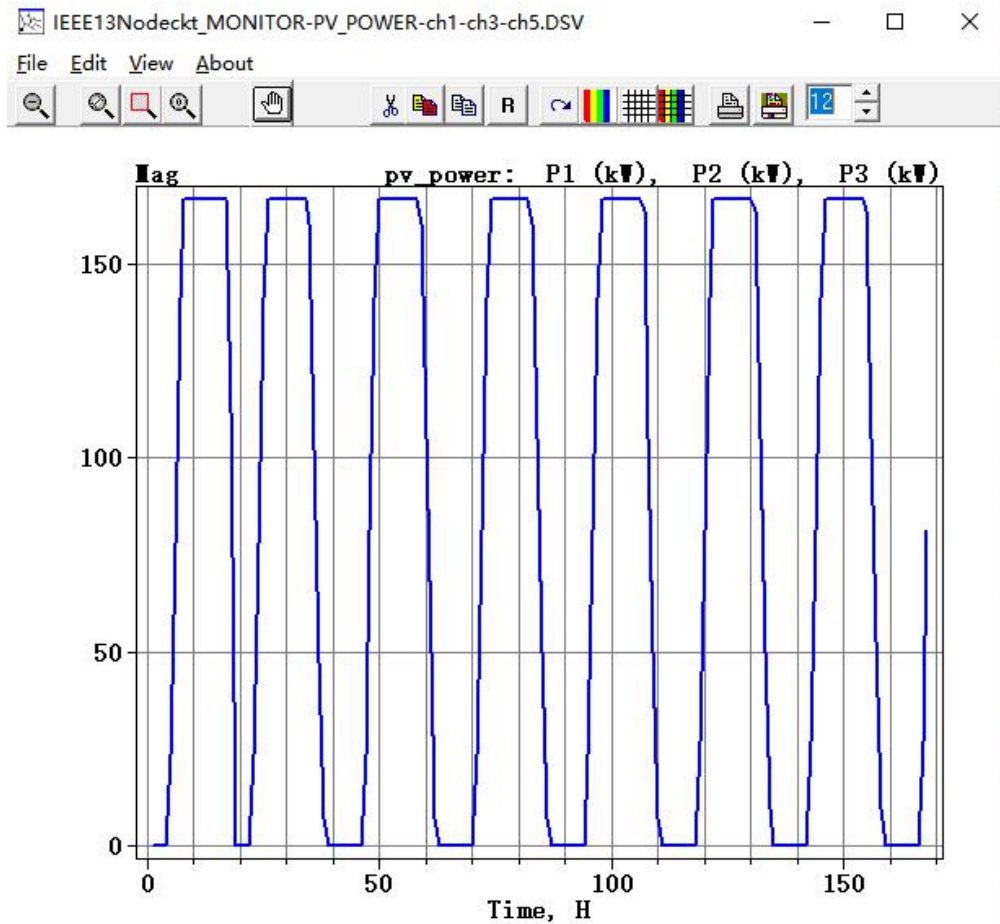

## Voltage

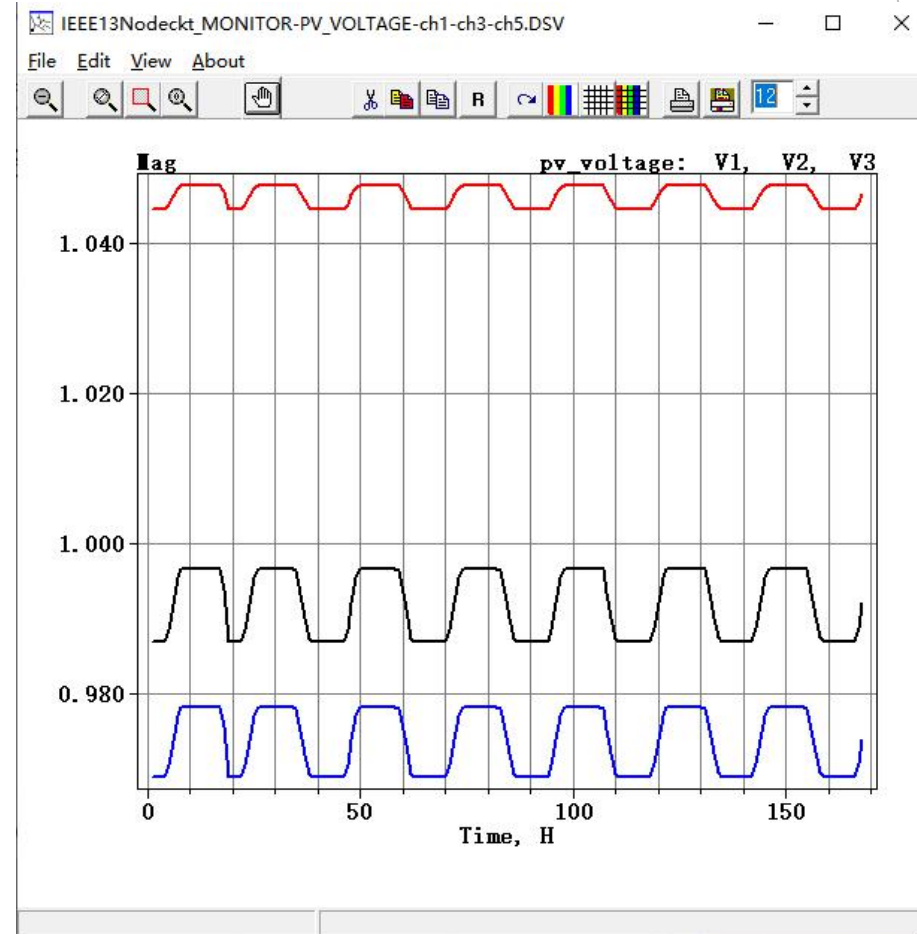



# Summer Month

## Power

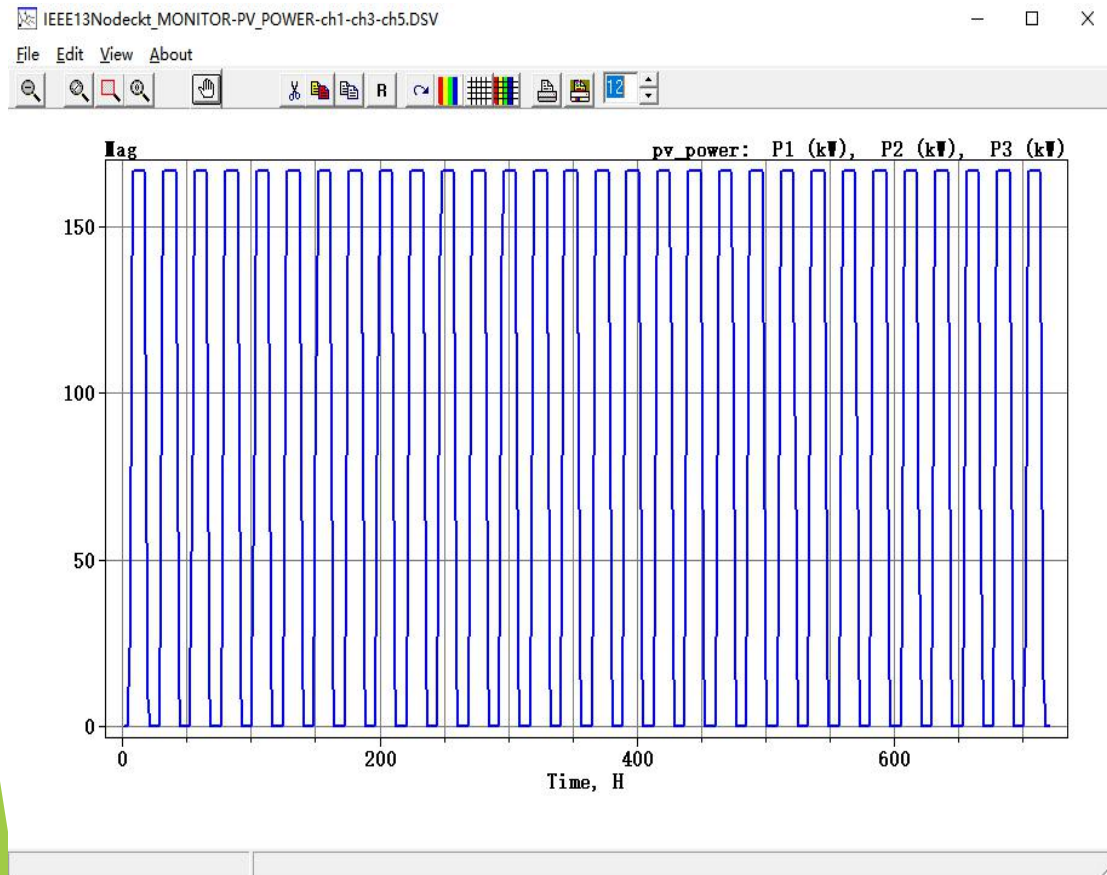

## Voltage

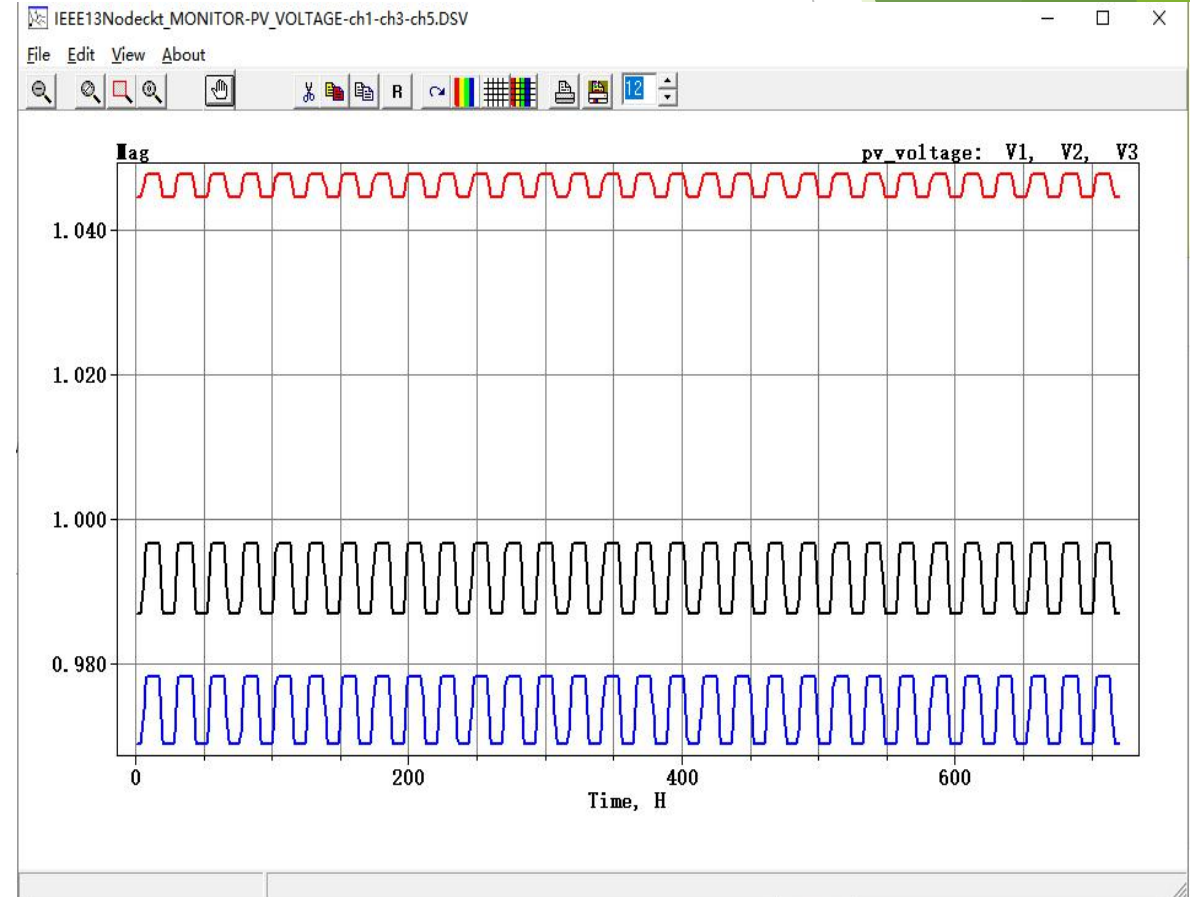

# Simulink Implementation

The model does not include the regulating transformer between nodes 650 and 632

$P = [17 \ 66 \ 117] * 1e3 / 2 \text{ W}$   
 $Ql = [10 \ 38 \ 68] * 1e3 / 2 \text{ var}$   
 $Qc = [0 \ 0 \ 0] \text{ var}$

632 Yg PQ

632 Swing bus  
 1.0210 pu -2.49  
 1.0420 pu -121.72  
 1.0174 pu 117.83

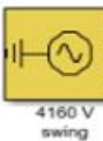

632

632



646\_Z  
 $P = 230e3 \text{ W}$   
 $Ql = 132e3 \text{ var}$   
 $Qc = 0 \text{ var}$

646

645-646

645

632-645

632-633

633

633

XFM-1  
 4.16 kV / 480 V

634



634 Yg PQ  
 $P = [160 \ 120 \ 120] * 1e3 \text{ W}$   
 $Ql = [110 \ 90 \ 90] * 1e3 \text{ var}$   
 $Qc = [0 \ 0 \ 0] \text{ var}$

PQ  
 $P = 170e3 \text{ W}$   
 $Ql = 125e3 \text{ var}$   
 $Qc = 0 \text{ var}$

632-671

$P = [17 \ 66 \ 117] * 1e3 / 2 \text{ W}$   
 $Ql = [10 \ 38 \ 68] * 1e3 / 2 \text{ var}$   
 $Qc = [0 \ 0 \ 0] \text{ var}$

671 Yg PQ

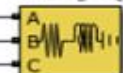

Power-Flow Results

Phasor 60 Hz

powergui

671



$P = [385 \ 385 \ 385] * 1e3 \text{ W}$   
 $Ql = [220 \ 220 \ 220] * 1e3 \text{ var}$   
 $Qc = [0 \ 0 \ 0] \text{ var}$

671 D PQ

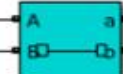

Breaker

692

692

692-675

675

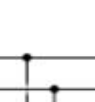

675 Yg PQ  
 $P = [485 \ 68 \ 290] * 1e3 \text{ W}$   
 $Ql = [190 \ 60 \ 212] * 1e3 \text{ var}$   
 $Qc = [0 \ 0 \ 0] \text{ var}$

611 Z

$P = 0 \text{ W}$   
 $Ql = 0 \text{ var}$   
 $Qc = 100e3 \text{ var}$

611 I

$P = 170e3 \text{ W}$   
 $Ql = 80e3 \text{ var}$   
 $Qc = 0 \text{ var}$

611

684-611

684

671-684

671-680

684-652

652

652 Z  
 $P = 128e3 \text{ W}$   
 $Ql = 86e3 \text{ var}$   
 $Qc = 0 \text{ var}$

680

692 D I  
 $P = [1e-6 \ 1e-6 \ 170] * 1e3 \text{ W}$   
 $Ql = [0 \ 0 \ 151] * 1e3 \text{ var}$   
 $Qc = [0 \ 0 \ 0] \text{ var}$

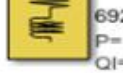

675 Yg PQ  
 $P = [485 \ 68 \ 290] * 1e3 \text{ W}$   
 $Ql = [190 \ 60 \ 212] * 1e3 \text{ var}$   
 $Qc = [0 \ 0 \ 0] \text{ var}$



675 Yg Z  
 $P = [0 \ 0 \ 0] \text{ W}$   
 $Ql = [0 \ 0 \ 0] \text{ var}$   
 $Qc = [200 \ 200 \ 200] * 1e3 \text{ var}$



IEEE 13 Node Test Feeder

?

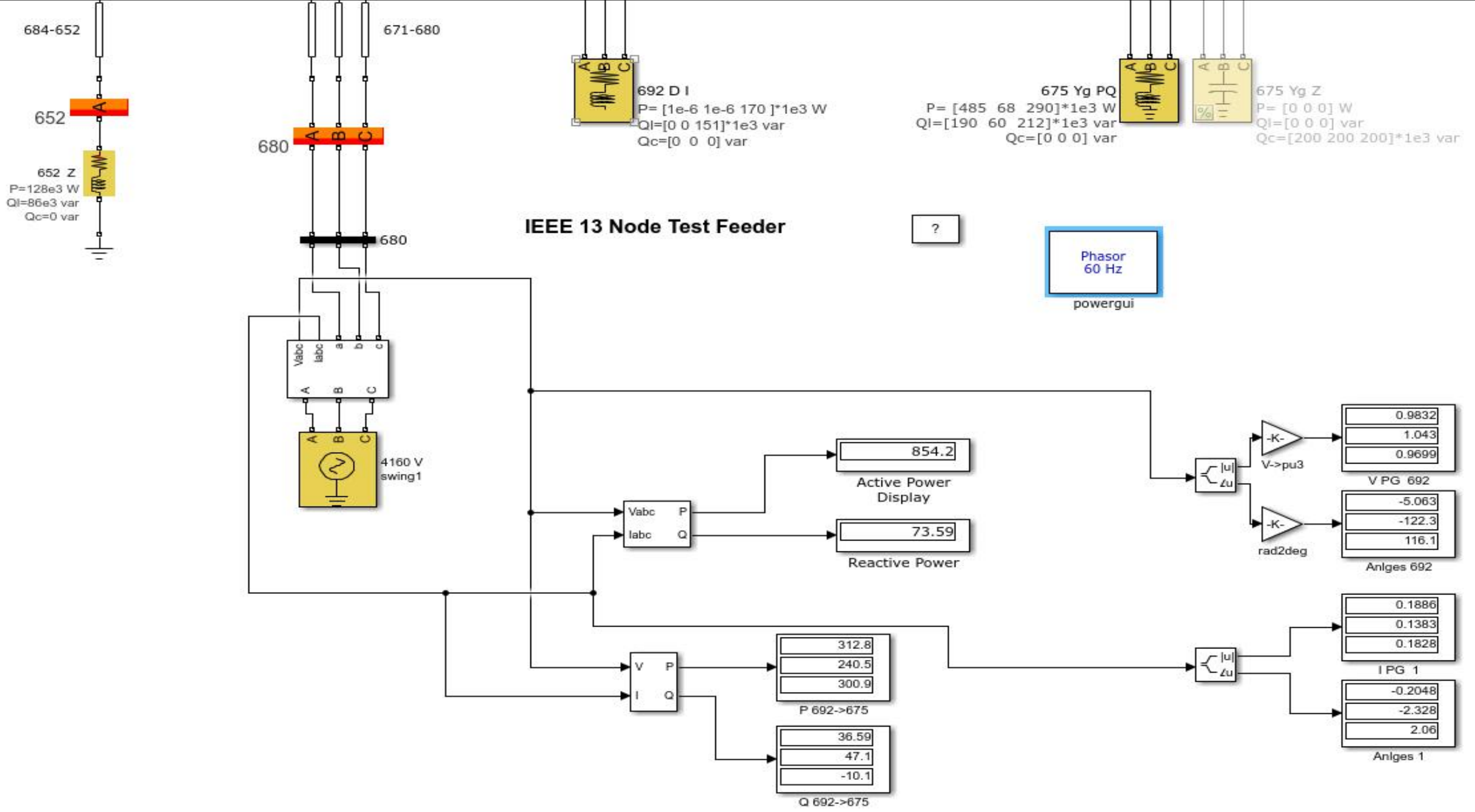



# At Bus 680

## Input Power

Input Power (3 Phase)

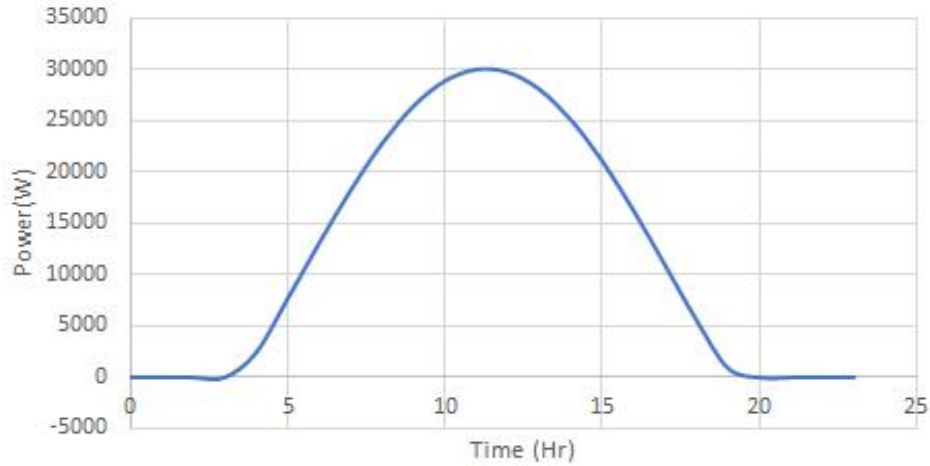

Input Power(1 Phase)

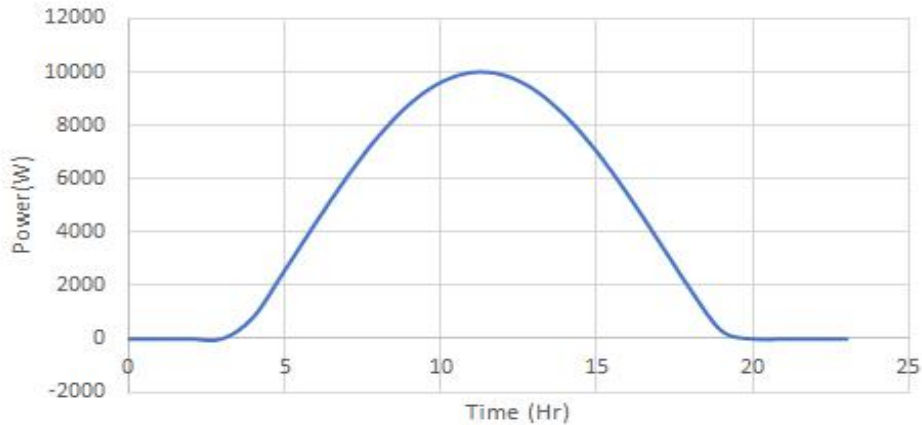

## Output Power

Output Power(3 Phase)

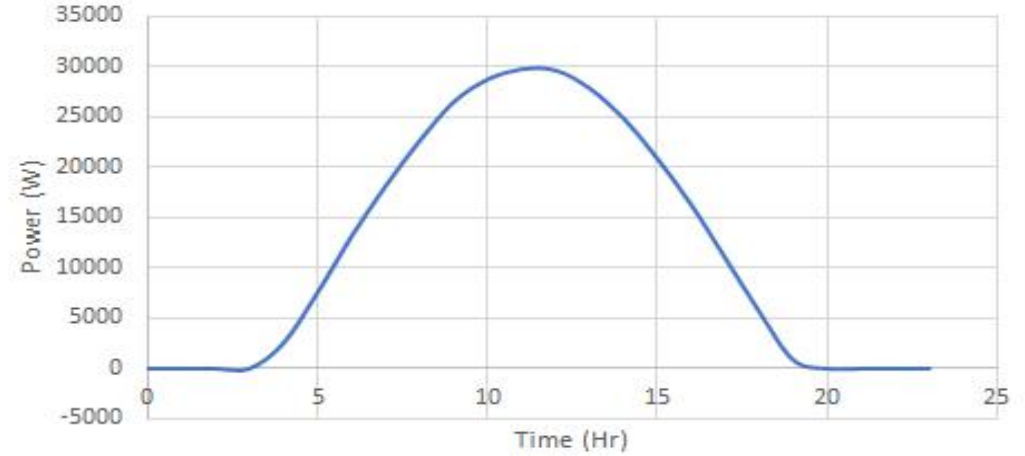

Per Phase Power Output

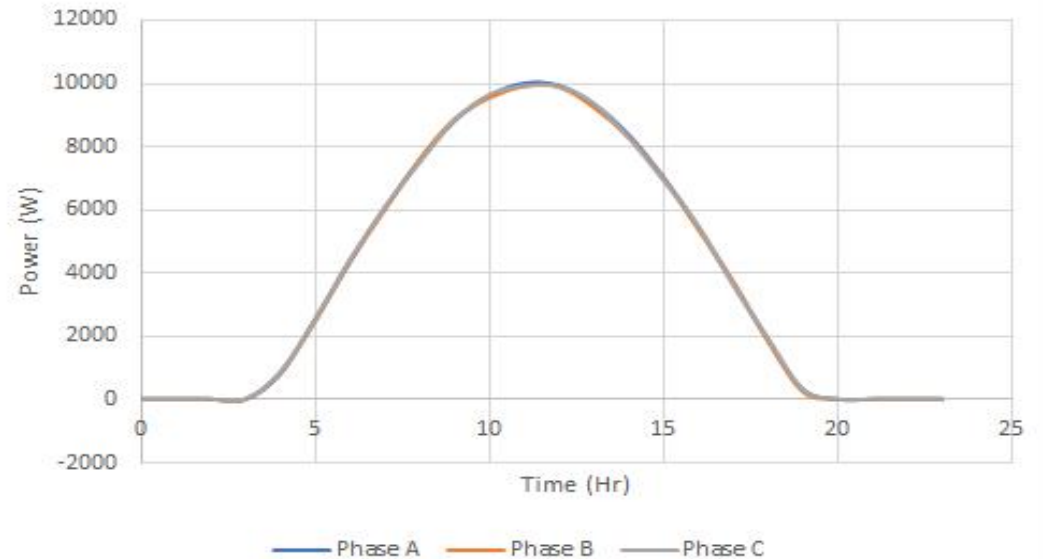

At a power factor of 1 so there will be no reactive power

# At Bus 680

## 3-Phase Voltage

Per Phase Voltage Magnitude Output

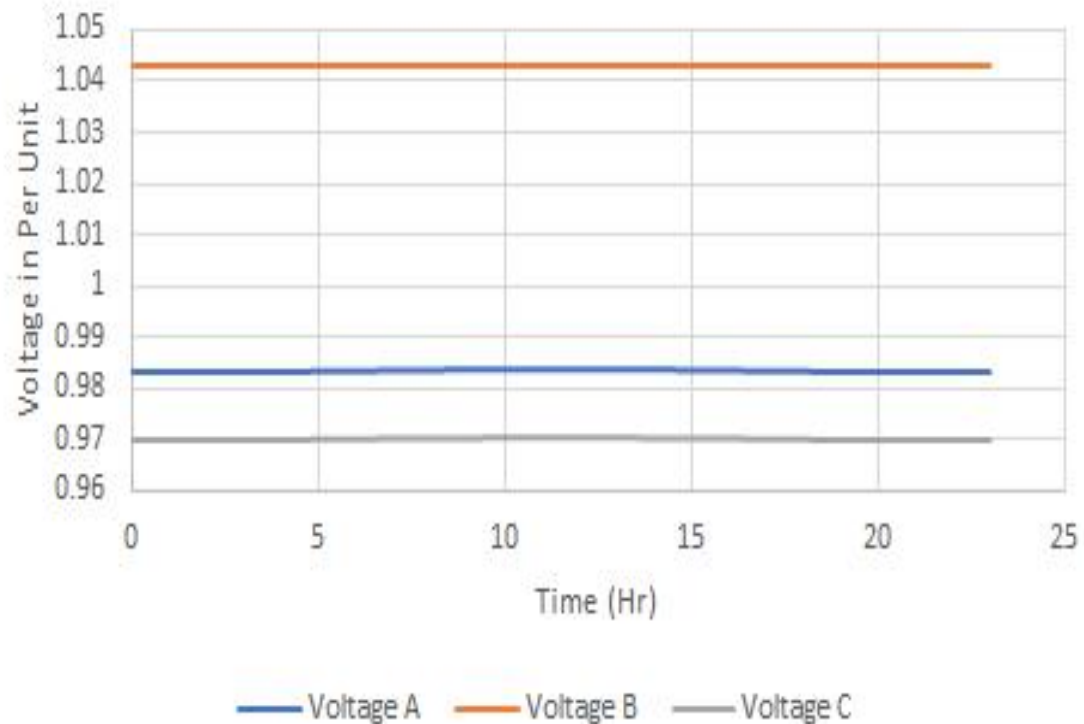

## 3-Phase Current

Per Phase Current Output

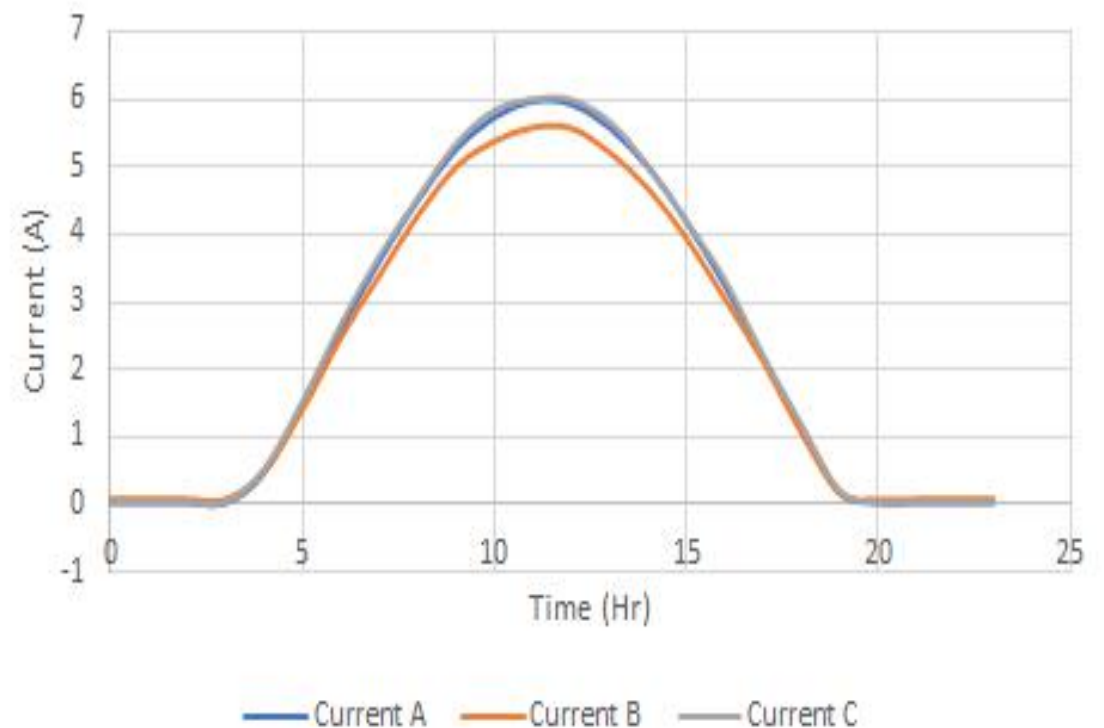

# Conclusio

n

- After analysis, the residential PV will not overload bus 680
- Phase B voltage on the bus is about 1% away from overloading the bus.
- This is a concern and will need to be watched when adding more PV panels to the system.

# Questions?

