



University of Idaho
College of Engineering



DISCOVERY
Center of Idaho

GESTURE CONTROL ROBOT ARM EXHIBIT

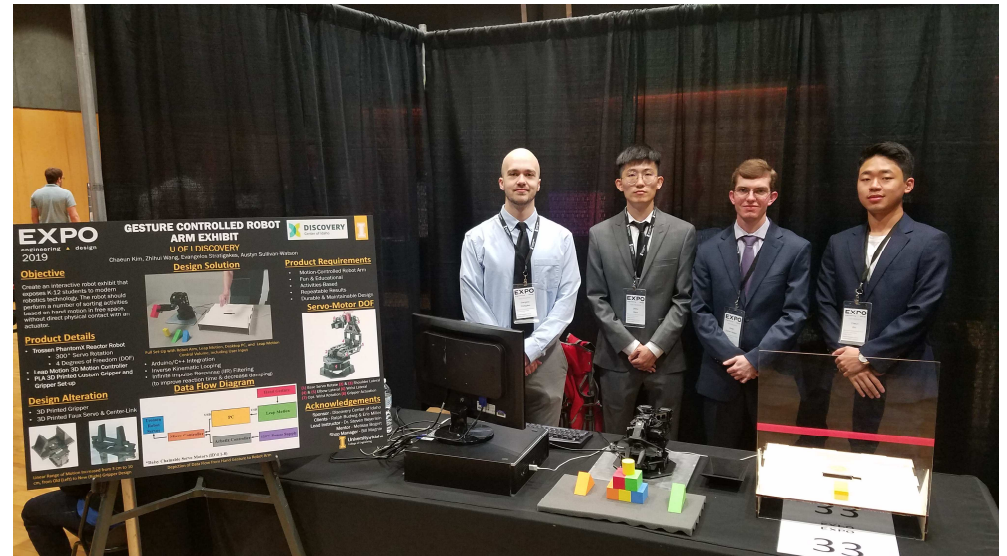

CHAEUN KIM, ZHIHUI WANG, EVANGELOS STRATIGAKES, AUSTYN SULLIVAN-WATSON

PROJECT OBJECTIVES

- Equip the Discovery Center of Idaho with their first fully functioning, motion actuated robotics exhibit.
- Incorporate interactive exhibits that expose K-12 students to modern robotics technology.



PRODUCT REQUIREMENTS

- Fun and Educational for Children
- Activities Based (Completing Task)
 - Block Sorting
 - Interactive Mode
- Repeatable Experience
 - Consistent User Experience
 - Short User Learning Curve
- Durable Design
 - Replacement Parts
 - Custom Parts



SYSTEM & COMPONENTS

● Equipment and Devices

- Trossen PhantomX Robot Arm
- ArbotiX Micro-Controller
- Leap Motion 3D Motion-Controller
- Desktop Computer

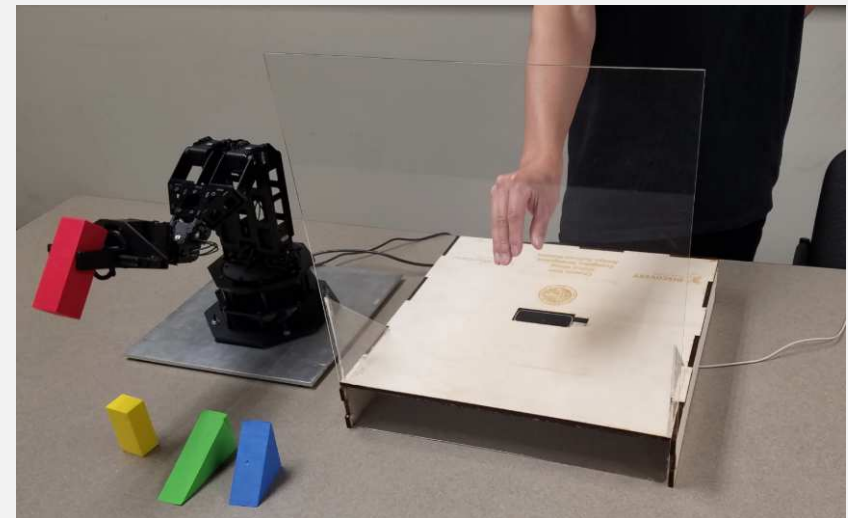
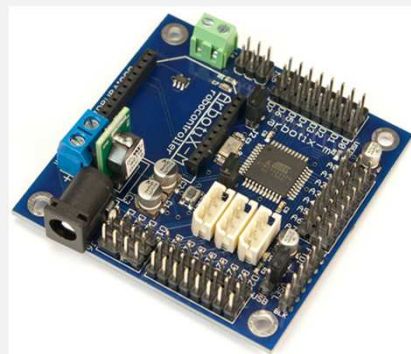

GRIPPER MODIFICATION



Old Gripper could only open 3 cm wide.

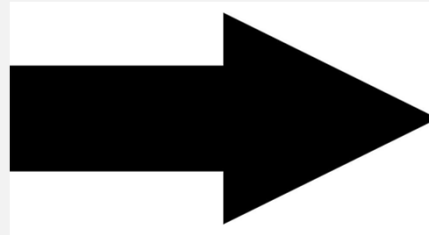

Manufacturing by 3D printer.



New Gripper can open up to 10 cm wide.

SYSTEM DIAGRAM

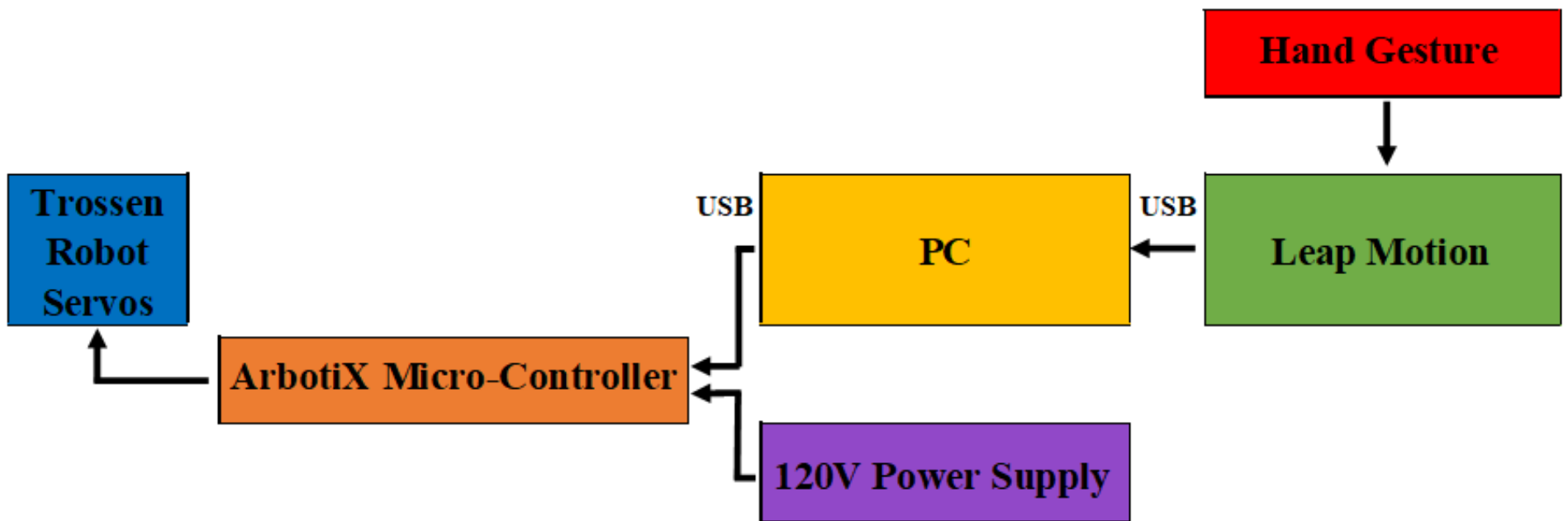

*Daisy Chainable Servo Motors (ID'd 1-8)



CODE DATA FLOW

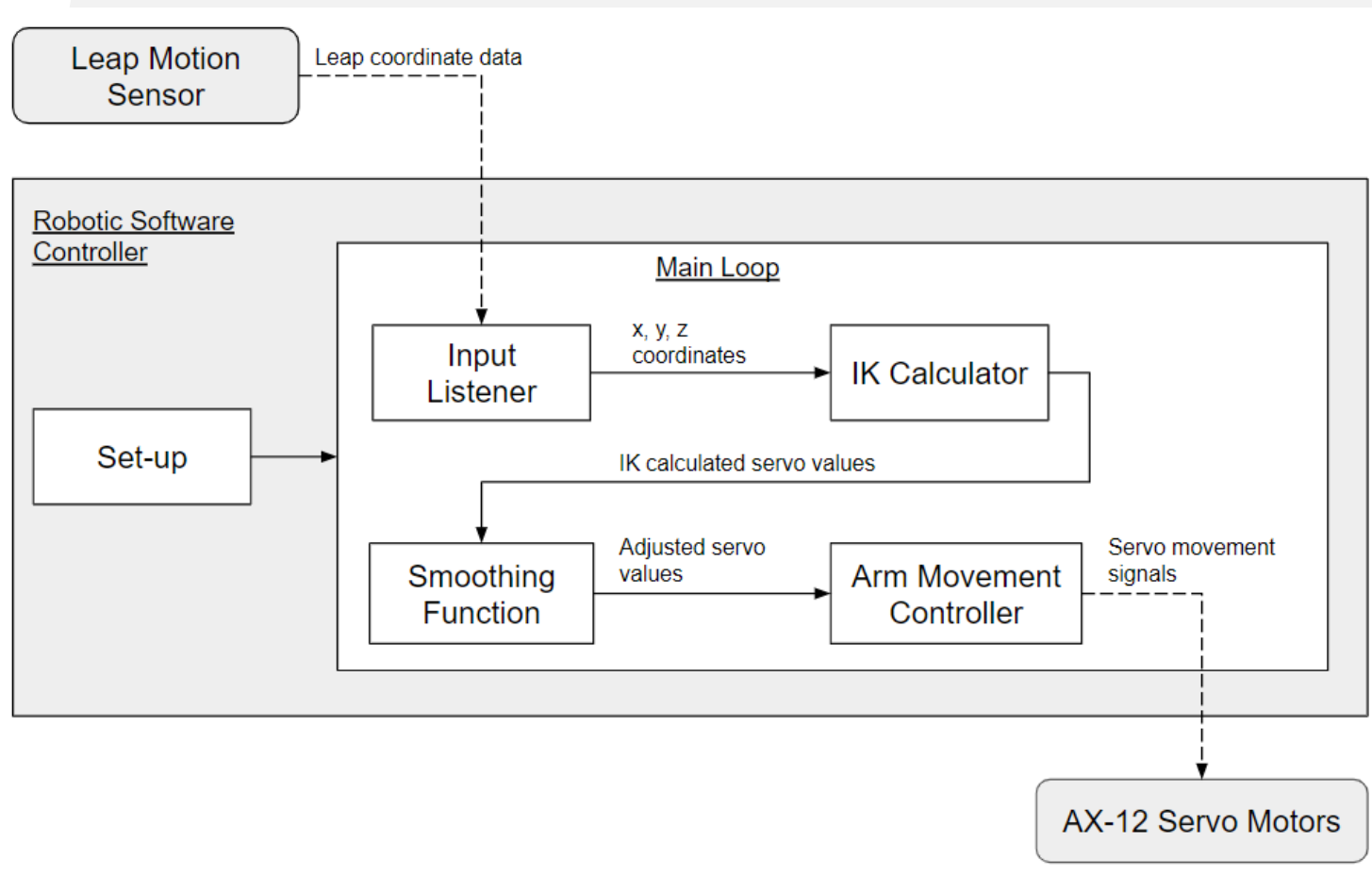



FUNCTIONING PROTOTYPE

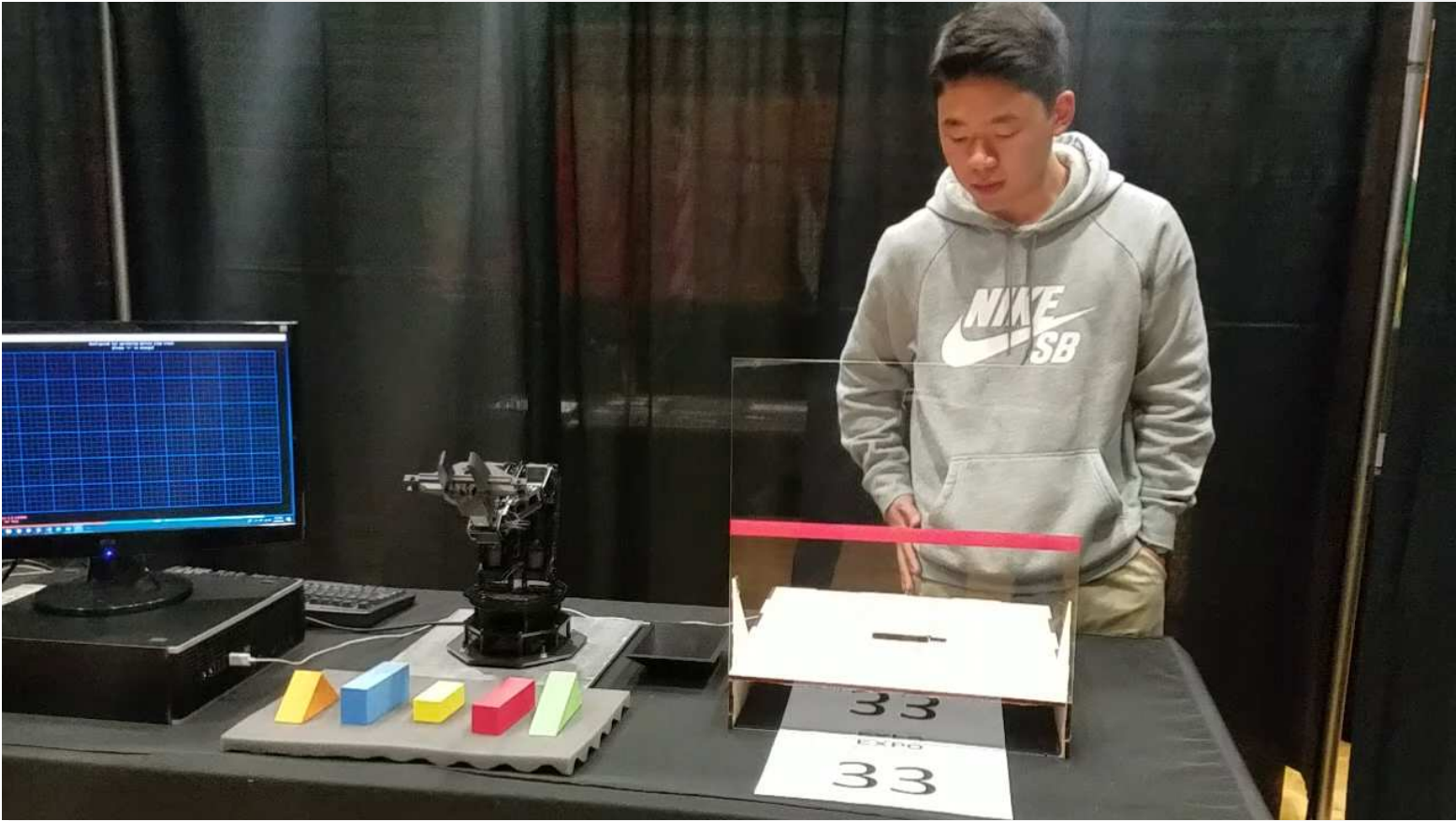

DESIGN VALIDATION

● Validation Tests

- Code to Servo Verification
- Hand Tracking Accuracy
- Hand Tracking Delay
- Smoothness of Actuation
- Range of Motion Studies
- Gripper Performance Studies



DESIGN VALIDATION



Senior Capstone Design

Project: [Discovery Center - Gesture Control Robotics Ex](#) Primary Author: [Austyn Sullivan-Watson](#)

Team: [U of I Discovery](#)

Date: **April 7th 2019**

Design Validation Plan & Results (DVP&R)

Call Out	Test	Target Date	Completed	Performance	Result	Actions
Leap Motion						
Base Servo-Motor Actuation (Servo-Motor ID #1)	Free Rotation, with the 300 Degrees of Motion, Using leap motion to rotate the arm 90 deg. w/ hand motion	11/1/2018	10/24/2018	Completed, with refinements on the way. Actuation occurs, though it could be improved.		Purchase the U2D2 Converter, in hopes of reducing the amount of conversions needed. Look into reducing latency.
	Rotation using Servo-Motor ID #1 on the base via Arduino Software.	11/1/2018	11/1/2018	Completed, with refinements on the way. The Arm actuates by itself to the upright position, through Arduino Coding		Continue progress, and look into actuating the arm through Inverse Kinematics through Leap Motion. Look into reducing latency.
	Rotation using Servo-Motor ID #1 on the base via Arduino/C++ Code Mod.	2/13/2019	1/30/2019	Completed, base servo actuates, and moves side-to-side, mirroring user input. Latency isn't detrimental		See if reaction speed can be improved, but more than anything, functionality is of highest priority



PROJECT TIMELINE

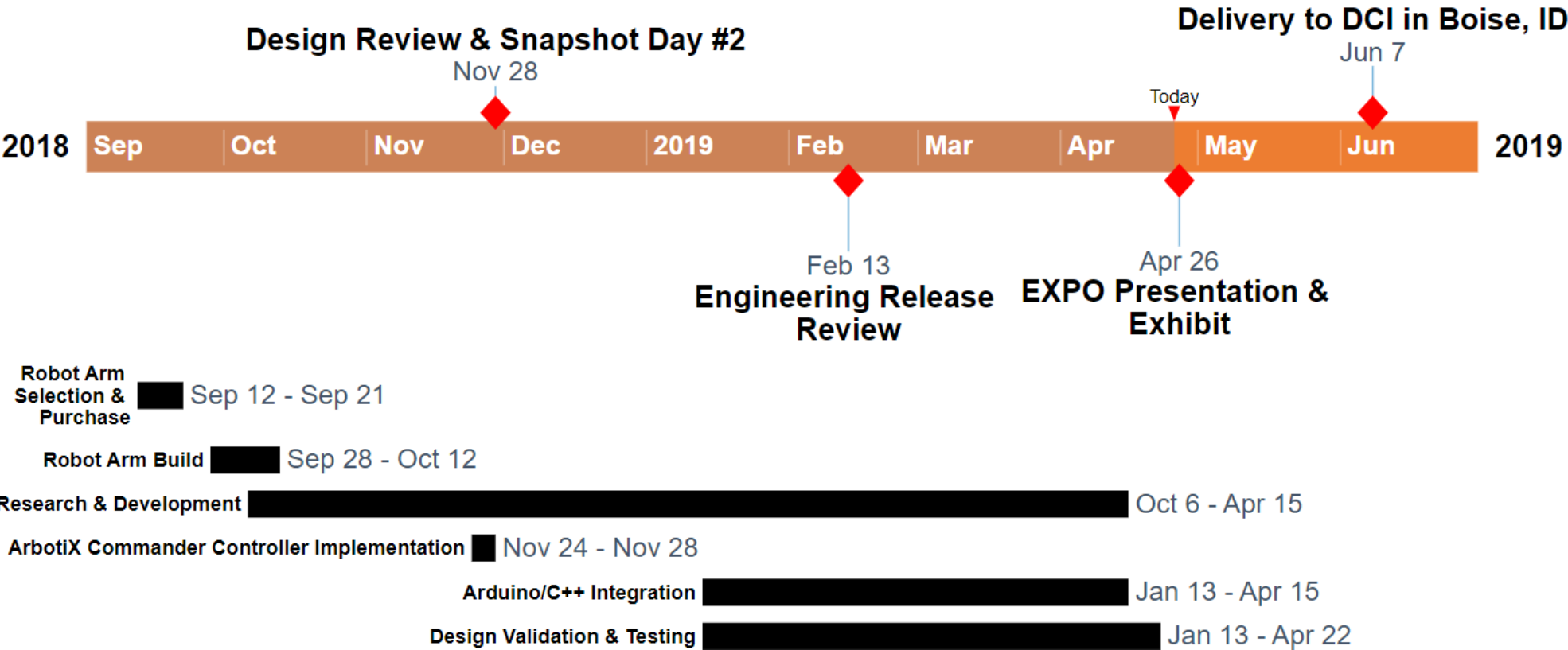

PROJECT FINAL DELIVERABLES

- Fully assembled robot arm, controllable via Leap Motion controller
- Software program/programming to control robot arm
- User Guide and Documentation
- Specific Replacement Parts and Part Files
- Deliver Final Product to DCI

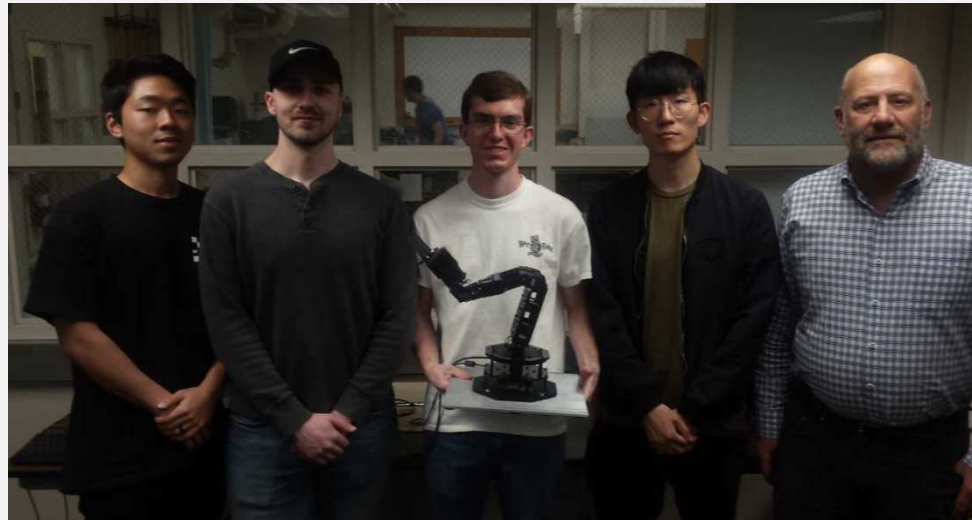

FUTURE DEVELOPMENT

- **Interactive Game Implementation**
 - Tangram Game
 - Connect Four Competition
 - Hasbro Operation Game

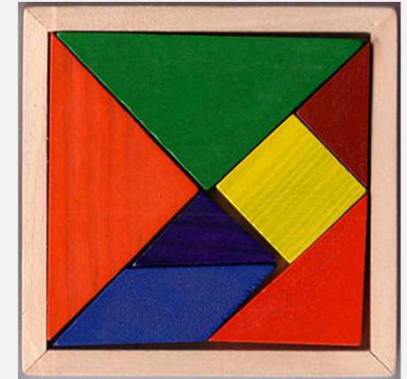

QUESTIONS?

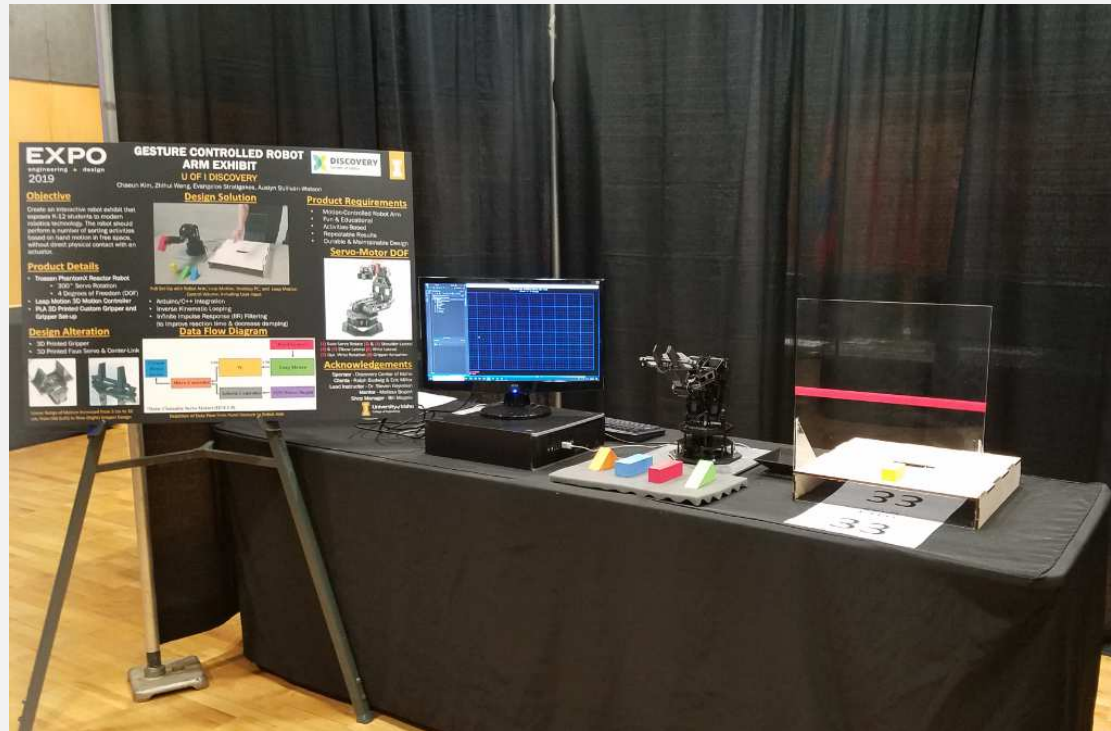

Make sure to stop by Booth 33 to try it out yourself!