

Carlos Santos, Cory Holt, Drew Malinowski,  
Meridian Haas

# FireWatch: Infrasonic Wildfire Detection Device

1

# Objective/Value proposition

# Wildfire Mitigation

3

- Current best means of detecting fire are seeing and smelling smoke
- It is known that wildfire gives off infrasound waves in range (0-20Hz)
- Our aim is to set up a mesh network of smart nodes and dumb nodes that can detect infrasound
- The ability to provide a signal to firefighting services when the fire is still small, could save countless homes and wilderness areas
- Will drastically improve our ability to mitigate wildfires

# Previous Project Work

# Team from 2018

5

- Main Focus: Wireless Communication
- We unfortunately don't have much documentation/results from them.
- They did not focus on the infrasound sensing aspect.
- They purchased 4 Yagi single dipole directional antennae for Xbee

# Project Requirements



# Project Requirements: Microcontroller

7

- Small form factor
- Lora Radio
- GPS
- Analogue to Digital Converters (ADC)
- Small but powerful processor (CPU)
- Low power modes

# Project Requirements: Mesh Network

8

- Send/Receive data over long distances
- Know which nodes are active and dead
- Send data quickly and reliably



# Project Requirements: Enclosure

9

- Fit within a 6in diameter cube
- Be able to withstand natural elements, drops from 100ft, and be shatter proof
- The total system shall weigh no more than 10 lbs
- The mechanical components shall be designed to operate indefinitely, including weather resistance except for fire damage
- Material must be able to resist sun and weather for extended time periods

# Project Requirements: Infrasonic Sensor

10

- Accurately detect infrasonic waves generated by wildfire
  - Will require adequate amplification
  - Vref output must be between 0 - 2 Volts
- -3 db cut-off frequency within 10 - 20 Hz
  - Cut out unwanted noise, such as wind
- As cheap as possible

# Risk Mitigation

# Risk Mitigation: Possible Risks

- Cyber Security
- Environmental Impacts
- Wildlife Impacts



**Danger**  
wild animals



# Current Design Work & Project Learning



# System Diagram

- Why TTGO T-Beam?

- Cheap
- Common components
- Well-documented
- Necessary peripherals on board

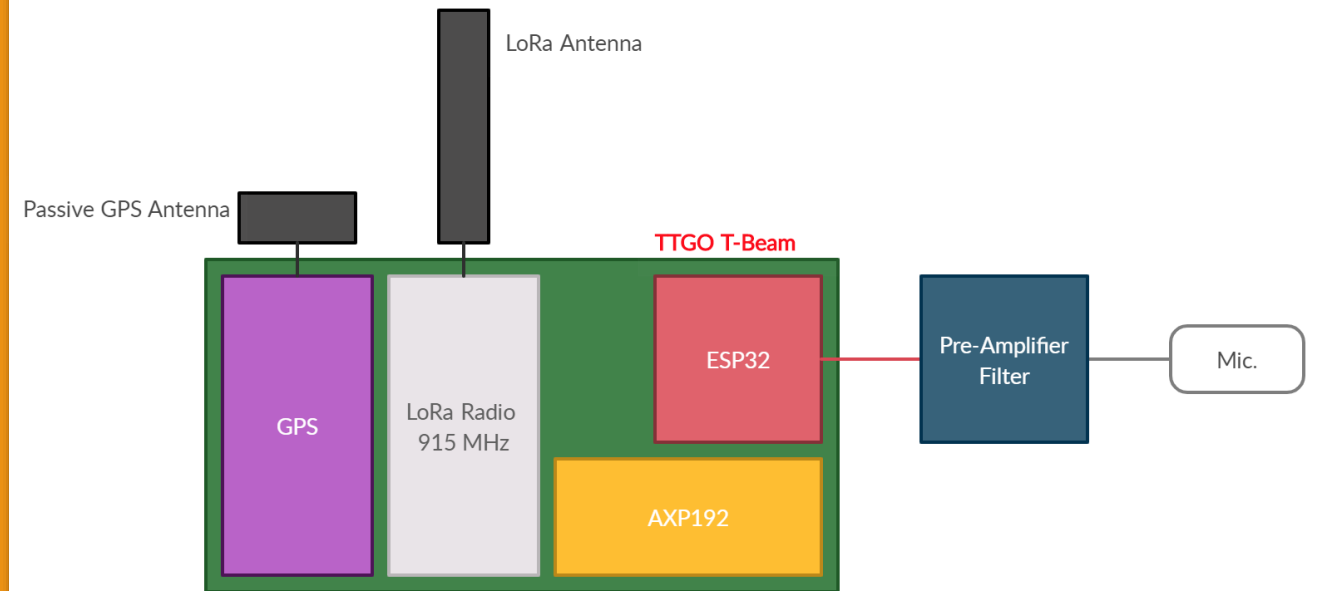

# MCU / Peripheral diagram

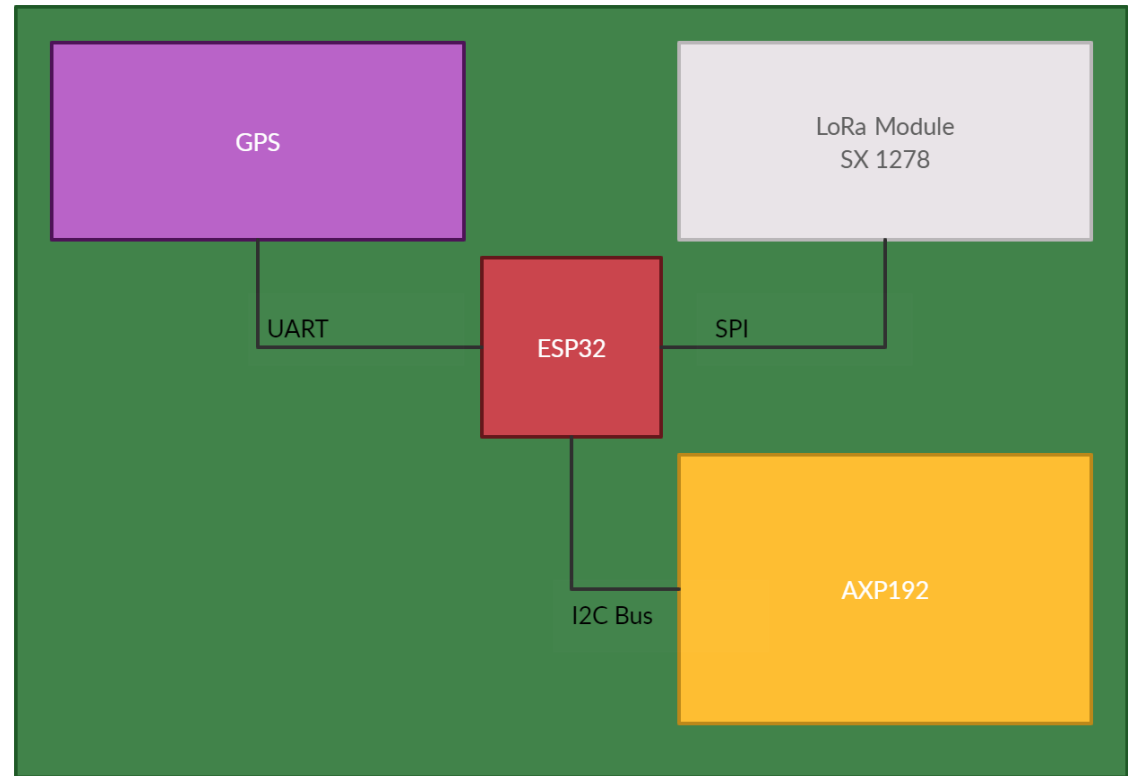

# GPS - uBlox NEO 6M

16

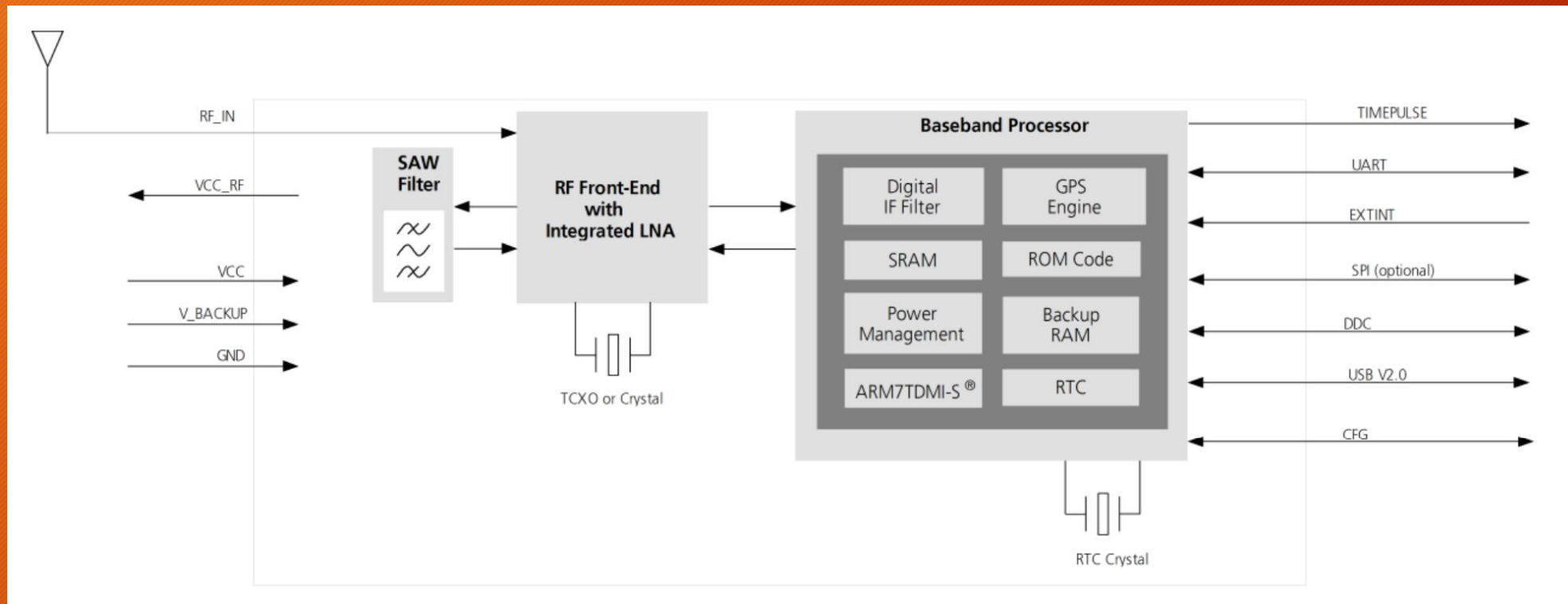

# GPS - Important features

- Real time clock
- 2.5 M location accuracy
- Power save mode - 75% lower power usage!

Parameter	Symbol	Module	Min	Typ	Max	Units	Condition
Max. supply current <sup>15</sup>	Iccp	All			67	mA	VCC = 3.6 V <sup>16</sup> / 1.95 V <sup>17</sup>
Average supply current <sup>18</sup>	Icc Acquisition	All		47 <sup>19</sup>		mA	VCC = 3.0 V <sup>16</sup> / 1.8 V <sup>17</sup>
	Icc Tracking (Max Performance mode)	NEO-6G/Q/T		40 <sup>20</sup>		mA	
		NEO-6M/P/V		39 <sup>20</sup>		mA	
	Icc Tracking (Eco mode)	NEO-6G/Q/T		38 <sup>20</sup>		mA	
		NEO-6M/P/V		37 <sup>20</sup>		mA	
Icc Tracking (Power Save mode / 1 Hz)	NEO-6G/Q		12 <sup>20</sup>		mA		
	NEO-6M		11 <sup>20</sup>		mA		

**Table 11: Indicative power requirements**

# LoRa Protocol

Why?

Low Bandwidth, Low power,  
long range

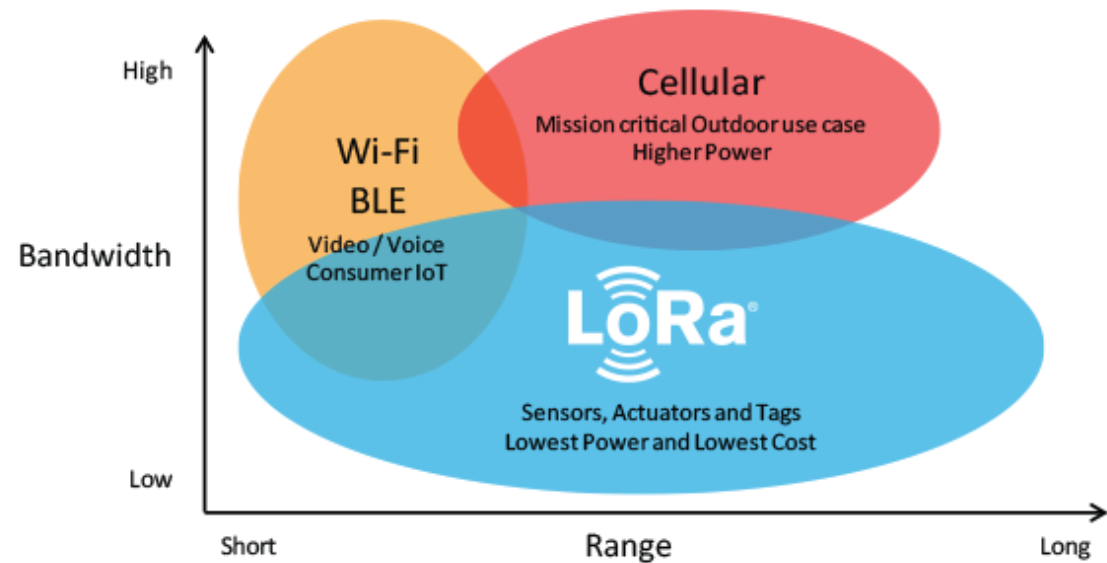



# LoRa packet structure

19

- Preamble - up to 65000 symbols to synchronize packet reading
- Optional header
  - Payload length
  - CRC
- Payload
  - Up to 255 bytes of data
- Optional CRC
  - Cyclic redundancy check
  - Detect transmission errors

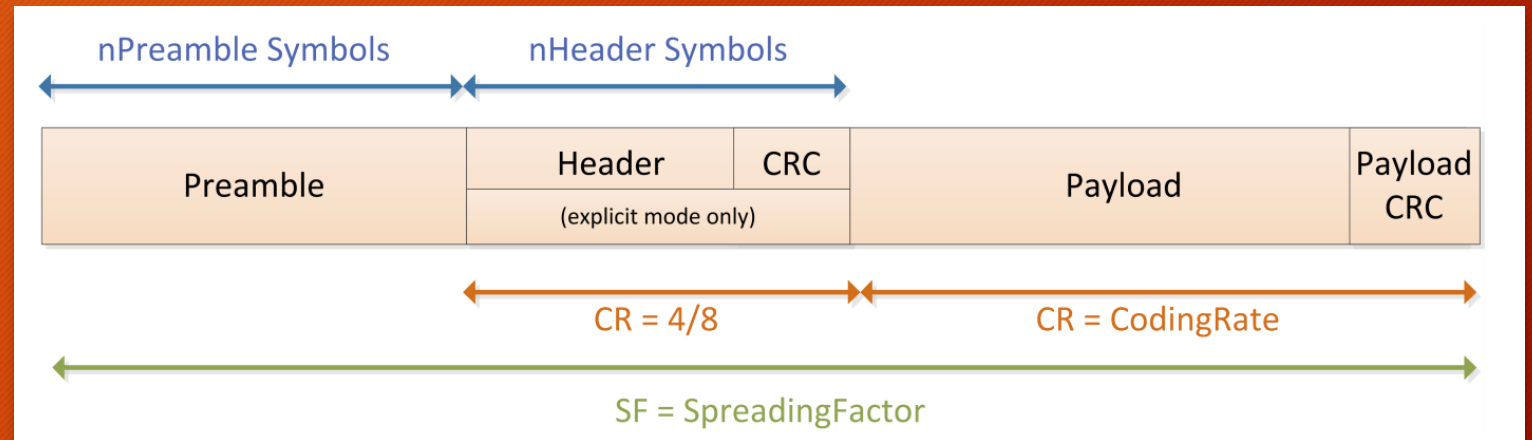

# Radio Module - SX1276

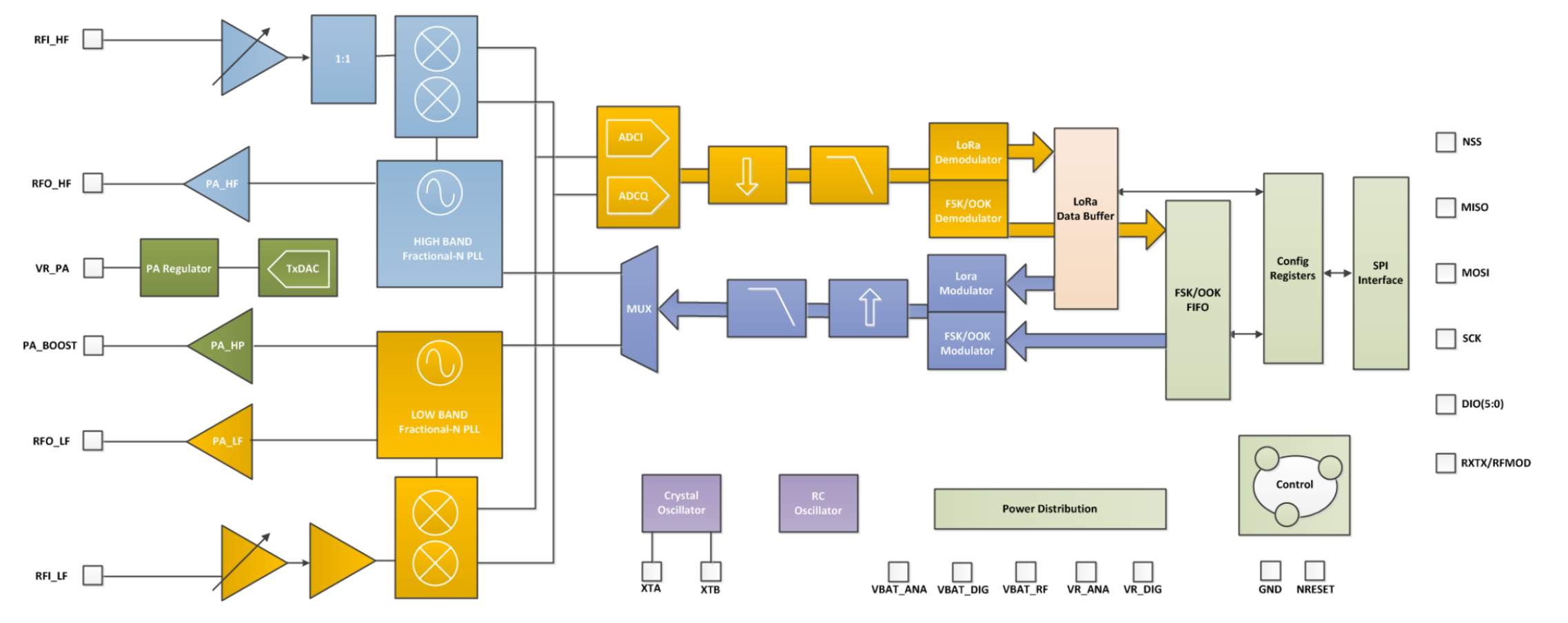

# Radio module configuration parameters

21

- Transmit power
  - 2 to 20 dB - default 17 dB
- Spreading Factor
  - High spreading factor increases range and power usage
- Preamble length
  - Up to 65000 bits
- Sync word
  - Kind of like a password for our network
- CRC on/off



# LoRa Demo

22

- Carlos has a simple demonstration of our Dev. Boards communicating

# Control Flow Diagrams

23

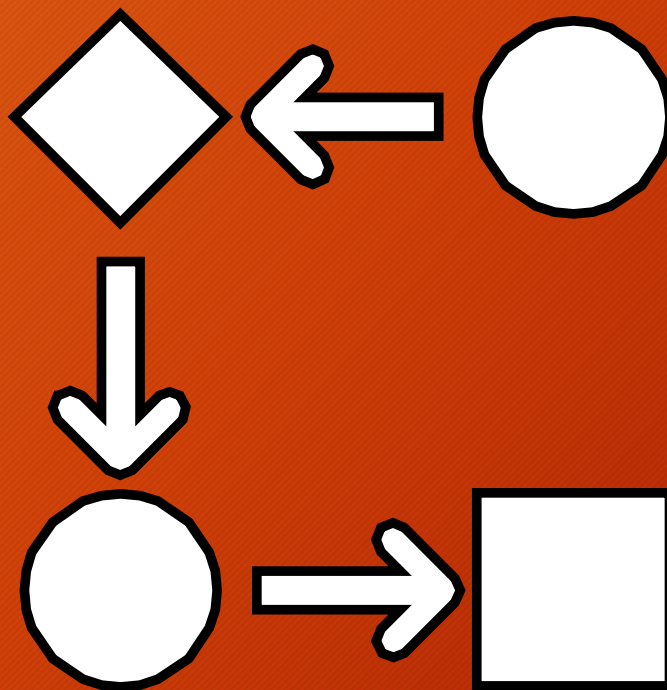



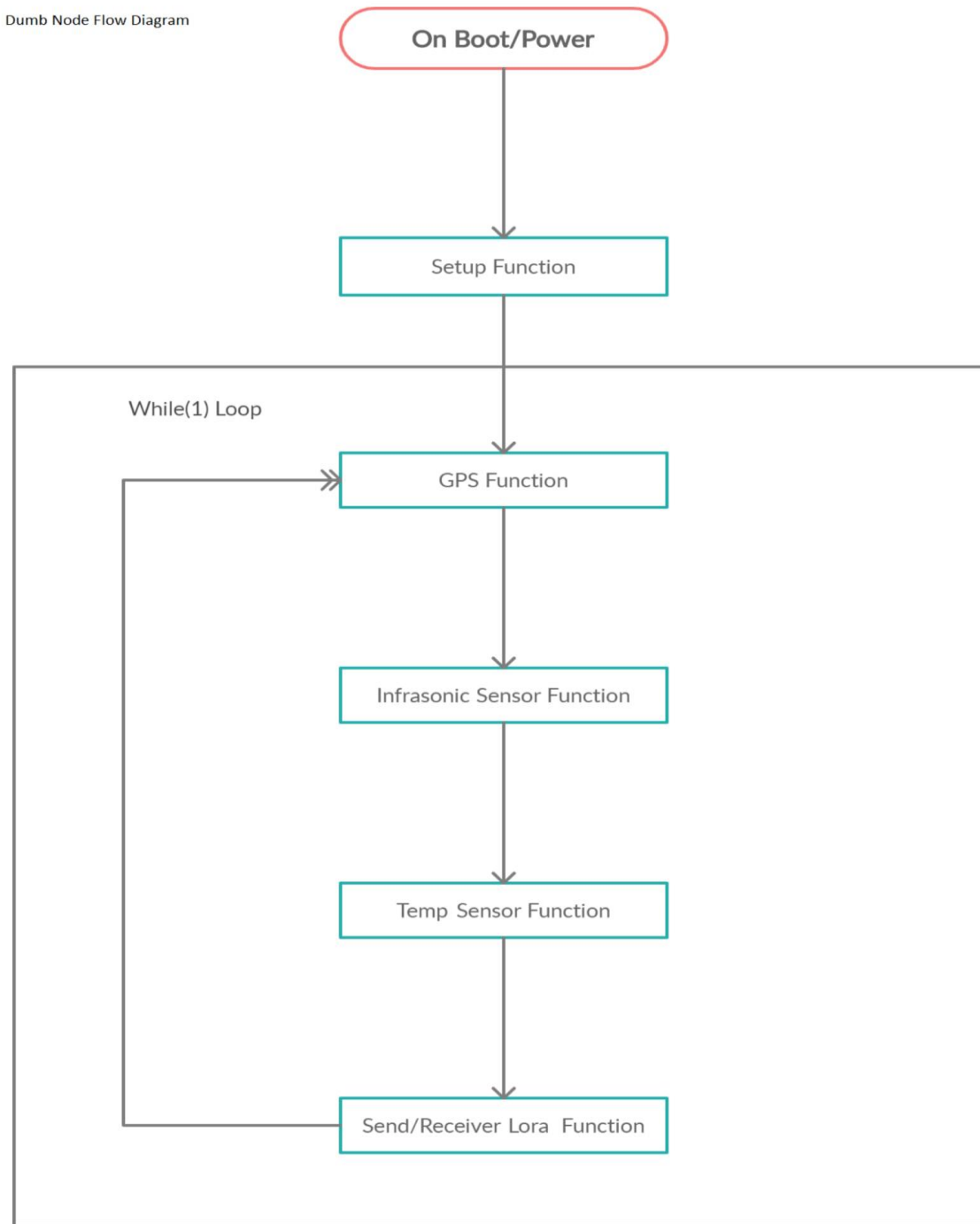

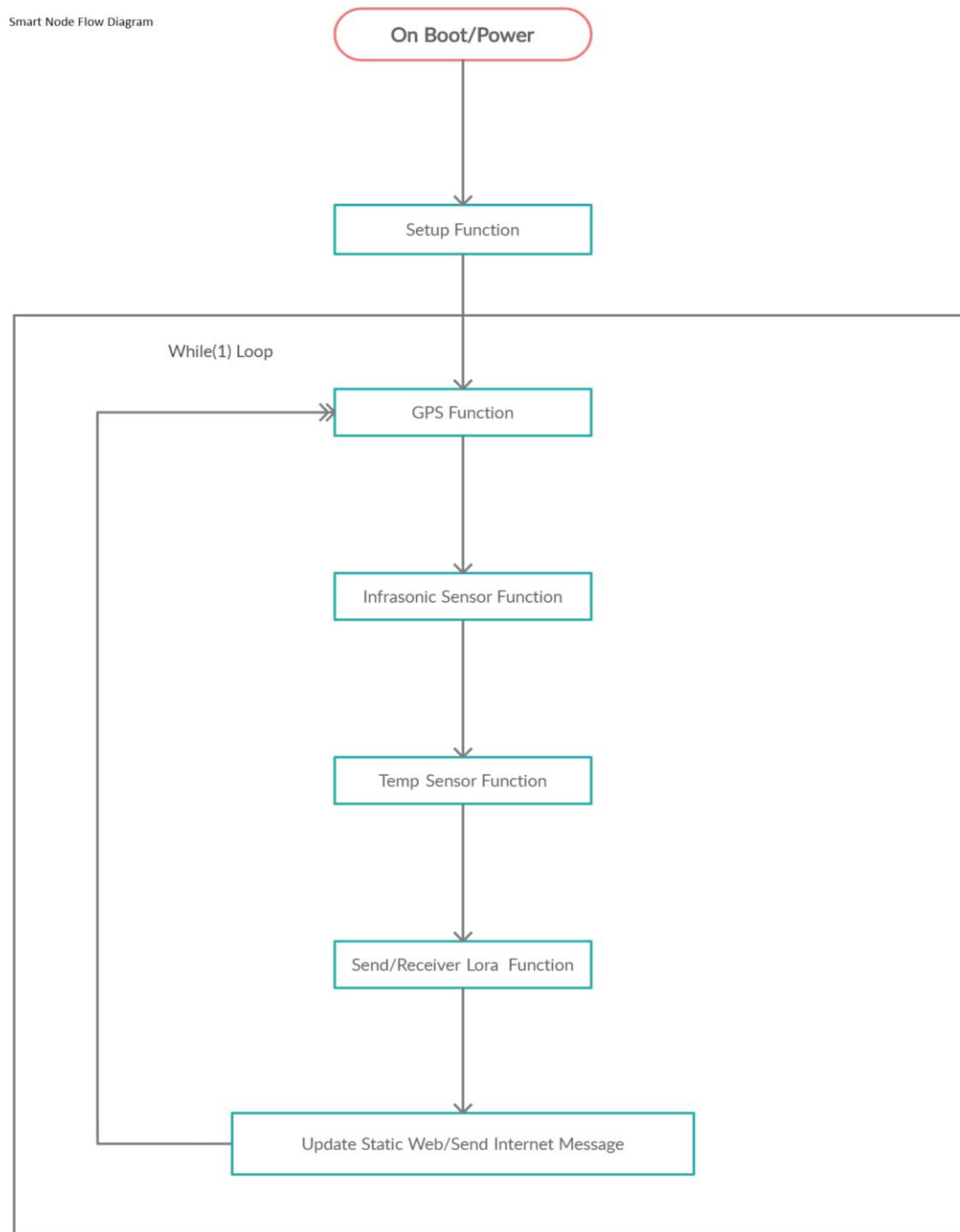

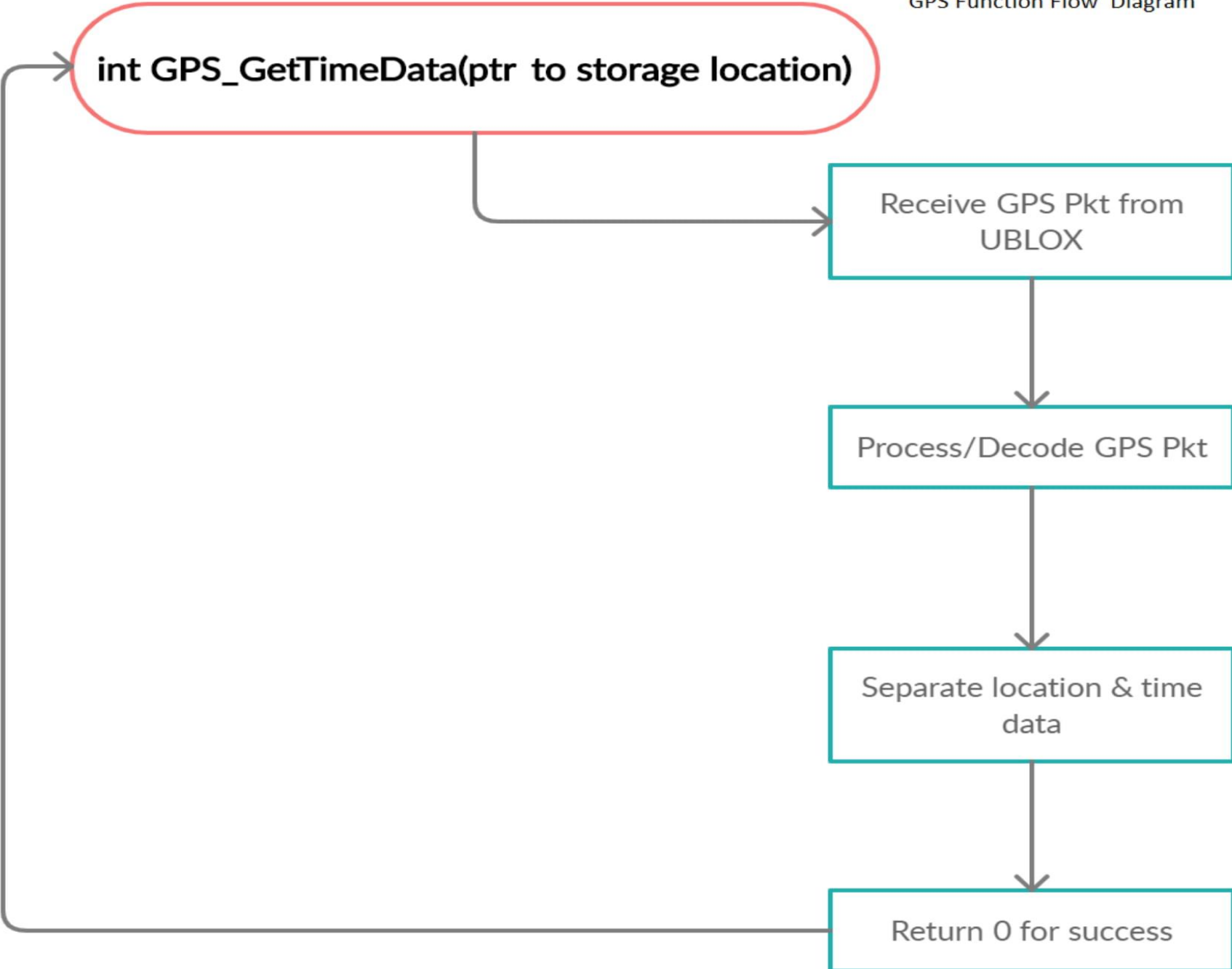

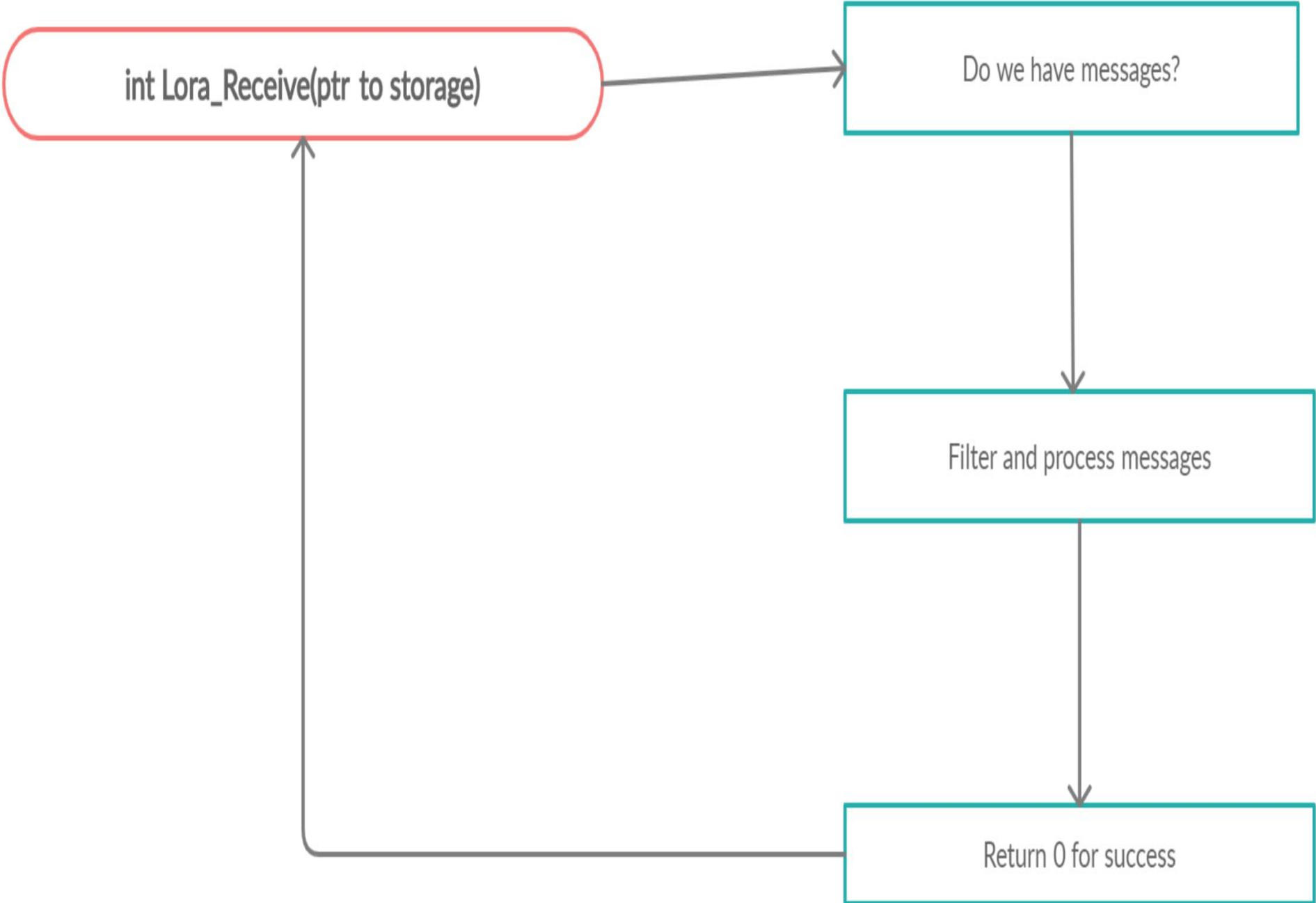

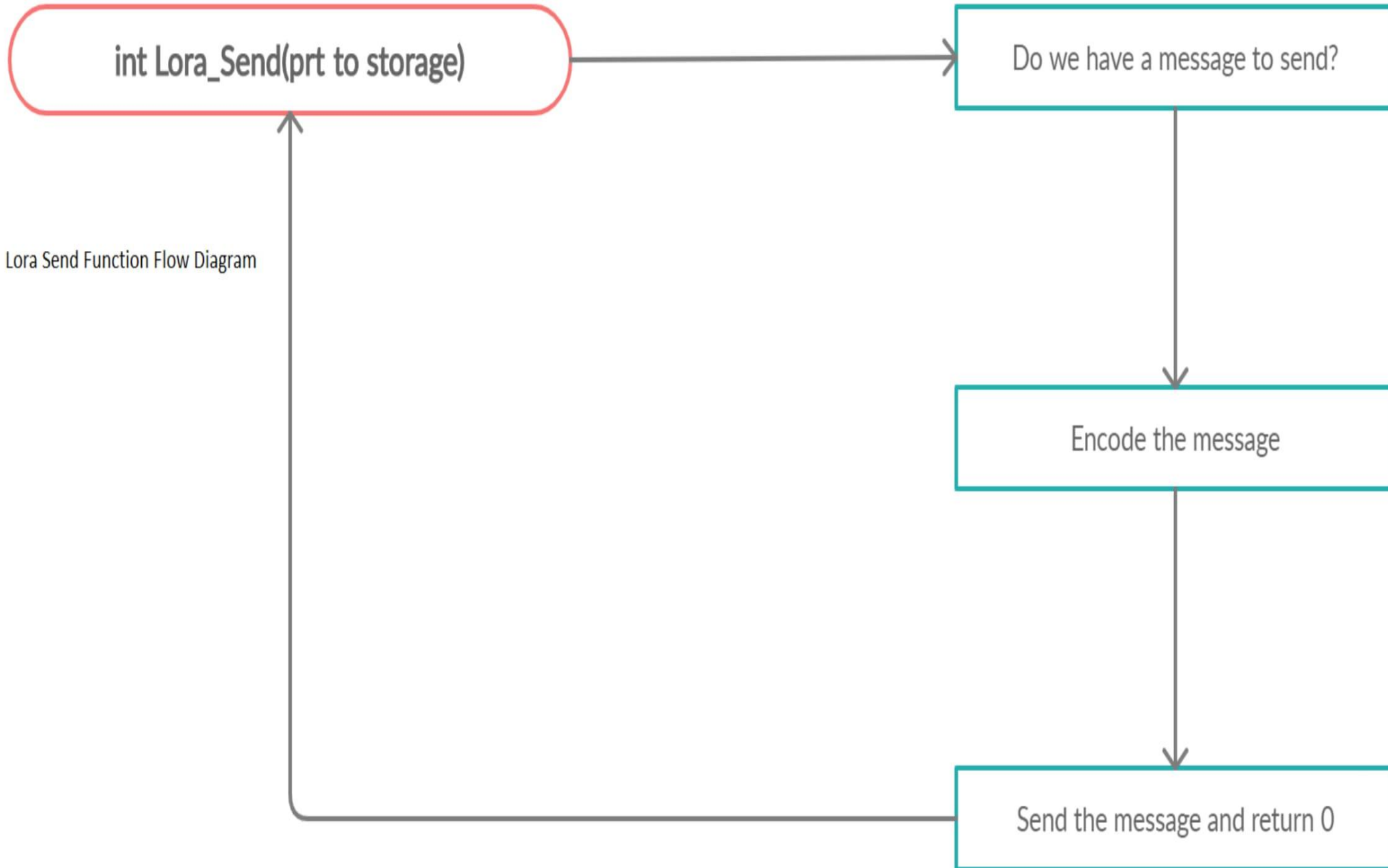

Lora Send Function Flow Diagram



int ADC\_Function()

Go & Read Buffers

Convert Values

Do some DSI



Option 1



Option 2



Option 3

**Message Type:**

What type of message are we receiving? Is it a temperature reading? Infrasonic sensor reading? Are you still there request?

**Sender ID:**

The sender ID is comprised of its MAC address (6 Bytes). It could be the lower or upper Bytes? Or all the Bytes?  
Sample MAC: DE:AD:BE:EF:12:34

**Origin ID:**

Same as the **Sender ID** except it can be all 0's. All 0's to indicate the message origin is the **Sender ID**. If it's set to anything else the message originated from another node.

**Payload Length:**

Bytes to indicate the length of the **Payload** in Bytes. For now we can use 1 Byte for a total of 256 possible values 0-255.

**Payload:**

The data being sent in Bytes. Amount is set by the **Payload Length**.

# Amplifier Demo

# Design Validation

<u>Senior Capstone Design</u>					
Project: <a href="#">Infrasonic Wildfire Detector</a>			Primary Author: <a href="#">FireWatch Team</a>		
Team: <a href="#">FireWatch</a>			Date: <a href="#">10/22/2020</a>		
<u>Design Validation Plan &amp; Results (DVP&amp;R)</u>					
Requirement	Test	Test Subject	Target Date	Result	Recommendation
Will survive a 20 foot drop.	Drop 20 ft and inspect.	Shell prototype with weight inside.	3/20/21	TBD	TBD
Will survive a 20 foot drop.	Solid Model Simulation	CAD model	11/30/20	TBD	TBD
Send Messages between 1 Smart Node and 1 Dumb Node	Generate random test messages to send between Smart and Dumb nodes. Keep a running count of messages sent vs received.	Smart, Dumb nodes	12/1/20	TBD	TBD
Send Messages between 1 Smart Node and 2 Dumb Nodes	Generate random test messages to send between Smart and Dumb nodes. Keep a running count of messages sent vs received.	Smart, Dumb nodes	12/8/20	TBD	TBD
Send Messages between 1 Smart Node and "The Internet"	Generate random test messages to send between Smart and Internet. Keep a running count of messages sent vs received.	Smart nodes	1/18/20	TBD	TBD
Infrasonic sensor can detect 1 - 5 Hz sound waves (crown fires)	Generate and detect an infrasonic sound wave	Infrasound Sensor	2/1/20	TBD	TBD
Infrasonic sensor can detect 1 kHz - 5 kHz sound waves (surface fires)	Generate and detect an infrasonic sound wave	Infrasound Sensor	2/1/2020	TBD	TBD
Bonus: Sensor detects an actual fire	Light a fire and see readings	Infrasound Sensor and Nodes	4/10/21	TBD	TBD



# Infrasound Sensor Testing

- Our plan is to generate infrasound using a function generator and a subwoofer
- We will feed the subwoofer low frequency signals and try to detect them with our infrasound sensor



# Project Management











# Future Plans

39

- Build sensor circuit on breadboard and test microphone capsules
- Design and Print PCB
- Drop Test 3D printed model
- Improve design and 3D print larger scale
- Testing and Code Validation
- Purchase Batteries and Test Longevity