

Insulation Study Final Report

Team: Austin Anderson, Xi Chen, Cameron Moore, Yue Yu

Advisor: Dr. Behnaz Rezaie

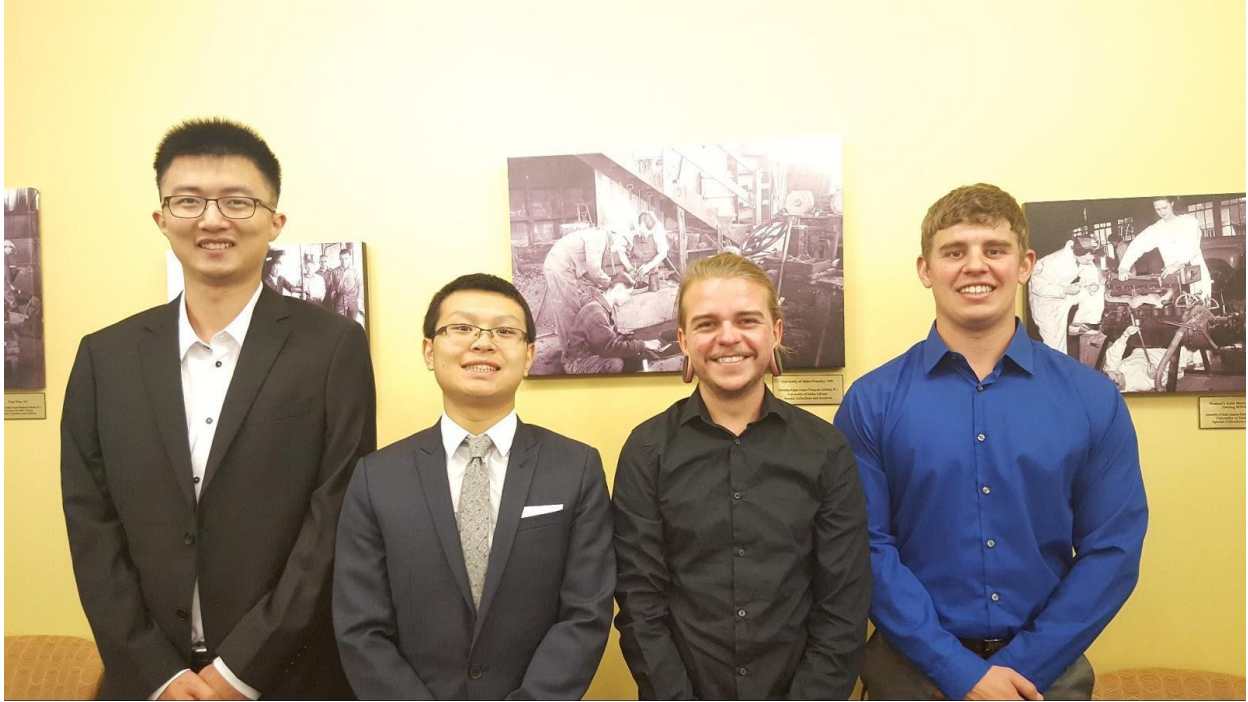

## Table of Contents

Executive Summary	3
Background	4
Problem Definition	5
Project Plan	7
Concepts Considered	8
System Architecture	10
Failure Mode Effects and Analysis	11
Conclusions and Future Work	12
Appendices	13

## **Executive Summary**

This team designed testing equipment to determine the effectiveness of different types of insulation. Three types of insulation were compared; aerogel, R\_max foam board, and carpet. HOBO temperature data loggers were used to gather temperature data from four locations. These locations were the testing equipment internal air temperature and surface temperature, as well as the external surface and air temperatures. Boxcar 4.3 data analysis program was used to program and deploy the HOBO sensors, offload HOBO data, and export data into an excel file. The rate of temperature decay was compared between

## **Background**

The capstone project has become an integral part of the education process at the University of Idaho allowing students to collaborate with companies from around the country on a variety of projects. Each sponsor different guidelines and expectations that simulate real engineering experience. This team's project was sponsored by the University, which allowed for a great deal of freedom in the scope of what the project entailed. A general method for testing the insulative properties of a variety of materials was desired. The possible use for the Senior Lab course in later semesters was another possibility. This opportunity allowed for a vast amount of research on similar studies, methods for collecting data and interpretation of the results.

Insulation materials are often accompanied by an R-value, which corresponds to the effectiveness of the insulation. However, it is not always easy to see how these different R-values affect the performance of an insulating envelope. Experimental data is required to directly compare the operation of different insulations. This team's project revolved around designing an experimental apparatus and performing an experiment. Gathering experimental data allows for further exploration into the effectiveness of different insulations. Increased understanding of insulation properties allows for more informed design choices.

## Problem Definition

Recent research has indicated that building energy loads are one of the primary consumers of energy. Most existing buildings in the U.S. were built before building energy efficiency was a concern, and most of these buildings will be in use for a considerable length of time. Due to buildings accounting for such a large energy demand, it is critical that efforts to minimize their heat loss be administered. A probable, and perhaps inexpensive way to lower the energy demand of buildings is to retrofit them with improved insulation. The alternative is to overhaul a great deal of existing buildings with state of the art HVAC networks, which can be expensive and intrusive.

This team aimed to characterize the performance of various types of insulation in order to provide experimental data from a simulated building insulation envelope. In order to reach the goal, the team needed to design a testing apparatus that could enclose the insulation as well as an internal heat source. An experiment to accurately measure the performance of each type of insulation was required.

The testing apparatus required several design options before finding the most effective option. The apparatus needed to be able to properly house several different types of insulation for testing. Additionally, it was required for the types of insulation to be easily changed. Making the insulation easier to change would reduce the efforts for each test and allow for more testing to be performed.

The table below outlines the specifications determined for the project. They define the type of equipment required and outline the expectations of the experimental setup.

<b>Attribute</b>	<b>Value</b>
<i>Sensor Temperature Accuracy</i>	+/- 1 Degree C
<i>Data Logging Capability</i>	Able to log and record reading every minute for 90 minutes, or duration of test.
<i>Test Specimens</i>	All test insulation must be equal thickness, or as close to equal thickness as possible
<i>Temperature Measurement</i>	<i>Temperatures will be recorded in three locations. One temperature sensor will record the ambient air temperature in the center of the box, Another</i>

<i>Locations</i>	<i>temperature will be recorded on the inside of the walls and on the surface of the test insulation. A third temperature measurement will be taken on the surface of the box.</i>
<i>Model Material</i>	<i>Model will be constructed using plywood and 2X2 wood framing. The goal is to replicate a residential home as closely as possible.</i>
<i>Size of Model</i>	<i>Model will be a cubic structure with an internal volume of approximately 8 cubic feet.</i>

Table 1: Project specifications are shown above. These values provided specific targets for the team to reach.

The box create temperature profiles for each type of insulation in order to establish a temperature gradient. The temperature gradient allowed for direct comparison to be made. Another deliverable was a comparison temperature decay over time inside a space enclosed by the insulation.

## **Project Plan**

This project has 4 team members: Austin Anderson, Cameron Moore, Yue Yu and Xi Chen. Their individual team roles are outlined below.

Austin is the project lead, mainly oversees the trajectory of the project direction, and takes responsibility of communication with clients and suppliers. He also makes is the primary point of contact with the instructor.

Cameron focuses predominantly on the project design. Such design includes drafting virtual models of the experimental setup as well as leading the Wiki-page composition.

Yue's duties revolve around data acquisition during the testing period, as well as maintenance of the sensors.

Xi's responsibility is mainly on the writing component of the project. This included the team's meeting minutes, PowerPoint presentations, and reports. Xi assists Yue on data acquisition as well as maintenance of the sensors.

The intended schedule of the project can be seen in the Gantt chart, found in Appendix C. The primary goal aimed to finalize all preparations for the model construction by February 11th, as it was the most difficult part of the project in terms of design. Data acquisition was planned to be the largest time investment. By March 4<sup>th</sup> (before Spring Break), the teams goal was to complete the data analysis. Time before the engineering EXPO was reserved for troubleshooting and other miscellaneous purposes.

The actual project implementation aligned quite closely with the original goals. There was some difficulty in acquiring our Aerogel insulation, which resulted in a slight delay for its testing. The testing period was found to indeed be the greatest time commitment. Two hours at the minimum were required for each test.

## Concepts Considered

The majority of design work was centered on the testing equipment.

### Design #1:

The original design was inspired from a similar project that is taking place in the Civil Engineering department on campus. The team occasionally worked with this team to learn more about certain insulation types and how they were proceeding on testing. The team took their idea and modified it to be more easily transported through various building doorways while still providing a stable testing environment. The idea was to have a two cubic foot box that was suspended several feet in the air. Each side panel of the box would be removable, allowing for various insulation types to be attached to the interiors for easy installation. Sensors would then be placed on both the interior and exterior of the box walls to measure the temperature profile for later calculations. Costs for construction would entail plywood, screws, wood framing, hinges, and wheels.

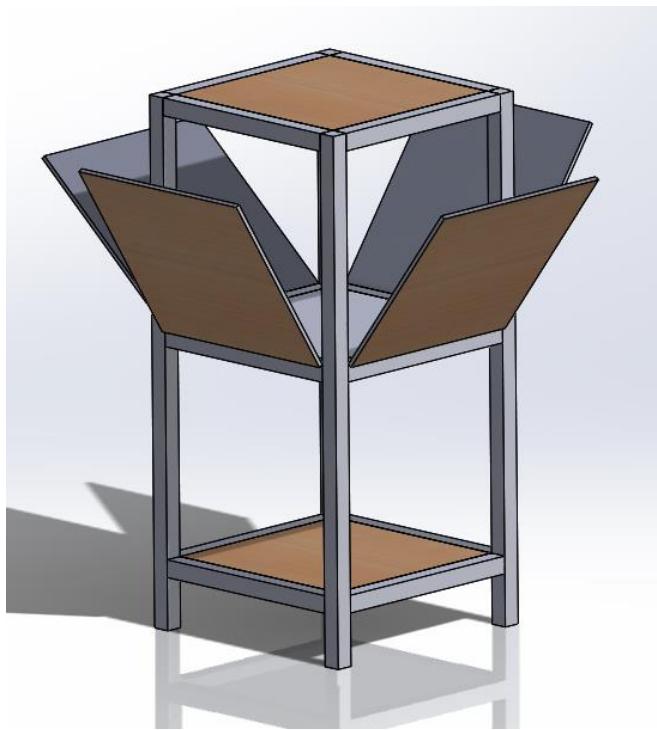

Figure 2: Early concept showing a custom built box with hinged panels to facilitate changing insulation.

### Design #2:

Instead of constructing a testing environment from scratch the team instead purchased an 18"x18"x18" shipping crate from an online company. This saved a significant amount of



funding which would be used to later on upgrade the base model. Construction time was able to be disregarded as the setup of the box took little time. Similar to the previous design, a thermocouple was placed on the interior wall surface along with an air temperature sensor. On the exterior surface another thermocouple would also be attached in order to get a temperature profile through the walls. There is also an ambient air temperature sensor that measures any fluctuation in the environment to ensure consistency. The box is lightweight, which makes it easily transported. It also is able to be easily assembled and disassembled on site. It was able to provide all the necessary functions of the required apparatus without the construction time costs.



Figure 3: Picture of purchased testing apparatus given by manufacturer.

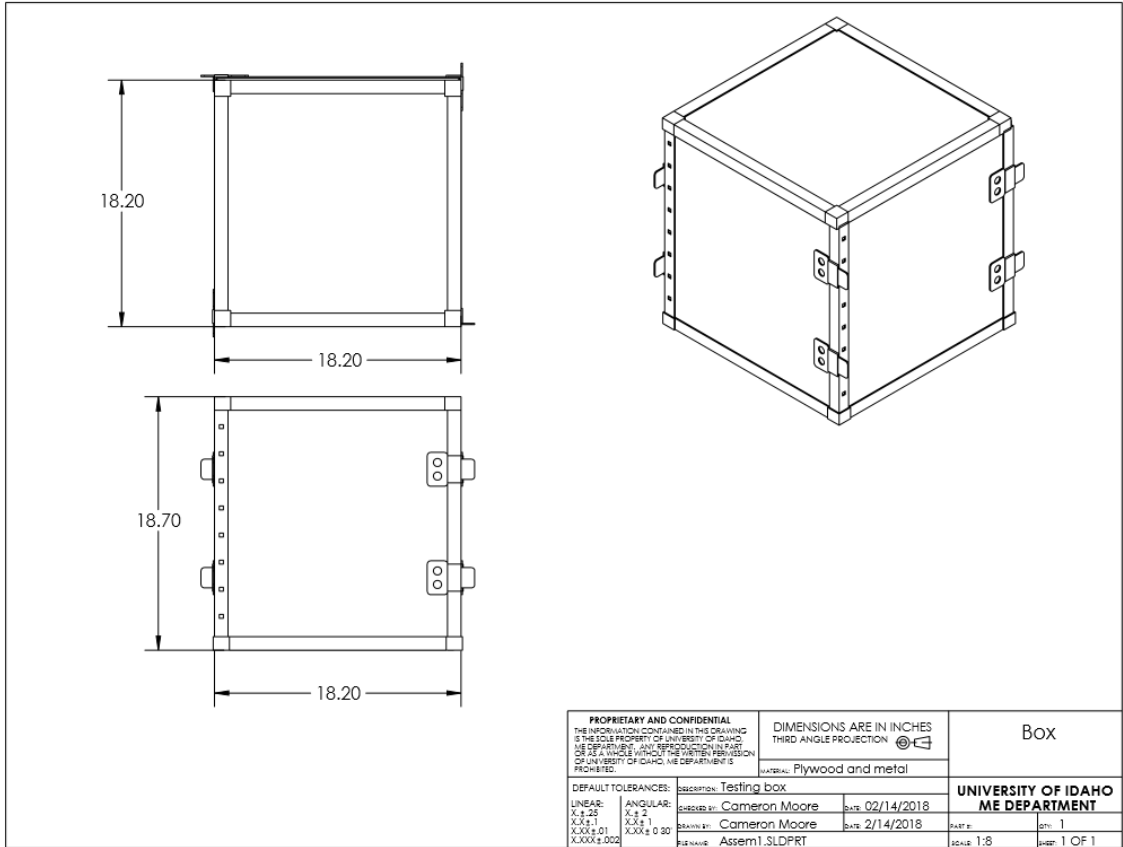

Figure 4: Custom drawings of test specimen.

### System Architecture

The system architecture was fairly simple. Temperature measurements of several critical locations on the box were needed. Materials and components used included a personal computer, two HOBO temperature sensors, a plywood box with dimensions of 18” x 18” x 18”, several candles for heating the box inside, and insulation materials including R max, Aerogel, and standard carpet. Gauss Johnson Engineering Lab room was chosen for the location of testing. The room featured stable indoor temperature and ventilation conditions, which allow for consistency between tests.

The testing procedure was to heat the box internally using two standard candles. In order to keep the candles lit for the duration of the test, twenty four holes were drilled into the box. Without the holes, CO2 would build up and the candles would extinguish themselves. Four holes were placed evenly on the bottom of each vertical side of the box, two holes were then placed on the top of each panel.

A total of four temperature sensors were used during each test. Two of these sensors were located inside the box. One measuring the air temperature inside the box, the other measuring the temperature of the inside surface of the box. Aluminum tape was placed over the sensors to reflect radiation effects. The outside of the box had a similar setup. One thermocouple was placed on the outside surface while the final sensor was an air temperature sensor measuring the ambient room temperature.

The temperature sensors were programmed using Boxcar, a complementary data logging software for the HOBO sensors on a PC. Boxcar allowed the team to initialize several parameters of the HOBOs. Such parameters include the sampling frequency and the starting time. It was a simple task to plug the sensors into the computer and provide the above values. Once the sensors were initialized, they could be placed in their respective locations as outlined above.

After the sensors are placed and initialized, the testing was able to proceed. The step consisted of lighting the two candles and placing them into the box. The box of the box is then sealed. A waiting period of around thirty minutes was then observed. Thirty minutes allows for heat transfer conditions within the box to reach steady state. Once this has been reached, the holes providing oxygen and removing CO2 can be covered and the candles extinguished shortly thereafter. An additional 60 minutes of waiting are observed. During this time, the heat within the box leaves and the temperature decreases over time. The HOBOs record this data.

After the culmination of the test, the results were offloaded from the sensors via Boxcar. The data was then exported to excel for analysis.

Data analysis consisted of plotting the temperature recordings from the sensors versus time to establish trends in their decay. Further analysis was performed by applying a curve fit to the decaying portion of the data. This portion is from when the candles were extinguished until the end of the test. A polynomial fit was generated to fit the data. The polynomial was then differentiated and plotted to establish how quickly the temperature was decaying for each material. The appendix shows data plots.

### **Failure Mode and Effects Analysis**

Potential Failure Mode	Potential Effect(s) of Failure	Severity (1-5)	Potential Cause(s)/ Mechanism(s) of Failure	Occurrence (1-5)	Current Process Controls
Delayed heat source termination	Inaccurate data acquisition	2	Negligence	3	Human Caution
Fell off from Velcro	Damage Insulation/Fire Hazard	4	Weak Velcro	1	Replace with stronger means of attachment
Fell off on heat source	Damage Sensor	5	Weak Sensor Attachment	1	Replace with stronger means of attachment
Physical Impact	Damage Wooden Frame	4	Negligence	2	Treat with care

Heat Source terminated prematurely	Inconclusive Data	1	Lack of ventilation	3	drill more air hole
------------------------------------	-------------------	---	---------------------	---	---------------------

### Conclusions and Future Work

The team has provided all of its deliverables. First, a reusable testing apparatus was obtained. This box allows for insulation to be easily changed. Second, temperature data was obtained for several types of insulation. Several trials were administered for each type of insulation. Third, graphs showing temperature distribution and temperature decay were created using temperature data.

Several trends were identified during testing. The interior surface of the box reached a steady state temperature more quickly than the internal box air temperature. This was likely due to radiation effects from the candle. Once steady state conditions were reached and the candles extinguished, the internal surface temperature began to decrease more quickly than the internal air temperature. This was expected as the temperature gradient between the internal and external surfaces was high, meaning a higher rate of heat transfer would occur.

Once the candles were extinguished, the temperature began to decay as expected. The team was interested in comparing how quickly the temperature dropped for each type of insulation. A comparison was made between 100 °F and room temperature. These graphs can be seen in appendix B. It was observed that the temperature dropped more quickly in the R\_max foam board. The carpet was found to have the slowest decline in temperature.

The team compared the slopes of the temperature decay to get a closer look at how quickly the temperature dropped per second. Once again, the carpet had the slowest temperature decay while the R\_max foam had the highest, with aerogel being in between.

The R-value of aerogel tested is around 3.79 [h-ft<sup>2</sup>-F/Btu] while the R\_max was listed as 3.2 [h-ft<sup>2</sup>-F/Btu]. Therefore it was expected that the aerogel outperform the R\_max. The caret, however, did not come with an R-value. Based upon the results of the aerogel and R\_max. The R value of the carpet is likely higher than the aerogel. The carpet was also thicker than the other two materials, therefore making it difficult to accurately determine how effective an equal thickness of carpet would be.

The experiment can be improved through the use of a more consistent heat generation source. A hair dryer or portable resistance heater placed inside the box would likely provide a more consistent result, which would allow for easier comparison. Many additional materials can be tested to widen the scope of the project. Another source of improvement could be the implementation of additional thermocouples located in between the different layers of insulation. Knowing the temperature in more locations would increase the amount of knowledge available on the heat transfer.

Continuation of this project would allow future students to become familiar with thermocouples and air temperature sensors as well as improving coding skills through MatLab or other computational programs. This would be an excellent project for ME 430 senior lab.

## **Appendix A: Testing Results**

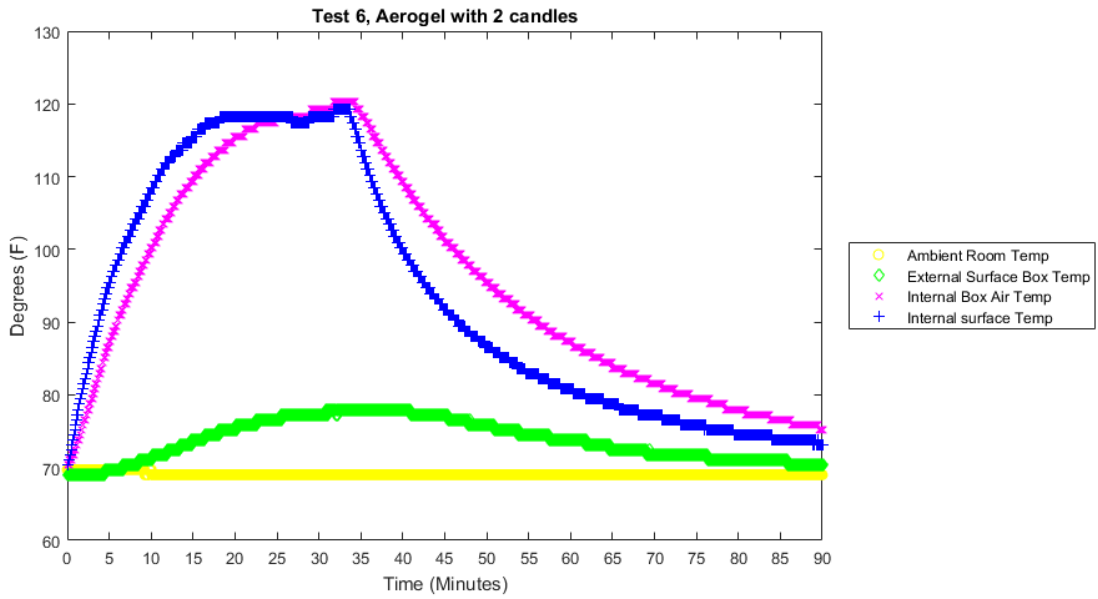
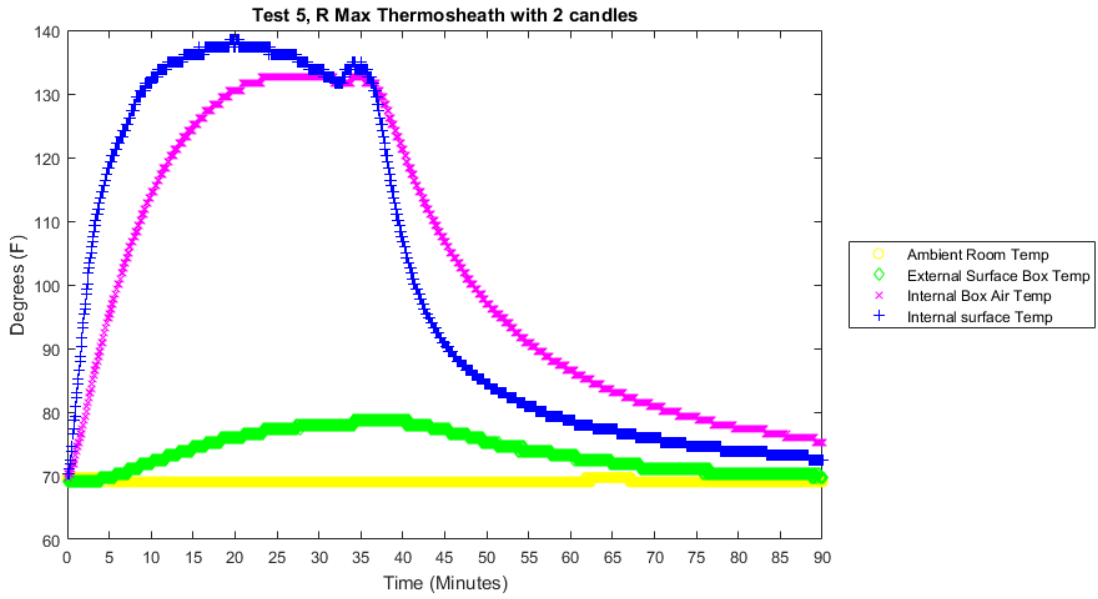

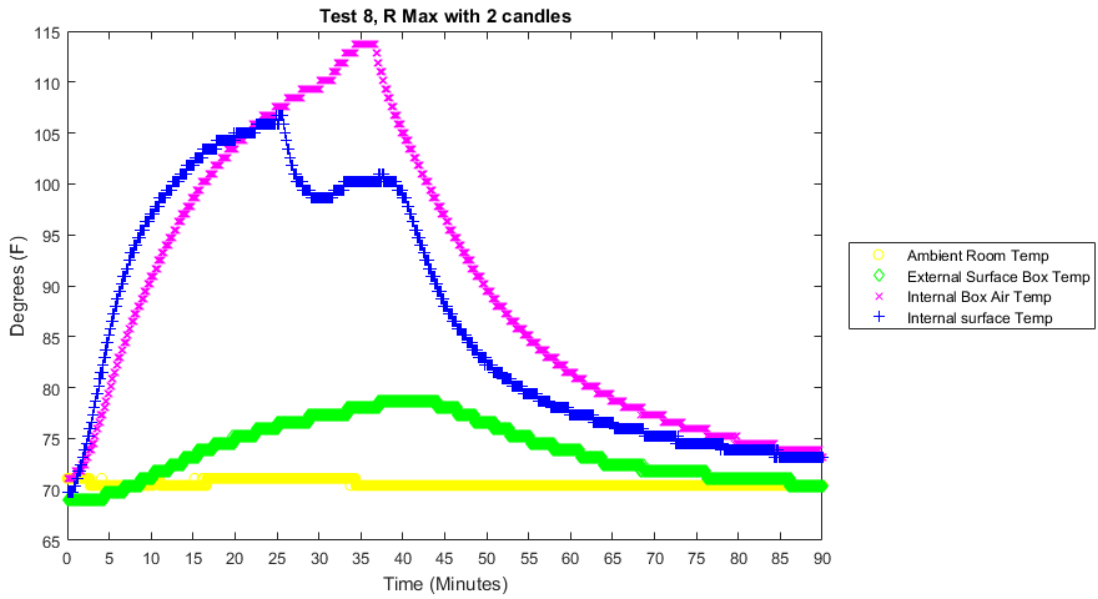
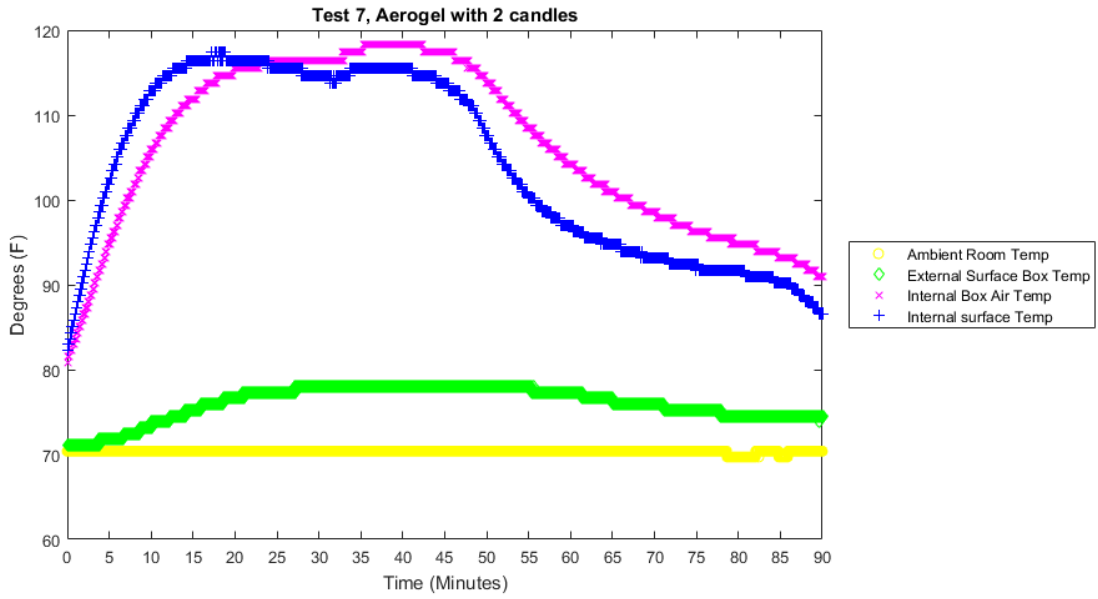



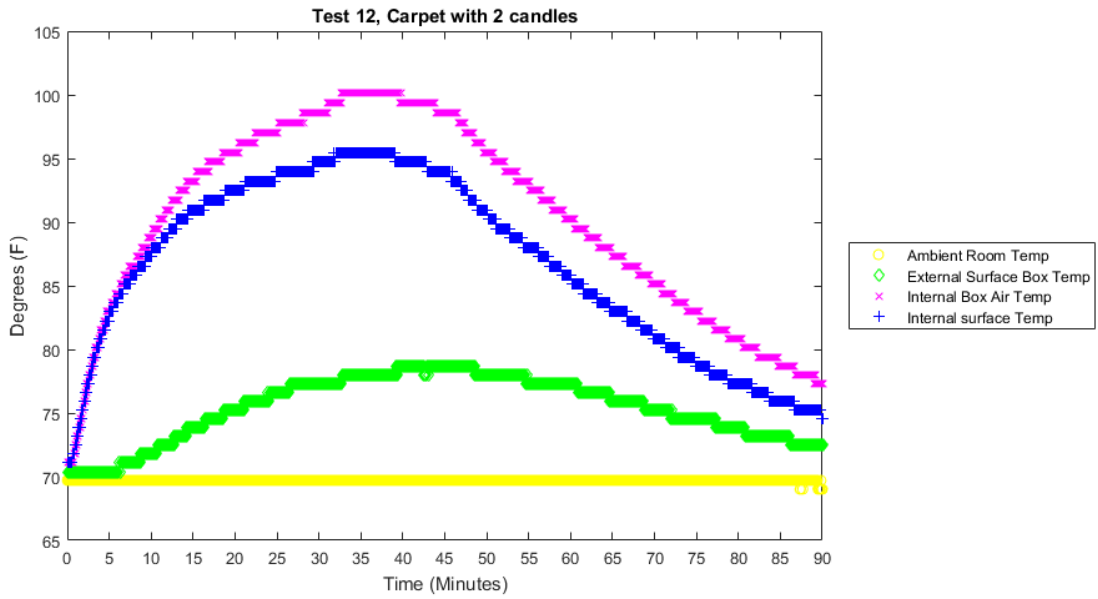
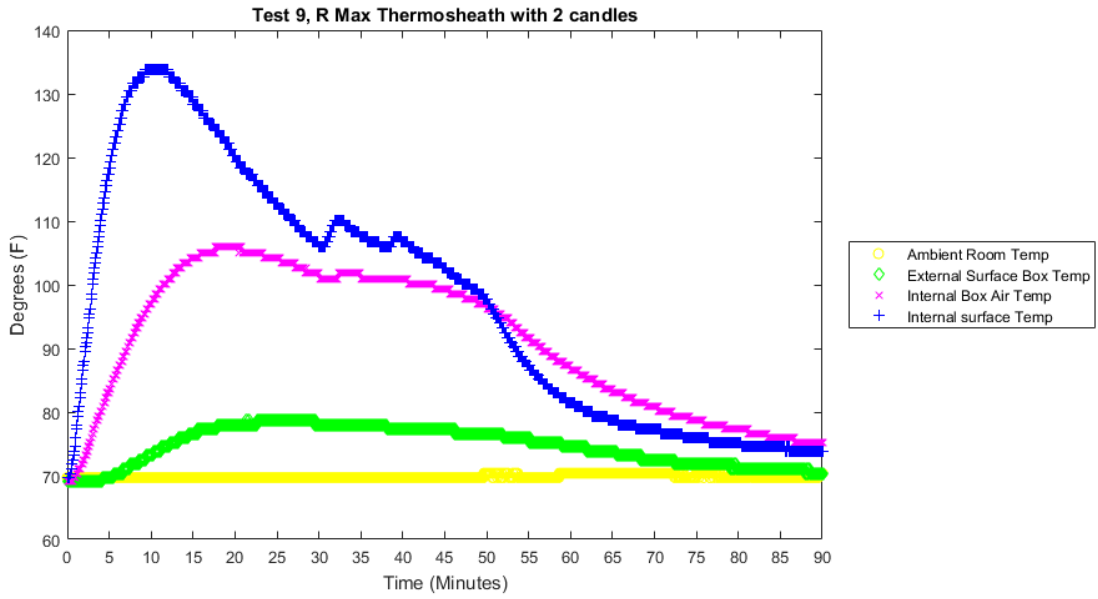

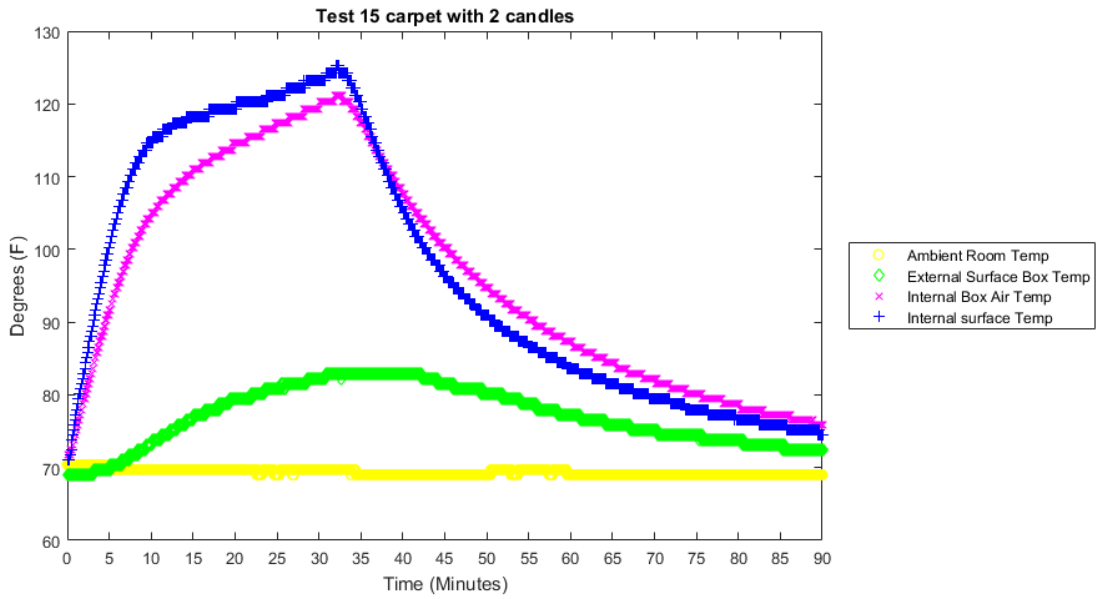
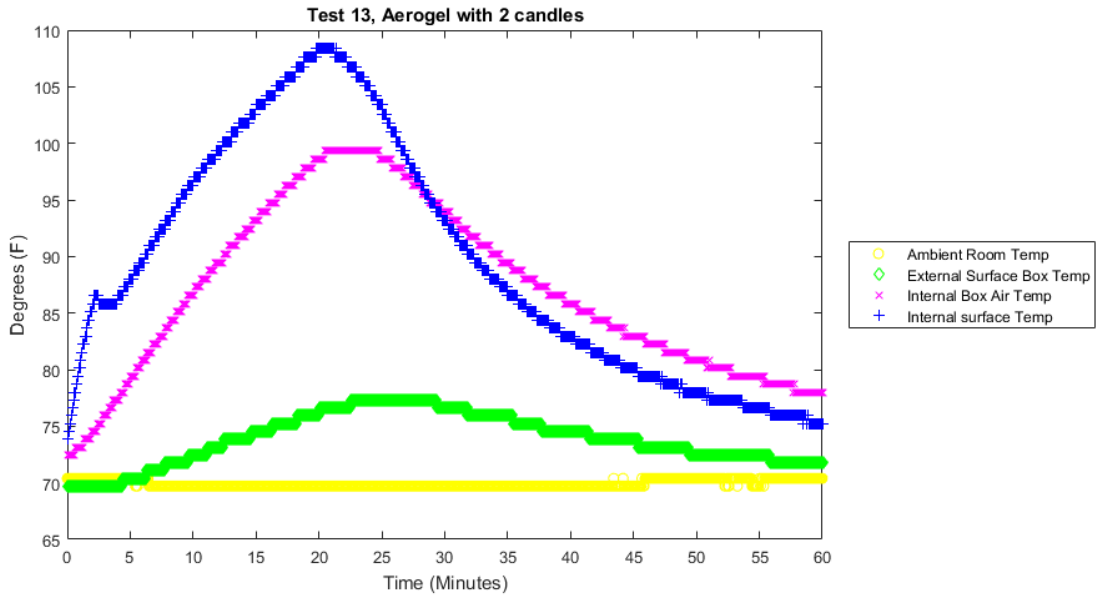

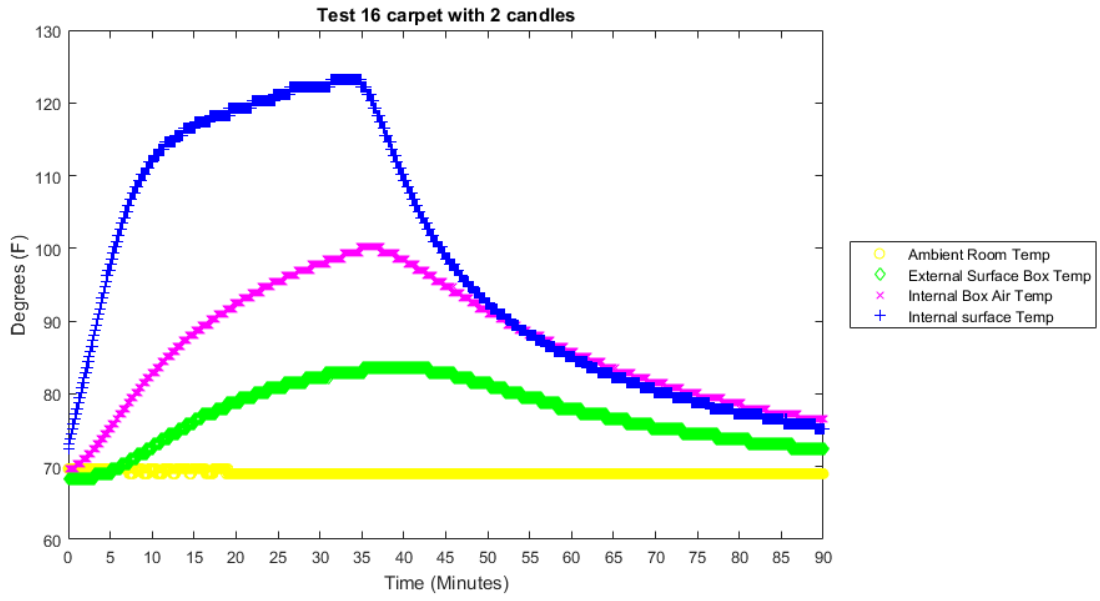

## **Appendix B: Comparison Analysis**

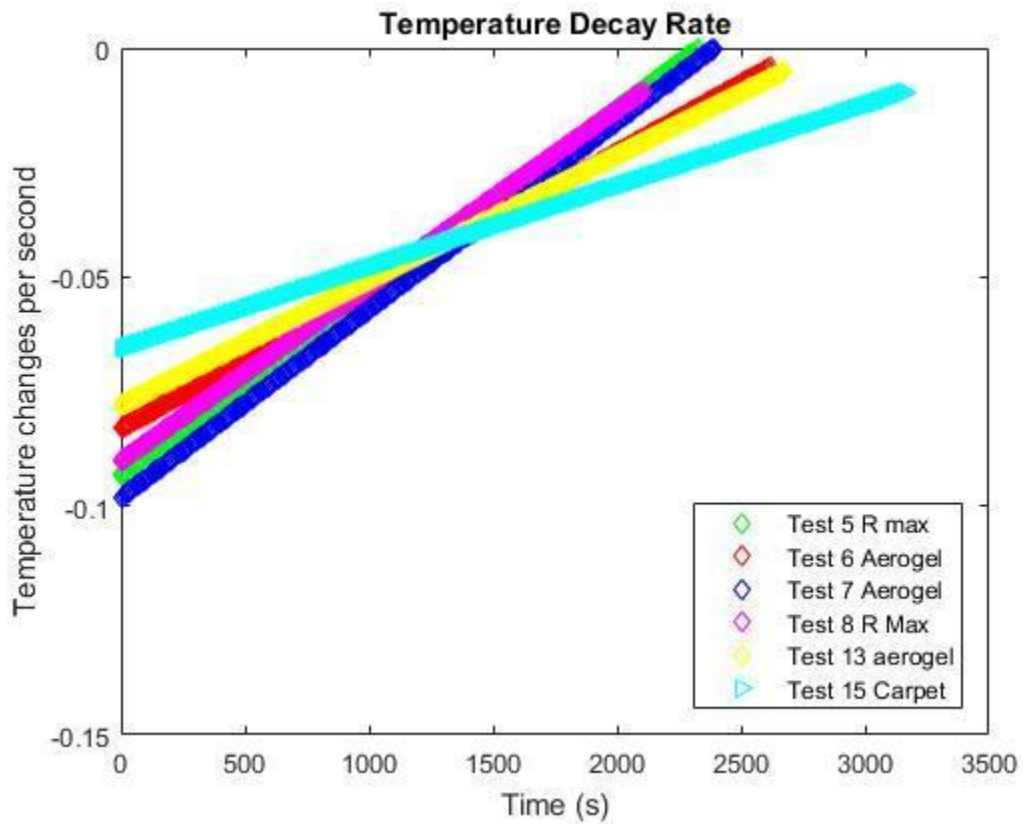
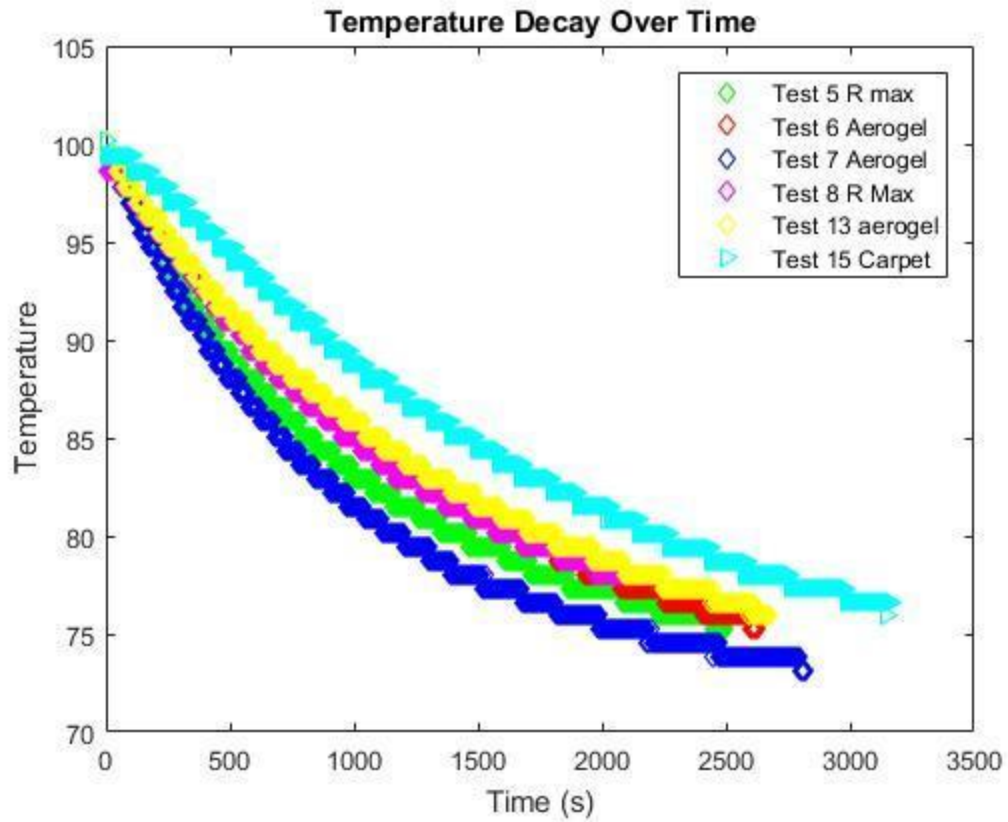

# Appendix C: Gantt Chart

