

GENIUSTM

Lighting Control Software

Operator's Manual



Document No.: 85011 (A86) Issue: 2 Date: Apr..1994
--

Offices and Service Centres

Asia:	7th Floor Corporation Sq., 8 Lam Lok St., Kowloon Bay, Kowloon, Hong Kong
	Tel: (852) 757 3033 Fax: (852) 757 1767
Canada:	2430 Lucknow Drive, Unit 15, Mississauga, Ontario L5S 1V3 Canada
	Tel: (1) 905 677 7130 Fax: (1) 905 677 6859
France:	26 Villa Des Fleurs, 92400 Courbevoie, Cedex, France
	Tel: (33) 1 47 88 66 66 Fax: (33) 1 43 33 71 75
Germany:	Salzbergstrasse 2, 38302 Wolfenbuttel-Salzdahlum, Germany
	Tel: (49) 5331 30080 Fax: (49) 5331 78883
Italy:	Via delle Gardenie 33 (Pontina Vecchia Km 33,400), 00040 Pomezia Roma, Italy
	Tel: (39) 6 914 7123 Fax: (39) 6 914 7136
U.K.:	Grant Way, Isleworth, Middlesex, TW7 5QD, U.K.
	Tel: (44) 081 560 3171 Fax: (44) 081 568 2103
USA:	PO Box 9004, 18111 South Santa Fe Avenue, Rancho Dominguez, CA90221, USA
	Tel: (1) 310 637 7500 Fax: (1) 310 632 5519

The material in this manual is for information purposes only and is subject to change without notice. Strand Lighting assumes no responsibility for any errors or omissions which may appear in this manual. For comments and suggestions regarding corrections and/or updates to this manual, please contact your nearest Strand Lighting office.

El contenido de este manual es solamente para información y está sujeto a cambios sin previo aviso. Strand Lighting no asume responsabilidad por errores o omisiones que puedan aparecer. Cualquier comentario, sugerencia o corrección con respecto a este manual, favor de dirijirlo a la oficina de Strand Lighting más cercana.

Der Inhalt dieses Handbuches ist nur für Informationszwecke gedacht, Aenderungen sind vorbehalten. Strand Lighting uebernimmt keine Verantwortung für Fehler oder Irrtuemer, die in diesem Handbuch auftreten. Für Bemerkungen und Verbesserungsvorschlaege oder Vorschlaege in Bezug auf Korrekturen und/oder Aktualisierungen in diesem Handbuch, moechten wir Sie bitten, Kontakt mit der naechsten Strand Lighting-Niederlassung aufzunehmen.

Le matériel décrit dans ce manuel est pour information seulement et est sujet à changements sans préavis. La compagnie Strand Lighting n'assume aucune responsabilité sur toute erreur ou omission inscrite dans ce manuel. Pour tous commentaires ou suggestions concernant des corrections et/ou les mises à jour de ce manuel, veuillez s'Il vous plait contacter le bureau de Strand Lighting le plus proche.

Manual and Software Copyright 1994, Strand Lighting Limited. All rights reserved.

Information contained in this document may not be duplicated in full or in part by any person without prior written approval of Strand Lighting. Its sole purpose is to provide the user with detailed operational information for the equipment supplied. The use of this document for all other purposes is specifically prohibited. Certain features of the equipment described in this document may form the subject of patents or patent applications.

Genius™ Kaleidoscope™ Communiqué™ are registered trademarks of Strand Lighting Limited.

Safety Information



Warning

LBX models are direct mains driven, GSX models operate from a mains driven low voltage power Supply unit.

This equipment is designed and manufactured to comply with international safety standards IEC65 and is intended for use as part of a lighting control system. It must not be used for other purposes where there is a safety risk to any person. There are no user serviceable parts and only suitably qualified personnel should be engaged to remove covers or panels from the consoles.

- **Avoid** liquid spillage onto the console. If this should occur, switch off the system immediately.

Table of Contents

Offices and Service Centres	ii
Safety Information	iii
Glossary of Terms	x
Abbreviations.....	xiii
1. Welcome to Genius	1
About this Manual	1
Getting Help	2
Registering Your Software	2
Messages.....	2
2. Setting up the Console	3
Unpacking	3
GSX Console Overview.....	4
Connecting the Power supply	5
Connecting the Monitor	5
Connecting a Printer	6
Connecting the Dimmers.....	7
3. Software Installation	9
Operating Software	9
Application Software.....	9
Switching on.....	10
Cold Start	10
Warm Start.....	10
Loading Operating Software.....	11
Loading Application Software.....	13
Registration and Passwords	14
Registration	14
Entering Your Password	15
What Happens if I Don't Register?	16
Upgrades.....	16
Displays and Menus	16
Output Screen	17
Set-up Screen	18

Menu Editing	19
System Options	19
Set-up Options	19

4. Quickstart Tutorial.....21

The Keypad & LCD.....	22
Navigating the Displays.....	23
The Wheel and Cursor keys	23
Lighting your first show	25
Cues.....	25
Entering & Controlling a Channel	25
Setting up a Cue.....	26
Recording Cues For The show.....	27
Playing Back Cues	30
Using Submasters.....	31
Setting up a Basic Effect	33
Running the Effect.....	35
Saving a Show to Disk	36

5. Channel Control.....37

Command Modes	37
Level Entry Formats.....	37
Direct Action Mode.....	37
Command Line Mode	38
Selecting Channels & Setting Levels	38
Combination Entries	39
Invalid Key Entries	40
Current Selection	41
Channel Level Activity.....	42
Advanced Channel Control.....	42
Stage Output	42
Solo	43
Remainder Dim.....	43
Bump Keys	43
Save Key.....	44
Controlling Cues in Channel Control	44
Proportional Vs Shaft Mastering.....	45
Shaft Mastering	45
Proportional Mastering	45

6. Recording Cues47

Selecting a Cue	47
Entering Commands	47
Direct Action Mode	47
Command Line Mode	47
What is a Cue?.....	48
Recording a Cue.....	48
Recording Cues with Time	49
Entering Time Values.....	49
Types of Fade.....	50
Crossfade.....	50
Movefades	51
Movefade to Zero.....	51
Updating a Cue	52
Time Key Options	52
Split (/).....	52
Wait	53
Delay	54
Cue Preview Screen.....	55
Cue Sheet	56
Selecting Cues	56
Screen Editing	56
Changing Recorded Levels	57
Changing Recorded Times and Fade Times	57
Copying cues	58
Links and Loops	58
Links, Loops and Chases	59
Deleting Cues	60
Renumbering Cues	60
Xref Screen.....	61

7. Playbacks63

X Playback.....	64
A/B Playback	67
LOAD A.....	67
LOAD B.....	67
A/B faders	67
Running Fades Together	69
Blackout Key.....	69
Grand Master.....	69

8. Submasters	71
Recording	72
Setting Times	73
Previewing	74
Fields	75
Clearing	75
Flashing up	75
Updating	76
Advanced Submaster use	76
Inhibitive Submasters	76
Triggering Macros	77
Submaster Examples	77
9. Patch	79
Scaling	80
Default Patch	81
Live/Preview Patches	82
Editing Patches	82
Patching Dimmers	83
Patching Non dims	83
Unpatching	83
Example Patch Screen	84
10. Basic Effects	85
Recording	85
Effects Sheet	87
Example Effects	87
Loading / Running Effects	88
Starting / Stopping Effects	89
Changing Running Effects	89
Updating Effects	90
Deleting Effects	91
FX Master	91
11. Macros	93
Built - in Macros	93
Recording User Macros	95
Example Macros	96
Triggering User Macros	98

12. Archive Screen.....	99
Clear Menu.....	100
Print Menu.....	101
Disk Menu	102
Loading Saved Shows.....	102
Formatting Disks.....	102
13. LBX	105
Operational Modes.....	106
Auto Hold.....	107
Zero Pick up Point.....	113
C/D Fade Times.....	113
C/D Flash Modes	113
Using with Playbacks, Submasters and Channel Control	114
Stealing a Channel	114
14. Errors / Faultfinding	115
Error log	115
Trouble shooting	117
Error messages.....	118
15. Designers Remote	121
Connecting Up.....	122
Appendix A Reference	125
Output Screen.....	125
Channel Window Colours.....	125
Setup Screen.....	126
Setup Options	127
Help Screen	129
Menu / Screen Flow Chart.....	130
Command Descriptions.....	131
Editing Screen Fields.....	138

Appendix B - Connectors / Pin-out tables139

Power Connector.....139
DMX512 OUT.....139
SMX(Europe only).....139
AMX192.....139
D54.....139
RS 232.....140
VGA.....140
Audio input.....141
Designers Remote141

Index143

User Macro Sheet

Panel Layouts Pull - out

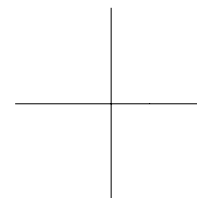
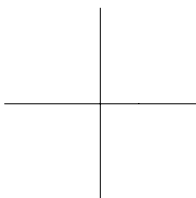

Glossary

Archive	Transfer of recorded data to, or from, the console to its disc or printer.
Auto Go	Automatically starts the next Cue on completion of the current Cue.
Bump Key	A key associated with sub-masters, when activated will 'flash' the contents to a level set by the level master fader.
Blind Editing	Editing which does not affect the stage Output, (see Preview).
Channel	An individual control path which is used to set or modify the level or colour of one or more luminaires.
Channel Level	Values displayed as: 0 to 99 and FL (FULL). Level can be entered as single digit (1 = 10%) or double digit (10 = 10%) - selectable within Set-up.
Channel Number	Each lighting channel on GSX has a unique number.
Colour Scroller	Device fitted to luminaires that allows changing of colour filters by remote control.
Command Line	Method of operation, selectable in Set-up mode, whereby key sequences are entered in order to construct a grammatical instruction. These instructions have to be terminated by the enter key before taking affect.
Colour Channel	Channel for controlling colour scrollers.
Crossfade	A fade containing both an up-fade and a down-fade where all the channel levels of one lighting state are replaced by the channel levels of another.
Cue	A Cue is stored data for both colour and Intensity channels and also contains other data relating to the transitional fade from the previous cue.
Cue 0	Is always a blackout.

Current Selection	The current selection is under direct Channel Control and highlighted in red on the Output screen.
Default	A factory (or user programmed) setting.
Dimmer	A device that controls the brightness of one or more luminaires.
Dipless Crossfade	A Crossfade in which channel levels progress linearly from start to finish. Channels at the same level before and after the fade do not change.
Direct Action	Method of operation, selectable in Set-up mode, whereby key sequences have an immediate affect on the output.
Down Fade	The down fade is the portion of a fade which involves only channels which are decreasing in level.
Effect	A repetitive sequence of lighting states that may be played back in a variety of different ways.
Fade	A gradual replacement of channel levels from one set of intensities to another.
Grand Master	A control that masters all the lighting channel levels irrespective of their source. Colour channels are not affected by the Grand Master.
Gel	Coloured film used in colour scrollers or individual luminaires.
Intensity Channel	Channel for controlling dimmers.
Live	Live implies that any changes will alter the output.
Macro	A macro enables a sequence of key presses to be recorded and then played back.
Memory Lock	Memory Lock prevents any recorded data from being altered but does not stop normal control or playback.
Movefade	A lighting change in which channels are added to, or removed from, the existing lighting state.

Non-Dim	Channel that remains off until a predetermined control level is reached, at which point it will turn fully on.
Output	The output, always refers to the actual dimmer levels.
Patch	Defines the relationship of dimmers to channels. There are two patches, one LIVE and the other PREVIEW.
Preview	Preview implies that any changes will not alter the output. ie in the Preview Cue screen, any changes will not be live on the output (ie Blind).
Proportional Mastering	When controlling more than one channel, channel levels are increased or decreased by the wheel in percentage terms.
Record Lock	See Memory Lock .
Remainder Dim	Causes the Current Selection to remain at their selected levels and all others to go to zero.
Shaft Mastering	When controlling more than one channel, channel levels are increased or decreased by the wheel in absolute terms i.e. the same number of 'points' is added to, or subtracted from, each channel.
Solo	A facility for temporarily inhibiting the levels of all channels that are not currently selected, allowing the selected channels to become the current lighting state.
Submaster	Faders allowing manual control of specific channels or groups of lighting level memories.

Abbreviations

AMX	U.S.I.T.T. standard (AMX 192) for the analogue multiplex transmission of dimmer levels. Max. 192 dimmers.
D54	A Strand Lighting standard for the analogue multiplex transmission of dimmer levels. Max.384 dimmers.
DMX	U.S.I.T.T. standard (DMX 512) standard for the digital multiplex transmission of dimmer levels. Max. 512 dimmers.
HTP	Highest-Takes-Precedence. Used when referring to lighting levels, whereby if a channel level is set by two or more parts of the control the highest level takes priority.
LCD	Liquid Crystal Display. The graphical display built in to the control panel is an LCD.
LED	Light Emitting Diode.
LTP	Latest-Takes-Precedence. Used when referring to control of lighting levels, whereby if a channel is set by two or more control actions, the latest one used takes priority.
LoTP	Lowest-Takes-Precedence. Used when referring to control of lighting levels, whereby if a channel level is set by two or more parts of the control, the lowest level takes priority.
MUX	(Multiplex) Means of transmitting dimmer level data down a single signal cable.
MIDI	Musical Instrument Digital Interface. An electrical and communications standard.
MSC	Midi Show Control.
U.S.I.T.T	United States Institute of Theatre Technology
VGA	Video Graphics Array. IBM video display standard.
VDU	Visual Display Unit, i.e. monitor screen.

Notes

Getting Help

For assistance, contact your local Strand Lighting dealer, or otherwise telephone one of the Strand Lighting offices given in the front of this manual.

Registering Your Software



Caution

When first installed, GSX and Genius are fully operational with your purchased configuration for a period of 21 days, after which certain features will become inhibited. During this period you must register your system with the **Software Registration Centre** at Strand Lighting U.K.

A password is then issued.

This is then typed in via the console's keypad making your particular system fully operational permanently.

This Password is exclusive to your system and is not transferrable.

The software packages are specific to individual consoles and it is not possible to load software disks into more than one GSX or LBX

Full details of registration and password entry is covered in the **Software Installation** chapter.

Messages

A single tone (beep) will be heard if an entry has not been accepted on the console and an error message will appear on the VDU.

A two tone beep will be heard and a message displayed in the VDU where an entry is required to be confirmed or cancelled.

Setting up the Console

This chapter gives you an overview of GSX and tells you how to connect up to power and install ancillary equipment such as dimmers, the monitor, and printers.

Unpacking

Carefully remove packaging and check the contents as listed, please inform your Strand dealer if any item is missing.

GSX Console

- Power Supply unit
- 1 x DMX cable (US only)
- Factory Test Summary
- Safety Leaflet

LBX Console

- 3 x Power Leads (Europe, U.S, English)
- 1 x DMX cable (US only)
- Factory Test Summary
- Safety Leaflet

Genius Software Pack

- Operator Manual Binder
- Genius Operator Manual
- Registration Card
- Operating Software disk
- Application program disk

GSX Console Overview

The figures below show the location of all keys and input / output ports on GSX. (For LBX overview see Chapter 13).

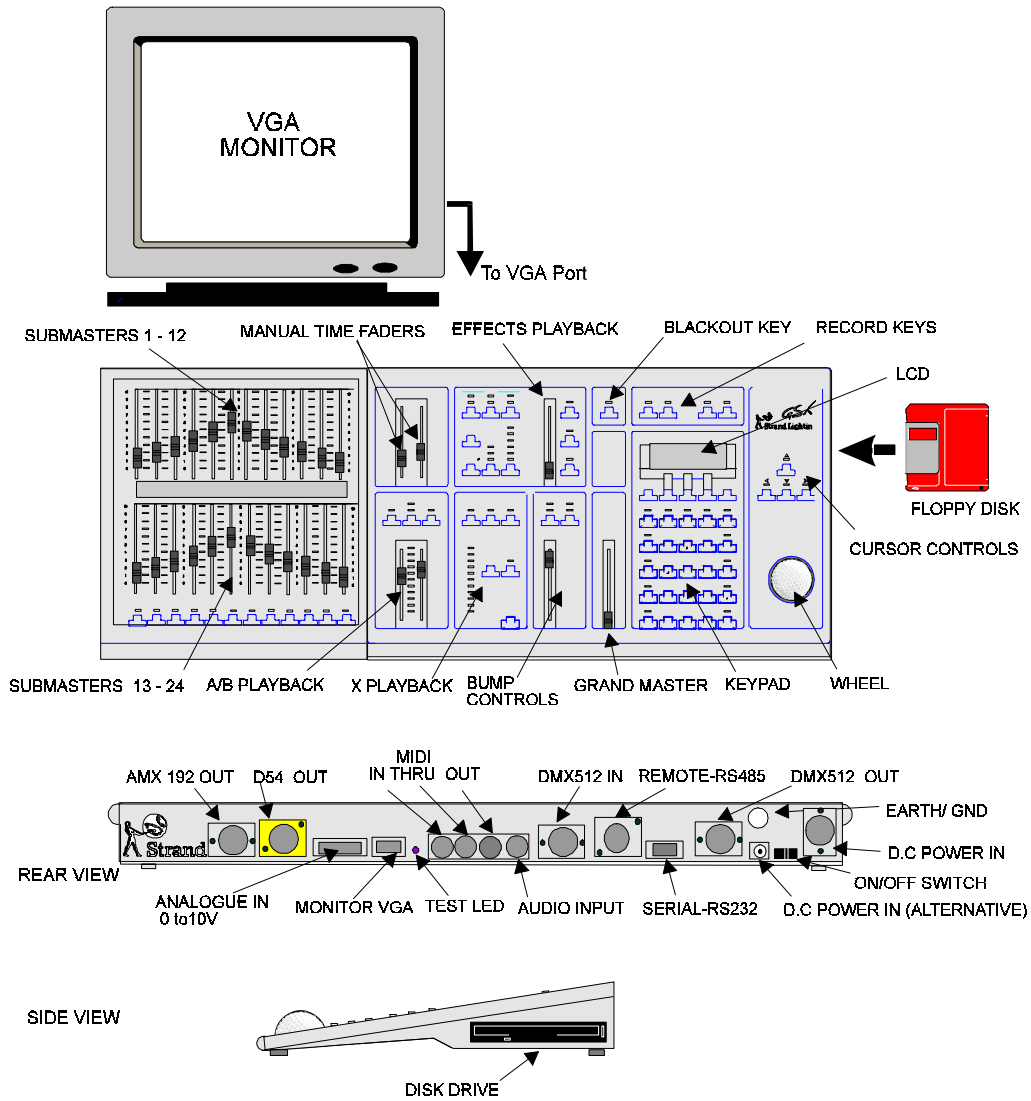

Connecting the Power supply

GSX operates from a low voltage power supply unit (enclosed) and connects to the POWER INPUT socket as shown below. Pin out configuration is shown in **Appendix B**.

There is also a secondary D.C input socket which is made to accept a standard 24VDC power supply.



The secondary socket is provided in case the Strand power supply is mislaid, DO NOT CONNECT MORE THAN ONE SUPPLY TO THE CONSOLE.

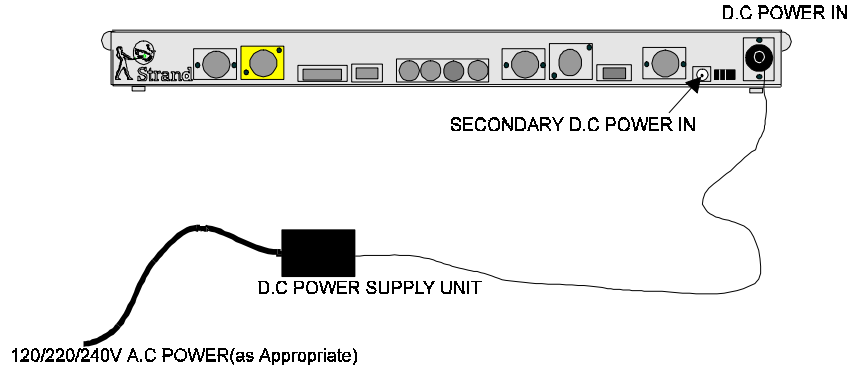

Connecting the Monitor

A standard VGA colour monitor is required to be connected to the VGA socket as shown.

Pin out configurations are shown in **Appendix B**.

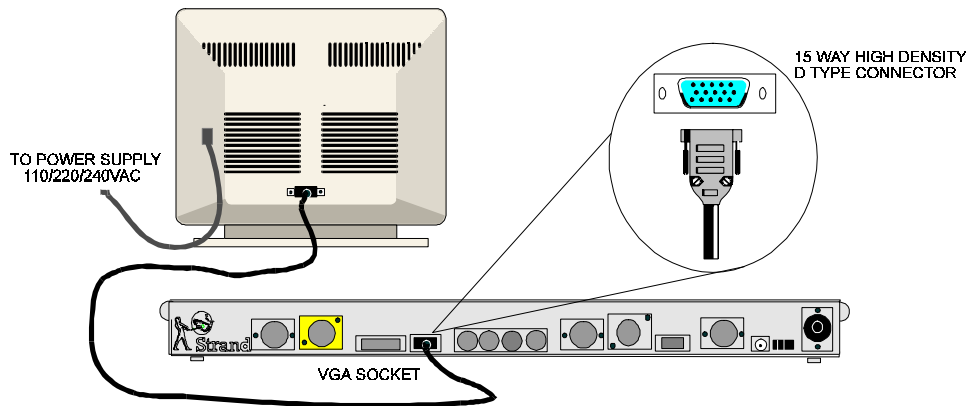

Connecting a Printer

The following list of printer types can be used with GSX via connection to the RS232 port on the rear of the console.

- Plain ASCII (not manufacturer specific)
- Epson FX80
- IBM Proprinter
- HP Laserjet

Or any printer which emulates one of these printers.

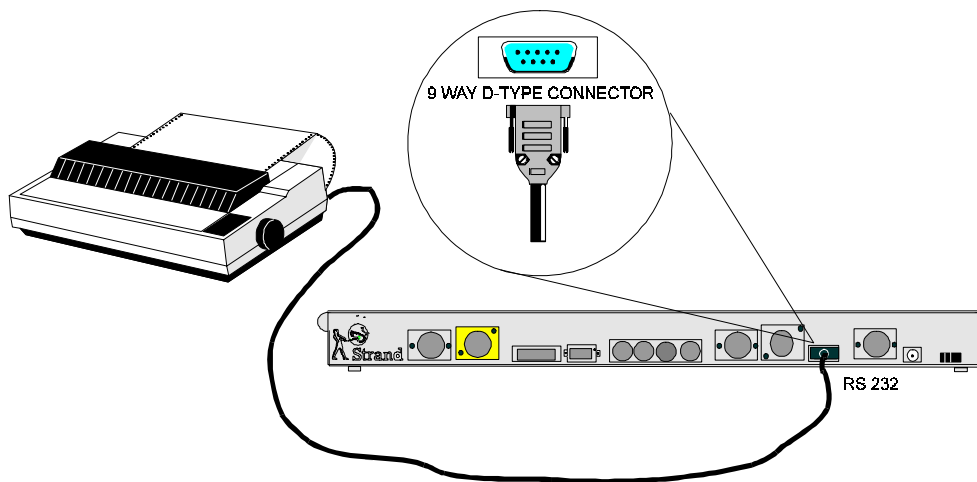

Pin out connections are shown in **Appendix B**.

Connecting the Dimmers

A variety of dimmer racks can be controlled from GSX. In order to cater for these, the following multiplex protocols are available on the consoles back panel.

- AMX192
- D54
- DMX512 OUT
- SMX (for Europe only)

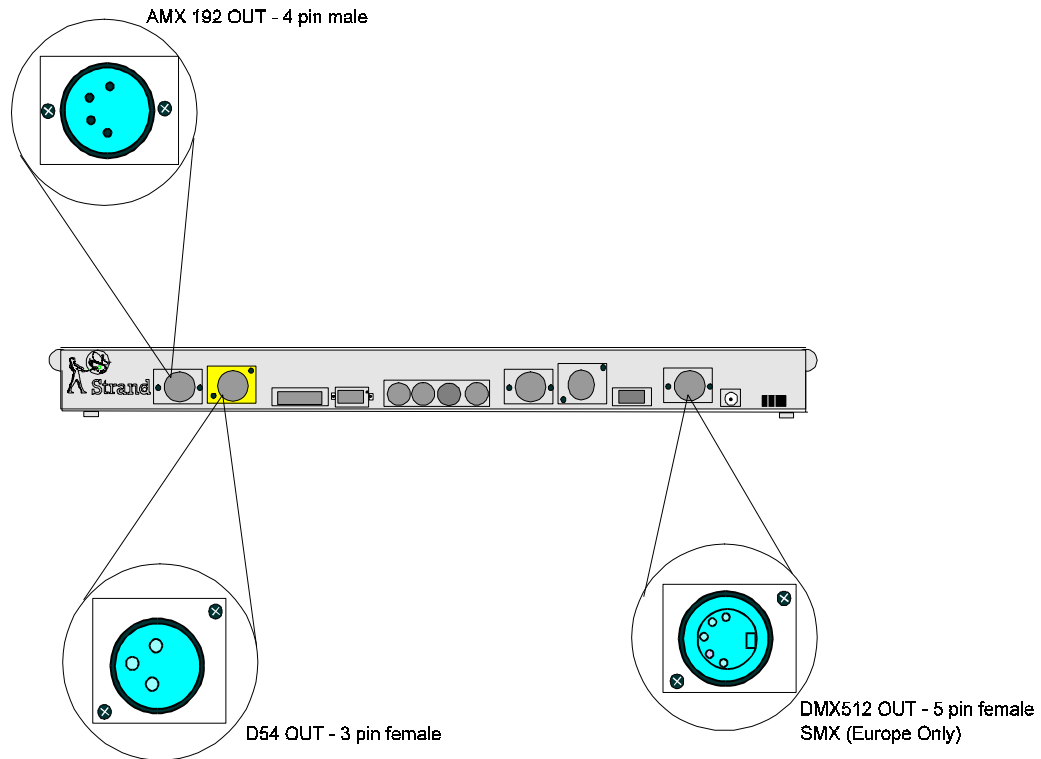

The default protocol is DMX512. When dimmers are connected they will have a default PATCH configuration of 1:1, this means that dimmer no. 1 will be controlled by channel no.1, dimmer no. 100 by channel 100 etc.

This can be changed in the SET-UP screen which is covered later in this chapter.

The pin connections for these outlets are shown in **Appendix B**.

Notes

Software Installation

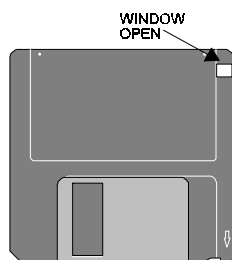

You may bypass this Chapter if your dealer has already installed your selected system configuration

Disks are of the 3.5" type and can be Double Density or High Density. They should be stored and handled with care and kept away from all liquids, heat and magnetic fields. Observe the handling instructions given on the disk packaging.

Any Backup disks will require formatting before use.

The disk aperture is located at the right hand side of the console.

Two types of disk are supplied with Genius.

Operating Software

The Operating software comes pre-installed from manufacture. This system allows future features and operating enhancements to be easily installed as they are developed.

Application Software

The Genius Application programmes are available in 25 channel increments up to a maximum of 125 as listed below:-

- GENIUS 25
- GENIUS 50
- GENIUS 75
- GENIUS 100
- GENIUS 125

Your purchased application will have been despatched with the system and will require loading before the system becomes operational.

You may also wish to upgrade to a bigger channel capacity at a later stage and this can be achieved by installing the appropriate upgrade disk.

Switching on

When all connections are made, the console can be switched on by the ON/OFF rocker switch on the rear of the unit.

Cold Start

If the console is switched on with the ON/OFF switch all output levels will be zero.

Warm Start

If the power supply lead is removed or the power supply interrupted, an abnormal shutdown mode is detected. When power is re-instated, the previous output state will be restored.

On the back of the console the green TEST LED will be flashing, this is normal and indicates that the internal processor is functioning correctly.

Genius memories will be preserved for at least 1 month with GSX/LBX switched off, providing the internal battery is fully charged. To ensure this, it is recommended that consoles are left switched on for 48 hours after unpacking.

When first switched on the LCD menu will be as shown below displaying an Operating Software version which should be compared with the one you are supplied with on the OPERATING SOFTWARE disk.

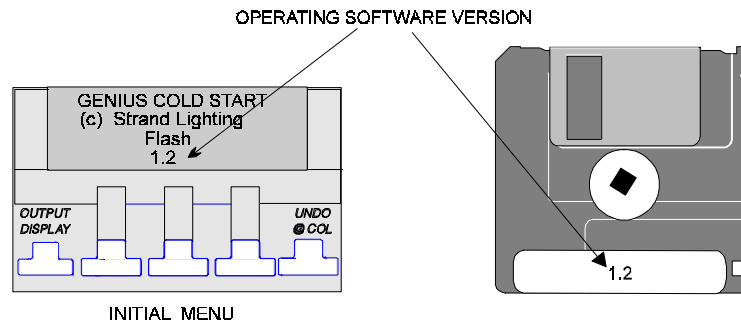

*If the o/s version on your supplied disk is greater then you must update your Operating System before going any further by following the **Loading Operating Software** procedure overleaf.*

Loading Operating Software

Insert your Operating System disk into the disk aperture at the side of the console (label face up) and follow the procedure below.

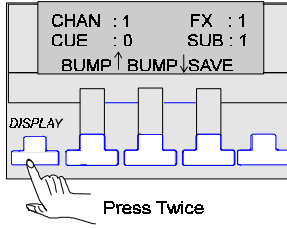

Press the DISPLAY key twice to gain access to the UTILITIES menu



Press ARCHIVE



Press DISK



Press SOFT



Press OPER



Press LOAD,

An ARE YOU SURE ? message appears which you must confirm by pressing LOAD again or cancel by pressing ABORT. The console will now re-initialise and the OUTPUT screen appear after a short period.



An unsuccessful operation will result in an error message, see **Errors/Faultfinding** chapter.

The OUTPUT screen displays the following important information:-

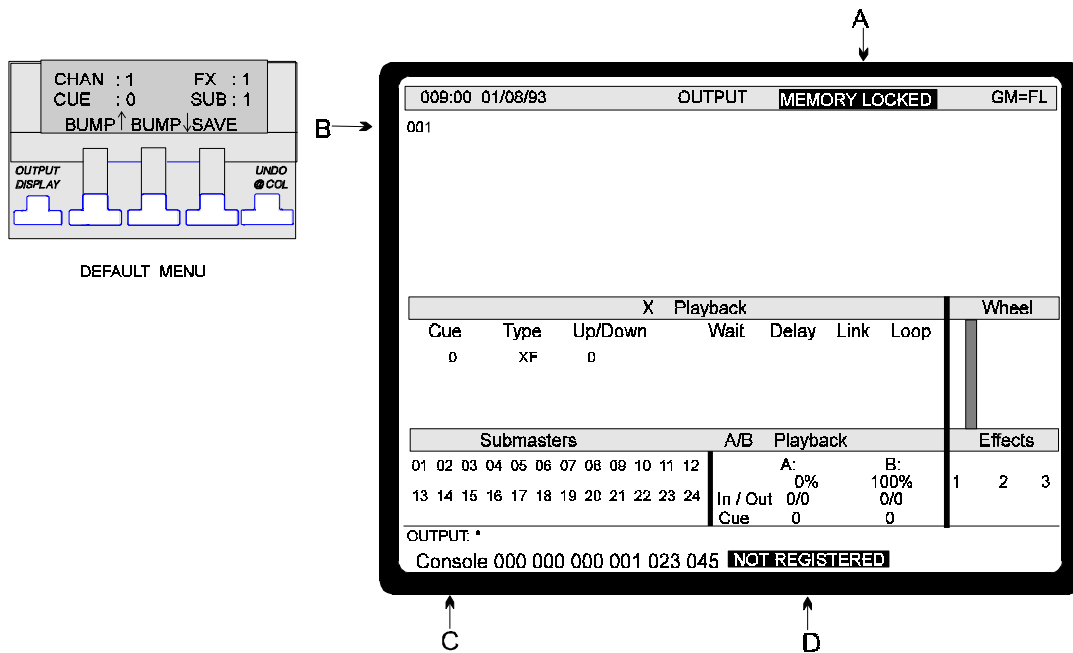

- A. **Memory Locked**- This prevents any loading or saving until the APPLICATION disk is loaded.
- B. **001** - Only 1 channel is available until the APPLICATION disk is loaded.
- C. **Console** -Your console security number that must be sent to Strand's Software Registration Centre to obtain a Password.
- D. **Not Registered** - Reminder of your consoles status.

You now need to load your APPLICATION disk as shown overleaf.

Loading Application Software

Insert your GENIUS APPLICATION disk into the disk aperture at the side of the console (label face up) and follow the procedure below:-

Repeat the procedure to load any other APPLICATION disks.

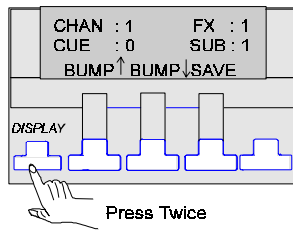

Press the DISPLAY key twice to gain access to the UTILITIES menu



Press ARCHIVE



Press DISK



Press SOFT



Press APPL



Press LOAD

If successful your selected application will now load and on completion, the console re-initialises and the screen changes to indicate the appropriate channel capacity (GENIUS 125 in this case) for a period of 30 seconds before returning to the default setting.



An unsuccessful operation will result in an error message, see **Errors/Faultfinding** chapter.

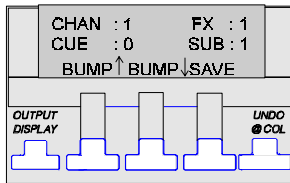

DEFAULT MENU

21 DAY(S) LEFT										OUTPUT										200 Free cues										GM = FL									
001	02	03	04	05	06	07	08	09	10	11	12	13	14	15	16	17	18	19	20	21	22	23	24	025															
026	27	28	29	30	31	32	33	34	35	36	37	38	39	40	41	42	43	44	45	46	47	48	49	050															
051	52	53	54	55	56	57	58	59	60	61	62	63	64	65	66	67	68	69	70	71	72	73	74	075															
076	77	78	79	80	81	82	83	84	85	86	87	88	89	90	91	92	93	94	95	96	97	98	99	100															
101	02	03	04	05	06	07	08	09	10	11	12	13	14	15	16	17	18	19	20	21	22	23	24	125															
X Playback										Wheel																													
Cue	Type	Up/Down	Wait	Delay	Link	Loop																																	
0	XF	0																																					
Submasters										A/B Playback										Effects																			
01	02	03	04	05	06	07	08	09	10	11	12	A: 0%										B: 100%																	
13	14	15	16	17	18	19	20	21	22	23	24	In / Out 0/0										0/0																	
Cue										0										0																			
OUTPUT: *																																							
Console 000 000 000 001 023 045 NOT REGISTERED																																							

Your system is now fully operational and will remain so for a period of 21 days during which you must register your system. A 21 day counter appears in the top left hand corner of the screen

Registration and Passwords

Please complete and fax your registration card to the **Software Registration Centre** at Strand Lighting U.K., who will verify it and issue your exclusive password.

Registration

Part of the Registration form is shown below. If Fax facilities are not available, then please send your Registration form (by Express Post) to your Strand dealer.

FAX

Strand Software Registration Centre, United Kingdom +44 (0) 592 653499
or in case of difficulty contact your nearest Strand lighting office.

PLEASE COMPLETE THE FOLLOWING USING BLOCK LETTERS AND BLACK INK

Date of installation: - -
(DAY) (MONTH) (YEAR)

GSX or LBX → Console: → Model: _____

Shown on bottom of VDU → Security number: - - - - -

Serial number on back of Application disk → Genius: - Genius +25 ch: -

Kaleidoscope: - Communique: -

Shown on back of Operating Software disk → Operating s/w version _____ Rental Software Pack: Yes

Entering Your Password

The password is numerical and will be sent to you in a format similar to the one shown below:-

Strand Lighting Password Certificate	
Serial	: 000 000 000 001 023 045
Channels	: 125
Config	: Genius
Password	: 009 003 022 035 024 006 000 065 003 080 054 012
Date	: Mon Feb 01 19:45:00 1994

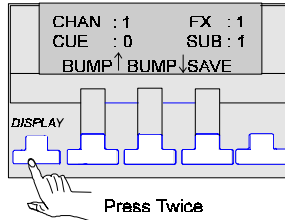

Press the DISPLAY key twice to gain access to the UTILITIES menu

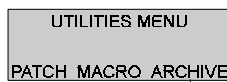

Press ARCHIVE



Press DISK



Press SOFT



Press PASSW

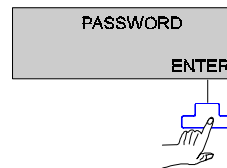

Carefully type in the Password on the keypad.

When complete, press ENTER.

An incorrectly entered password will display an error message. If this happens, press CONT and you will be able to Re-type the number correctly.

Software Installation

Once accepted, the reminder and registration messages on the VDU will disappear signifying that your system is now fully operational permanently.

What Happens if I Don't Register?

After the 21 day period, Recording Cues and Saving Your Show to disk become inhibited, and a **MEMORY LOCKED** message will appear again on the top row of the screen.

If this occurs it is still possible for you to register the system and become fully operational once again.

Upgrades

- a.) Upgrades purchased before entering a password and within the 21 day period can be loaded by following the procedure on page 13.
- b.) Upgrades purchased after you have entered a password will require additional registration and a new password to be issued before use.

Displays and Menus

All console functions are controlled through various VDU screens which in turn are accessed by using the white keys situated below the LCD.

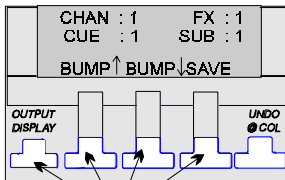

These keys access further menus

Navigating your way through these displays is covered in the **Quickstart Tutorial** chapter and a flow chart of the complete display function is in **Appendix A**.

*If you have a P.C. available, at this stage we recommend you 'Backup' your APPLICATION and OPERATING software by first of all formatting some disks (see 'Formatting Disks' in the in the **Archive** chapter). You can then use the DISKCOPY command on your P.C to back the software up.*

Output Screen

The OUTPUT screen is split into various areas as shown in the diagram below and gives an overall picture of what is going on at all times.

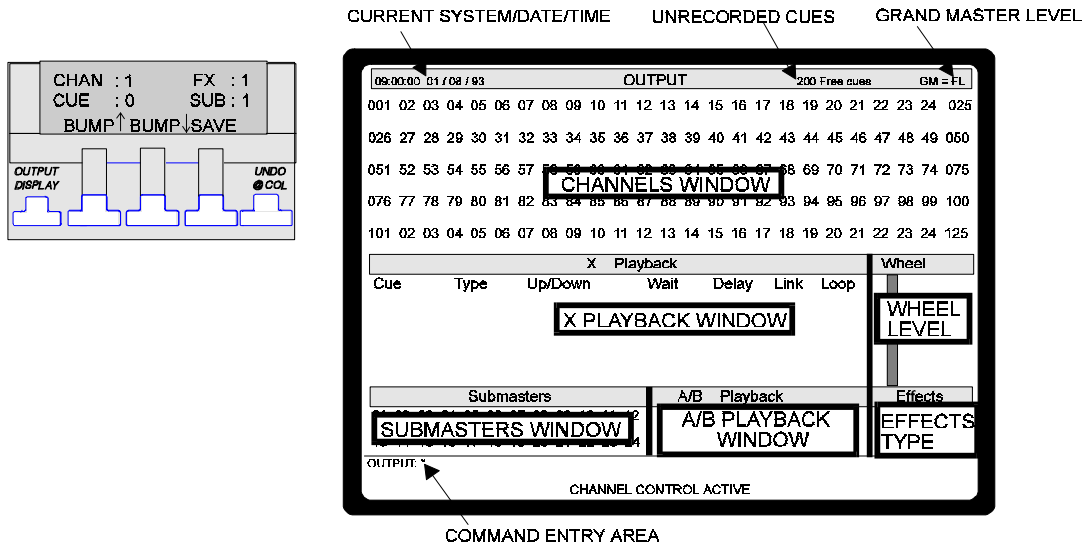

The CHANNELS window shows which channels are currently in use and their respective levels. Level changes are highlighted in various colours and this is covered in the **Channel Control** chapter under "Channel Activity".

The X PLAYBACK window shows a list of all the cues currently fading on the Automatic X Playback and whether they are Cross or Move fades.

The A/B PLAYBACK window shows which cues are currently loaded into the manual A/B Playback.

The SUBMASTERS window shows which Submasters are active and of what type they are.

The EFFECTS TYPE window shows if any effects are currently running.

The WHEEL LEVEL gives a visual representation of the current wheel level or position.

The COMMAND ENTRY area is where all entries are displayed once they are entered on the keypad.

The OUTPUT screen is often referred to throughout this manual and as such also appears in **Appendix A** for quick reference.

Set-up Screen

This screen will show GSX/LBX's default settings and can be changed to suit your own requirements. Initially there is no need to alter anything in order to get the console working unless your dimmers do not receive DMX512, in which case you will have to alter the Dimmer Output setting in the 'Dimmer and Patch' section.

In order to access the screen, press the DISPLAY key three times and then press the key below SET-UP.

The password is numerical and will be sent to you in a format similar to the one shown below:-

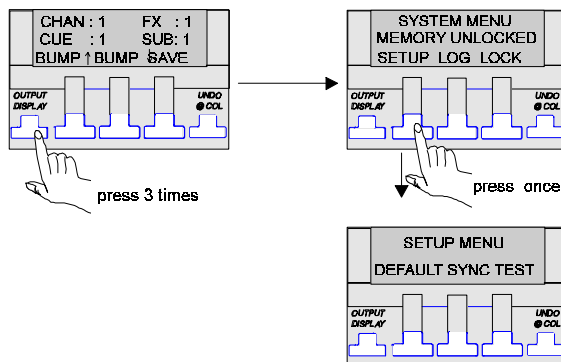

09:00:00 01 / 08 / 93		SETUP		200 Free cues		GM = FL	
Console							
Buzzer	OFF	ON Level %	100	Channel Control Mode	DIRECT 1 DIGIT		
LCD Contrast %	100	Effect Trigger	AUDIO, BASS, BEAT				
LCD Backlight %	50	External Subs. Scale %	100	C / D Mode	← 72 x 1 SCENE-PRESET		
Power Up Macro	OFF						
Wheel Mastering	PROPORTIONAL						
Times							
Fade In / Up	5	X Back	0	Time Display	24HR		
Fade Out / Down	5	X Cut	0	Date Display	DD/MM/YY		
Delay Up	0	Trig Time HHMM		Set Time HHMM			
Delay Down	0	Trig Date DDMM		Set Date DDMM			
Wait	OFF	Trig Macro	OFF	Set Year YYYY			
FX Step	0.5						
Dimmer and Patch		Serial		RS-232		Wheel	
Dimmer Output	DMX512	Baud Rate	9600	Function	PRINTER		
AMX Scaling %	100	Data Bits	8	Printer	ASCII OUT		
D54 Scaling %	100	Parity	NONE	Paper size	A4		
Default Scale %	100	Stop Bits	1	Trig. Byte (s)	OFF OFF OFF		
Default Frame	10	Trig. Macro	OFF				
Default N-Dim	80						
Audio Input		MIDI					
Trig. Macro	OFF	Mode	OFF	Trig. Bytes	OFF	OFF	OFF
		Channel	1	Trig. Macro	OFF	OFF	OFF
		MSC ID	OFF				
APPL GEN 125 KAL COM F1 +0a							
CON5 000 000 000 000 000 000 000							
PASSW 000 000 000 000 000 000 000							
SETUP: *							
Select item to edit							

C/D Mode used for LBX models Only

Menu Editing

When first switched on the highlight box will be in the top left hand corner of the screen on the BUZZER setting.

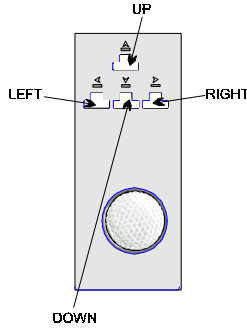

A list of all the various setting options are shown in **Appendix A**.

To get to the required setting, use the four directional cursor keys, situated above the wheel, to move the highlight box around.

To change the setting, move the wheel or alternatively if a setting has numeric values key in the new value.

There are two other options accessible when in the SYSTEM menu and three more in the SET-UP menu.

System Options

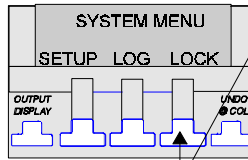

WHEN ACTIVE PREVENTS ANY SHOW, SETUP OR PATCH DATA BEING LOADED FROM DISK. **MEMORY LOCKED** IS DISPLAYED IN THE TITLE BAR

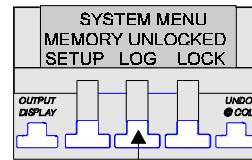

DISPLAYS AN ERROR LIST SEE ERRORS / FAULTFINDING CHAPTER

Set-up Options

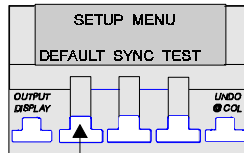

RETURNS HIGHLIGHTED SETTING BACK TO ITS DEFAULT

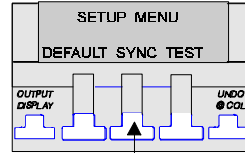

NOT USED - A COMMUNIQUE FUNCTION

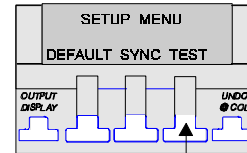

SERVICE FUNCTION - CALLS UP SELF TEST MENUS

To return to a previous menu, press the DISPLAY key

Notes

Quickstart Tutorial

This section will give you sufficient information in order to get up and running very quickly and get the feel of how Genius and GSX operates. It will also build up skill levels and confidence when using the more advanced features that the software offers.

Before undertaking this tutorial, you need to read Chapters 1 and 2 and make sure all necessary connections are made to the dimmer units and subsequent luminaires which in turn are rigged and focused ready for use.

The only settings that may require modification are the Mux output to suit your dimmers.

The tutorial explains how to:-

- Use the keypad.
- Find your way around screens and menus.
- Light your first show using cues.
- Use Submasters.
- Set up a Basic effect

The Keypad & LCD

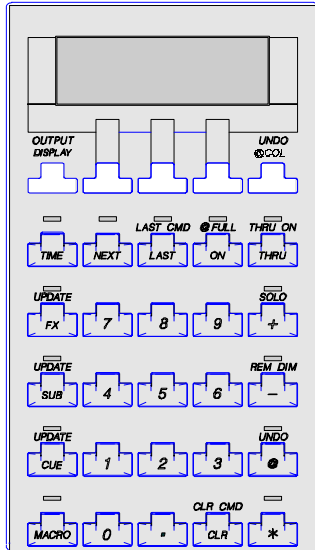

All entries are made on the keypad using functions summarised below.

DISPLAY Selects display on the VGA monitor and LCD.

F1, F2, F3 Unmarked keys on top row, used to select sub-menus and other special functions associated with them.

@COL This key for use with KALEIDOSCOPE.

TIME Identifies next numeric entry as a fade, wait or delay time.

FX Identifies next numeric entry as an effect.

SUB Identifies next numeric entry as a Submaster.

CUE Identifies next numeric entry as a Cue.

MACRO Many keys on the keypad have a secondary function: pressing MACRO first will mean the next keypad entry will execute a pre-programmed sequence of set commands. Preset Macros are shown in Blue on the Keypad.

. Decimal Point - allows accurate time input, e.g. 3.2 seconds or extra cues to be inserted, e.g. Cue 3.2.

NEXT/LAST Increments / decrements last selected Channel, Cue, Sub or FX.

ON Sets all selected channels to a pre-determined level.

THRU Selects a continuous range of numbers, e.g. 1 THRU 5 is the same as entering 1+2+3+4+5.

+ / - Combines or removes Channels, Cues, Submasters for selection.

@ Identifies the next numeric entry to be the intensity of the selected channel(s).

***** The ENTER key (used with COMMAND LINE and PATCH) to execute commands.

CLR Clears last key entered.

Navigating the Displays

The DISPLAY key selects and cycles through four main LCD menus, which all display the OUTPUT screen on the VDU. Each menu contains sub-menus which, in the main, give access to other VDU displays by means of three function keys, F1, F2, F3.

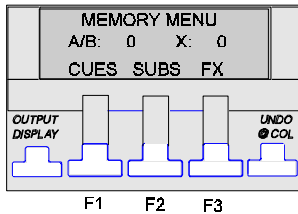
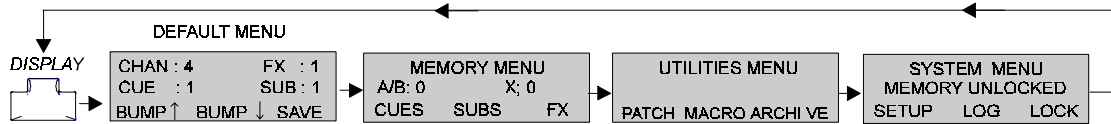

For example, the keys in the MEMORY MENU will activate screens for CUES, SUBMASTERS and EFFECTS (FX) .

A comprehensive flow chart that shows the complete path to all the LCD menus and VDU screens is in the **Appendix** section of this manual.

Pressing the MACRO DISPLAY keys always returns you to the default menu.

The Wheel and Cursor keys

The wheel is used to set levels or set values. Its current setting is displayed continually on screen by a bar graph. The cursor keys above it are used to move around and change values within screens.

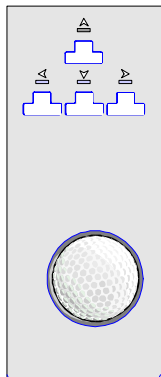

For the purposes of this tutorial, only certain menus and screens will be required and the routes to accessing these are shown overleaf.

Before undertaking to 'Light Your First Show' take time to familiarise yourself with these menus and screen accessing routes.

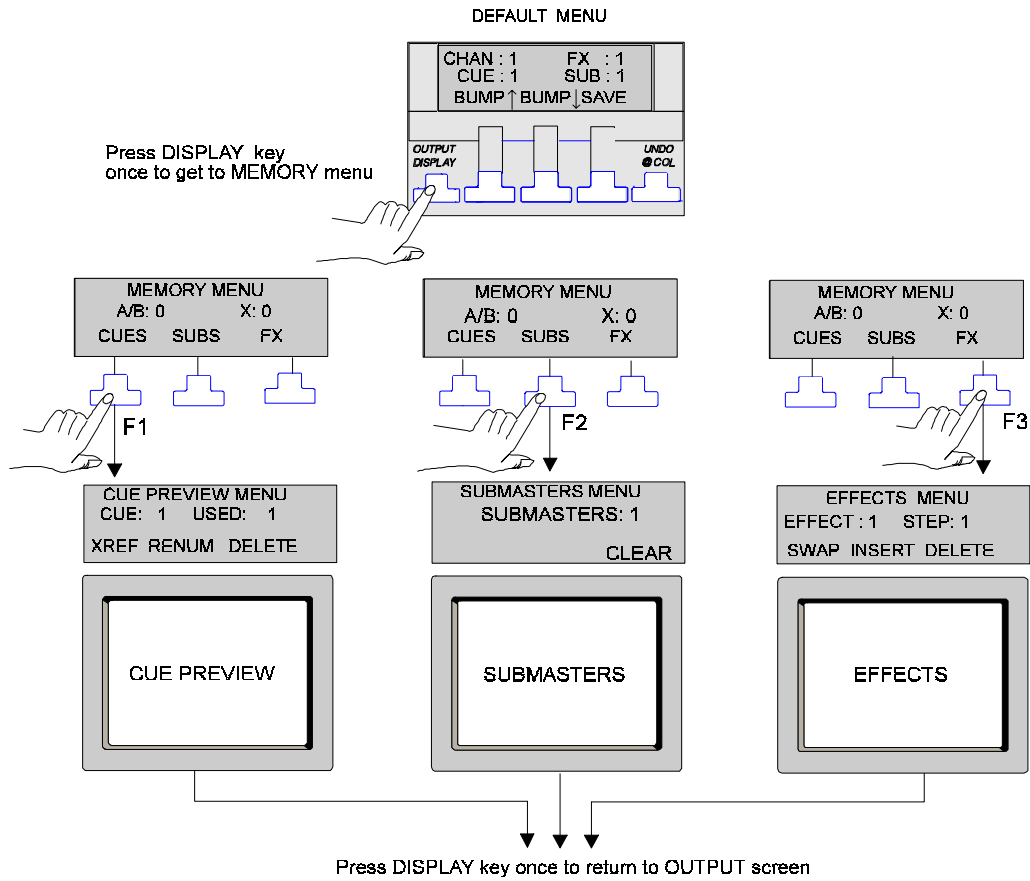

Lighting your first show

Cues

A show plotted using Genius consists of a set of recorded cues.

A cue, often referred to as a memory, determines the following:-

- Which luminaires are on and at what intensity levels.
- The fade time taken to reach those levels.
- Which luminaires are off or dimmed.
- The fade time taken to reach those levels.

The transition between cues is either a Crossfade (XF) or a Movefade (MF), both of these are comprehensively covered in the **Recording Cues** chapter and we shall just be using Crossfades in this section.

Genius' Channel Control setting on the Setup screen defaults to DIRECT 1 DIGIT.

*These modes of operation are covered in detail in the **Channel Control** section and for the purposes of this Tutorial just observe the following rules:-*

- *DIRECT ACTION mode users: enter the commands shown in **BOLD**. The < > symbols require that you follow the action within the brackets.*
- *COMMAND LINE mode users: if this is different, the commands are shown in ITALICS. The ENTER command * is always required here and is bracketed < * > throughout the manual as a reminder.*

Entering & Controlling a Channel

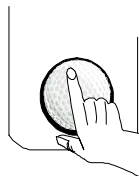
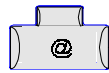

Each lighting channel has a unique number which is entered using the keypad; if a number is entered first GSX always recognises it as a channel entry. The channel has to be assigned a level and this is achieved by using one of two methods:-

1). The @ key on the keypad

1 @ 5 : channel 1 is set instantly to a level of 50%
1 @ 5 <>*.

2). The wheel.

1 <wheel> : move the wheel away from you, the OUTPUT display screen highlights the channel in red and the level fades up smoothly with wheel movement.

The slider faders are Submasters and do not control individual channel levels as in some other lighting control desks.

Setting up a Cue

This example procedure sets up a lighting state ready for recording as CUE 1.



1 THRU 5 <wheel to 75>

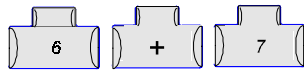

6 + 7 @ 9
6 + 7 @ 9 < * >

Entries appear in the command entry line section of the OUTPUT display. Levels of channels 6 and 7 can now be changed by using the wheel if desired.

09:00:00 01 / 08 / 83		OUTPUT																		200 Free cues				GM = FL						
001	02	03	04	05	06	07	08	09	10	11	12	13	14	15	16	17	18	19	20	21	22	23	24	025						
75	75	75	75	75	90	90																								
026	27	28	29	30	31	32	33	34	35	36	37	38	39	40	41	42	43	44	45	46	47	48	49	050						
051	52	53	54	55	56	57	58	59	60	61	62	63	64	65	66	67	68	69	70	71	72	73	74	075						
076	77	78	79	80	81	82	83	84	85	86	87	88	89	90	91	92	93	94	95	96	97	98	99	100						
101	02	03	04	05	06	07	08	09	10	11	12	13	14	15	16	17	18	19	20	21	22	23	24	125						
OUTPUT: 6 + 7 @ 9 *																														
CHANNEL CONTROL ACTIVE																														

Channels 1 to 5 now have the levels displayed at 75.

Channels 6 and 7 now have levels highlighted in red as these are currently selected.

Recording Cues For The show

To record this scene as CUE 1, key in the following command:-

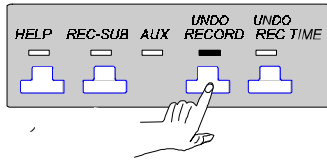

CUE 1 RECORD
*RECORD 1 < * >*

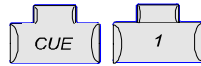

Whilst still in the OUTPUT screen, follow the procedures below to set up and record another four cues to complete the show.

CUE 2 **1 THRU 5 <wheel to 0>** (Not required in this cue).
8 THRU 10 <wheel to FL>

CUE 2 RECORD
*RECORD 2 < * >*

CUE 3 **1 THRU 3 <wheel to 50>**

CUE 3 RECORD
*RECORD 3 < * >*

CUE 4 **1 THRU 7 - 4 <wheel to FL>** (Puts on channels 1 to 7 except
ch. 4).

CUE 4 RECORD
*RECORD 4 < * >*

CUE 5 **1 THRU 10 <wheel to 0>**
4 <wheel to 20>

CUE 5 RECORD
*RECORD 5 < * >*

MEMORY MENU
 A/B: 0 X: 0
 CUES SUBS FX



CUE PREVIEW MENU
 CUE : 1 USED : 5
 XREF RENUM DELETE

CUE PREVIEW

Once all these cues have been recorded they can be viewed by going to the CUE PREVIEW screen.

All the cues are shown in the CUE SHEET window with type of fade (XF) and default fade times of 5/5 seconds (UP/DOWN).

WAIT, DELAY times and the LINK and LOOP features are not used at this stage.

The contents of the cue are shown in the channels window depending on which cue the highlight box is over. The box can be moved about by the cursor keys above the wheel and the channel window display will change accordingly.

Your screen should now correspond to the five figures shown in the next two pages.

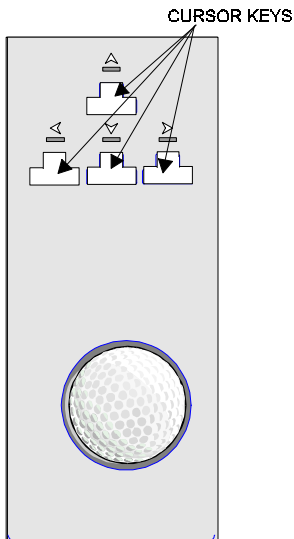

09:00:00 01 / 08 / 93 CUE PREVIEW 195 Free cues GM = FL

001 02 03 04 05 06 07 08 09 10 11 12 13 14 15 16 17 18 19 20 21 22 23 24 025
 75 75 75 75 90 90

026 27 28 29 30 31 32 33 34 35 36 37 38 39 40 41 42 43 44 45 46 47 48 49 050

051 52 53 54 55 56 57 58 59 60 61 62 63 64 65 66 67 68 69 70 71 72 73 74 075

076 77 78 79 80 81 82 83 84 85 86 87 88 89 90 91 92 93 94 95 96 97 98 99 100

101 02 03 04 05 06 07 08 09 10 11 12 13 14 15 16 17 18 19 20 21 22 23 24 125

Cue Sheet							Wheel
Cue	Type	Up/Down	Wait	Delay	Link	Loop	
1	XF	5/5	OFF	0/0	0	0	1
2	XF	5/5	OFF	0/0	0	0	
3	XF	5/5	OFF	0/0	0	0	
4	XF	5/5	OFF	0/0	0	0	
5	XF	5/5	OFF	0/0	0	0	

HIGHLIGHT BOX

09:00:00 01 / 08 / 93 CUE PREVIEW 195 Free cues GM = FL

001 02 03 04 05 06 07 08 09 10 11 12 13 14 15 16 17 18 19 20 21 22 23 24 025
 90 90 FL FL FL

026 27 28 29 30 31 32 33 34 35 36 37 38 39 40 41 42 43 44 45 46 47 48 49 050

051 52 53 54 55 56 57 58 59 60 61 62 63 64 65 66 67 68 69 70 71 72 73 74 075

076 77 78 79 80 81 82 83 84 85 86 87 88 89 90 91 92 93 94 95 96 97 98 99 100

101 02 03 04 05 06 07 08 09 10 11 12 13 14 15 16 17 18 19 20 21 22 23 24 125

Cue Sheet							Wheel
Cue	Type	Up/Down	Wait	Delay	Link	Loop	
1	XF	5/5	OFF	0/0	0	0	2
2	XF	5/5	OFF	0/0	0	0	
3	XF	5/5	OFF	0/0	0	0	
4	XF	5/5	OFF	0/0	0	0	
5	XF	5/5	OFF	0/0	0	0	

09:00:00 01 / 08 / 93		CUE PREVIEW										195 Free cues										GM = FL		
001	02	03	04	05	06	07	08	09	10	11	12	13	14	15	16	17	18	19	20	21	22	23	24	025
50	50	50				90	90	FL	FL	FL														
026	27	28	29	30	31	32	33	34	35	36	37	38	39	40	41	42	43	44	45	46	47	48	49	050
051	52	53	54	55	56	57	58	59	60	61	62	63	64	65	66	67	68	69	70	71	72	73	74	075
076	77	78	79	80	81	82	83	84	85	86	87	88	89	90	91	92	93	94	95	96	97	98	99	100
101	02	03	04	05	06	07	08	09	10	11	12	13	14	15	16	17	18	19	20	21	22	23	24	125

Cue Sheet							Wheel
Cue	Type	Up/Down	Wait	Delay	Link	Loop	
1	XF	5 / 5	OFF	0 / 0	0	0	
2	XF	5 / 5	OFF	0 / 0	0	0	
3	XF	5 / 5	OFF	0 / 0	0	0	
4	XF	5 / 5	OFF	0 / 0	0	0	
5	XF	5 / 5	OFF	0 / 0	0	0	

09:00:00 01 / 08 / 93		CUE PREVIEW										195 Free cues										GM = FL		
001	02	03	04	05	06	07	08	09	10	11	12	13	14	15	16	17	18	19	20	21	22	23	24	025
FL	FL	FL				FL	FL	FL	FL	FL														
026	27	28	29	30	31	32	33	34	35	36	37	38	39	40	41	42	43	44	45	46	47	48	49	050
051	52	53	54	55	56	57	58	59	60	61	62	63	64	65	66	67	68	69	70	71	72	73	74	075
076	77	78	79	80	81	82	83	84	85	86	87	88	89	90	91	92	93	94	95	96	97	98	99	100
101	02	03	04	05	06	07	08	09	10	11	12	13	14	15	16	17	18	19	20	21	22	23	24	125

Cue Sheet							Wheel
Cue	Type	Up/Down	Wait	Delay	Link	Loop	
1	XF	5 / 5	OFF	0 / 0	0	0	
2	XF	5 / 5	OFF	0 / 0	0	0	
3	XF	5 / 5	OFF	0 / 0	0	0	
4	XF	5 / 5	OFF	0 / 0	0	0	
5	XF	5 / 5	OFF	0 / 0	0	0	

09:00:00 01 / 08 / 93		CUE PREVIEW										195 Free cues										GM = FL		
001	02	03	04	05	06	07	08	09	10	11	12	13	14	15	16	17	18	19	20	21	22	23	24	025
			20																					
026	27	28	29	30	31	32	33	34	35	36	37	38	39	40	41	42	43	44	45	46	47	48	49	050
051	52	53	54	55	56	57	58	59	60	61	62	63	64	65	66	67	68	69	70	71	72	73	74	075
076	77	78	79	80	81	82	83	84	85	86	87	88	89	90	91	92	93	94	95	96	97	98	99	100
101	02	03	04	05	06	07	08	09	10	11	12	13	14	15	16	17	18	19	20	21	22	23	24	125

Cue Sheet							Wheel
Cue	Type	Up/Down	Wait	Delay	Link	Loop	
1	XF	5 / 5	OFF	0 / 0	0	0	
2	XF	5 / 5	OFF	0 / 0	0	0	
3	XF	5 / 5	OFF	0 / 0	0	0	
4	XF	5 / 5	OFF	0 / 0	0	0	
5	XF	5 / 5	OFF	0 / 0	0	0	

The WHEEL column indicates the position of the selected cue in the CUE SHEET. Here we have only 5 cues so the marker starts at the top for the first cue and ends at the bottom for cue 5.

Once in this screen the cue can be modified, for example move the box to the Up/Down field and type in 10 for both Up and Down fades.

Channel levels can also be changed as in the following example:-

Move box over CUE 3 and key in:-

4 + 5 @ 7.5

4 + 5 @ 7.5 < * >

These will be automatically recorded and added to the existing cue.

The wheel cannot be used to alter channel levels in the CUE PREVIEW screen. The use of colour in these screens is explained in Appendix A.

Playing Back Cues

There are two Playbacks for playing back cues:-

- **X Playback** - for automatic operation.
- **A/B Playback** - for manual operation.

Only the X Playback will be used here.

Return to the OUTPUT screen (press MACRO DISPLAY).

Key in **CUE 1 LOAD X**

Press **GO**. The first cue in the CUE SHEET will start to fade up.

Press **GO** again. Channels in the first cue start to fade down and those in the second cue start to fade up.

Repeat until all cues have been executed. Fade progress is displayed on the LED bar and Playback displays.

Cues can be loaded and played back out of sequence if required by simply keying in **CUE xx GO** (where xx is the selected cue number).

To clear the lights up on stage and the screen:

1 THRU 10 <Wheel To Zero> CLR

or

CUE 0 GO (Cue 0 is always a blackout)

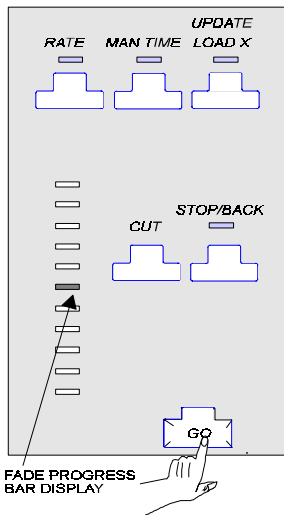

Using Submasters

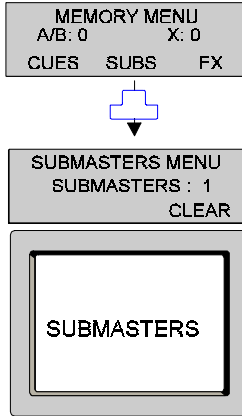

The 24 faders on GSX control 24 Submasters, which are stores for groups of channels with recorded levels. These channel levels are proportionally controlled by their associated fader.

There are many uses for Submasters as you will soon discover, but for now we will assign them to a couple of typical applications, namely house and orchestra lighting.

As an example, orchestra lighting will be channels 20 - 22 and house lights channels 30 - 35.

From the MEMORY MENU press the key shown and go to the SUBMASTERS screen.

In this screen, channel levels must be keyed in using the @ key; however, the wheel is operational in all the other fields.

ORCHESTRA LIGHTING

Make sure highlight box is on SUB 1 and key in the following:-

20 THRU 22 @ 9 *

Submasters						Wheel	
SUB:	In/Out	Function	Macro	Inhibit	SUB:	In/Out	
1	0/0	LOCAL	OFF	NO	13	0/0	
2	0/0	LOCAL	OFF	NO	14	0/0	
3	0/0	LOCAL	OFF	NO	15	0/0	
4	0/0	LOCAL	OFF	NO	16	0/0	
5	0/0	LOCAL	OFF	NO	17	0/0	

SUBMASTER : 20 THRU 22 @ 9 *

HOUSE LIGHTING

Move the highlight box to SUB 2 and key in the following:-

30 THRU 35 @ 9 *

Submasters						Wheel	
SUB:	In/Out	Function	Macro	Inhibitive	SUB:	In/Out	
1	0/0	LOCAL	OFF	NO	13	0/0	
2	0/0	LOCAL	OFF	NO	14	0/0	
3	0/0	LOCAL	OFF	NO	15	0/0	
4	0/0	LOCAL	OFF	NO	16	0/0	
5	0/0	LOCAL	OFF	NO	17	0/0	

SUBMASTER : 30 THRU 35 @ 9 *

When data is entered in this screen it is automatically recorded into the highlighted Submaster.

The Submaster screen incorporates some sophisticated editing features but at this stage we will only look at one of these fields - IN/OUT (fade times).

The house lights should be set to fade in and fade out at a particular rate.

Move the highlight box to the IN field in Submaster 2

Type in or wheel to 20

Move the highlight box to the OUT field

Type in or wheel to 10

Submasters					Wheel	
SUB:	In/Out	Function	Macro	Inhibitive	SUB:	In/Out
1	0/0	LOCAL	OFF	NO	13	0/0
2	20/10	LOCAL	OFF	NO	14	0/0
3	0/0	LOCAL	OFF	NO	15	0/0
4	0/0	LOCAL	OFF	NO	16	0/0
5	0/0	LOCAL	OFF	NO	17	0/0
6	0/0	LOCAL	OFF	NO	18	0/0
7	0/0	LOCAL	OFF	NO	19	0/0
8	0/0	LOCAL	OFF	NO	20	0/0
9	0/0	LOCAL	OFF	NO	21	0/0
10	0/0	LOCAL	OFF	NO	22	0/0
11	0/0	LOCAL	OFF	NO	23	0/0
12	0/0	LOCAL	OFF	NO	24	0/0

Effects		
1	2	3

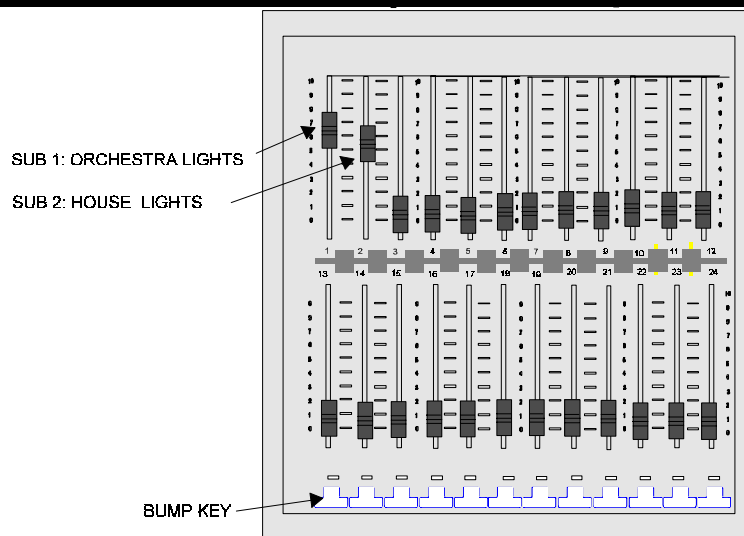

Both Submasters are now controlled by their respective faders, however, action of Submaster 2 is delayed so that houselights fade up over 20 seconds. Return to the OUTPUT screen and try them out.

The Contents of Submaster 1 and 2 can be 'flushed up' by pressing the white bump keys below the appropriate faders. These bump keys control Subs. 13 -24 (bottom row). the same Bump keys used with the MACRO key control Subs 1 - 12.(top row).

These features are detailed in the **Submasters** chapter.

Setting up a Basic Effect

Effects are built up in steps, each step remaining on for a specified time before changing to the next one. Genius will allow up to 3 chase effects to be set up.

Example: Set up channels 1 to 8 with a CHASE effect.

Go to the EFFECTS PREVIEW screen.

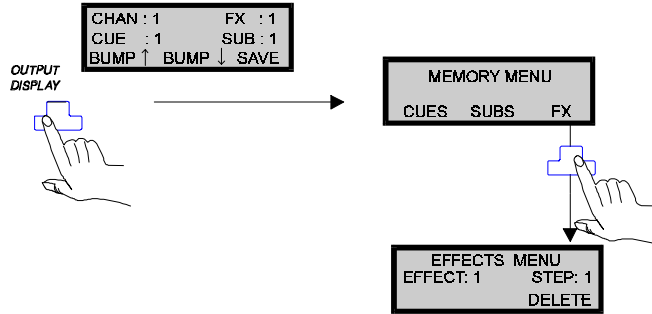

09:00:00 01 / 08 / 93 EFFECTS PREVIEW 200 Free cues GM = FL

001 02 03 04 05 06 07 08 09 10 11 12 13 14 15 16 17 18 19 20 21 22 23 24 025

026 27 28 29 30 31 32 33 34 35 36 37 38 39 40 41 42 43 44 45 46 47 48 49 050

051 52 53 54 55 56 57 58 59 60 61 62 63 64 65 66 67 68 69 70 71 72 73 74 075

076 77 78 79 80 81 82 83 84 85 86 87 88 89 90 91 92 93 94 95 96 97 98 99 100

101 02 03 04 05 06 07 08 09 10 11 12 13 14 15 16 17 18 19 20 21 22 23 24 125

Effects Sheet					Wheel
FX Step	Type	Dir	Fade T	Step T	
1	CHASE	FWD	5/5	0.1	

Submasters												A/B	Playback	Effects		
01	02	03	04	05	06	07	08	09	10	11	12	A	B	1	2	3
13	14	15	16	17	18	19	20	21	22	23	24	In / Out				
Cue																

EFFECT PREVIEW :*

Select an effect memory, then edit an item or set steps

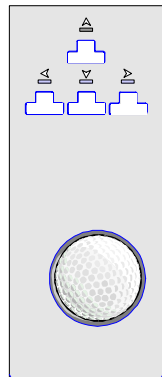

1. Make sure the highlight box is in the Effects Sheet on Step 1.1. If the highlight box is not in this position move it with the cursor keys. The first step is always pre-recorded and only needs a channel to be entered.
2. Key in **1 ON *** This assigns channel 1 to step 1 of the first effect.

Channels are always at Full, levels cannot be entered.

3. Key in the following:-

FX . 2 RECORD *

*RECORD FX . 2 < * >* Records Step 2, there is no need to key in FX 1.2.

1 @ 0* Clears previous entry

2 ON* This assigns channel 2 to Step 2.

4. **FX . 3 RECORD***

*RECORD FX . 3 < * >* Records Step 3.

2 @ 0 * Clears previous entry

3 ON * This assigns channel 3 to Step 3.

*When you press RECORD it in fact copies the previous cue and this is why you need to get rid of the last channel entered for this chase sequence. Quicker methods of doing this are discussed in the **Basic Effects** chapter.*

The Effects Sheet should look like the figure below.

Effects Sheet					Wheel
FX Step	Type	Dir	Fade T	Step T	
1.1	CHASE	FWD	5/5	0.1	
1.2	CHASE	FWD	5/5	0.1	
1.3	CHASE	FWD	5/5	0.1	
Submasters			A/B	Playback	Effects

5. Repeat 3 and 4 to assign channels 4 to 8 to **FX 1 Steps** 4 to 8.

Your Effects Sheet should now look like the figure below.

Effects Sheet					Wheel
FX Step	Type	Dir	Fade T	Step T	
1.1	CHASE	FWD	5/5	0.5	
1.2	CHASE	FWD	5/5	0.5	
1.3	CHASE	FWD	5/5	0.5	
1.4	CHASE	FWD	5/5	0.5	
1.5	CHASE	FWD	5/5	0.5	
1.6	CHASE	FWD	5/5	0.5	
1.7	CHASE	FWD	5/5	0.5	
1.8	CHASE	FWD	5/5	0.5	
Submasters			A/B	Playback	Effects

6. Leave all other fields at their default settings for the moment.

Running the Effect

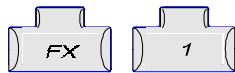

To run the effect, it must be loaded into one of the three Effects Playbacks. We shall only be loading one in this section.

1. Press **FX** and **1** on the keypad to select effect number 1.
2. Press key **1** on the Playback to load the effect. The LOADED and SELECTED LEDs will light along with the FWD and CHASE LEDs.
3. Press **GO** to run the effect. The whole effect will fade in over a 5 second period and steps will be at 0.5 second intervals.

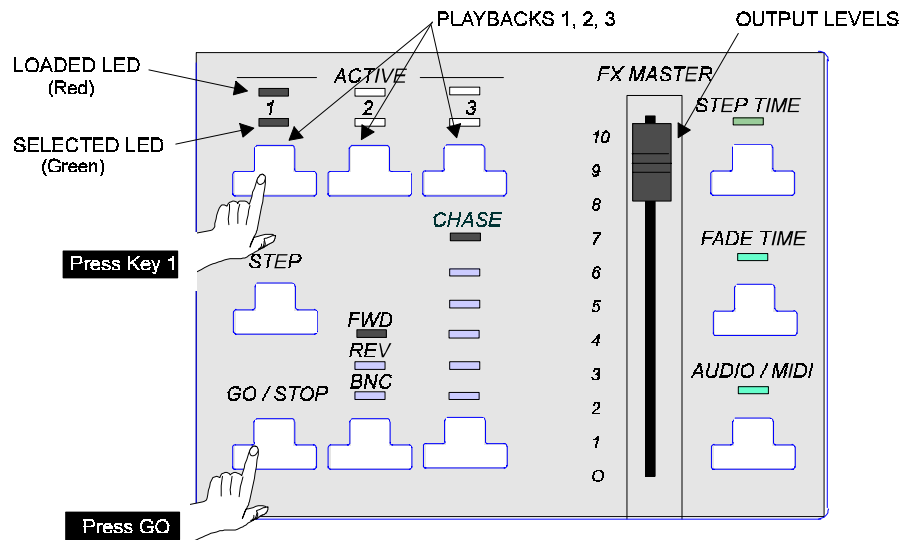

4. Press **GO** again to stop the effect. The whole effect will fade out over a 5 second period.

The FX MASTER fader controls channel output levels for all running effects.

Now try moving the highlight box around and changing settings for the Dir, Fade T and Step T fields. You will notice that a changed setting, in FX 1 for example, will apply to all steps in that effect once the box is moved away from it but FX 2 and 3 remain the same.

Saving a Show to Disk

To save a show you need to format a disk and insert it into the disk drive at the right hand side of the console.

This is covered in detail in the **Archive Screen** chapter of this manual.

Remarks

- Although this Tutorial has deliberately jumped from screen to screen it is worth noting that in practice most keying in and setting up can be achieved with only the OUTPUT screen active. The other screens are primarily used for previewing and editing.

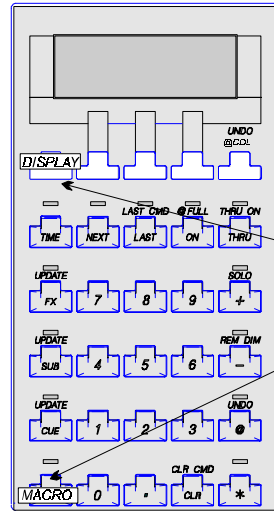

- Remember, to go back to the previous menu or display, press the DISPLAY key
- Press MACRO DISPLAY to return to the default menu.

Channel Control

Channel Control is used to select and control intensity channels and their respective levels.

Command Modes

Genius may be used in either **DIRECT ACTION** or **COMMAND LINE** mode which can be selected in the SET-UP screen

Commands are shown typed in **BOLD UPPERCASE**.

Level Entry Formats

Level entries can be in **DOUBLE DIGIT** (per cent) or **SINGLE DIGIT** (point) format. This is selectable in the SET-UP screen.

These two options are best illustrated in the following examples where channels 1 to 3 are each required to be set at levels of 5%, 55%, and 90%.

DOUBLE DIGIT	1 @ 05 *	5%
	2 @ 55	55%
	3 @ 90 *	90%

SINGLE DIGIT	1 @ 0.5 *	5%
	2 @ 5.5 *	55%
	3 @ 9 *	90%

Direct Action Mode

In this mode the command is carried out after completing a logical action. An asterisk * (which is the ENTER symbol), is automatically added to the entry line on the VDU. Any subsequent entries will clear the entry line and start a new sequence.

Command Line Mode

In this mode no action will take place until the ENTER <*> key is pressed. A combination of SINGLE and DOUBLE DIGIT format is used, where entries keyed in as a single figure will be recognised and assumed to be in multiples of 10.

The examples shown in the rest of the section are common to both command types so if you have COMMAND LINE mode selected remember to press the ENTER key.

Selecting Channels & Setting Levels

Channel levels are set by using the @ key, ON key or @FULL macro to set to a fixed level or alternatively by wheel to continually adjust the level.

1 @ 3 * Sets channel 1 at a level of 30%



1 <wheel> * Continually adjusts channel 1 level

ON

The ON key is programmable to any level between 0 and 100%. The default setting is 100% but may be changed using the SET-UP screen, (see **Appendix** and **Setup** sections).

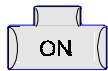

1 ON * Sets channel 1 to the current ON level.

@ FULL (MACRO ON)

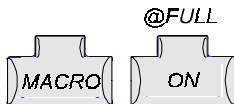

The @FULL key sets levels at full (100% abbreviated as FL).

5 THRU 20 @FULL * (MACRO ON) Sets channels 5 to 20 at 100%.

Pressing the @ key before the FULL or ON key is not necessary but will be accepted.

+ key

1 + 5 + 9 + 11 @ 9 * Channels 1, 5, 9 and 11 at a level of 90%

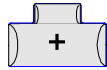

1 + 5 + 9 + 11 <wheel> * Continually adjusts channels 1, 5, 9 and 11.

CHAN : 11	FX : 1
CUE : 1	SUB : 1
BUMP ↑	BUMP ↓ SAVE

The last channel number entered is always displayed in the LCD.

THRU

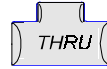

The THRU key is a quick way of entering a range of channels.

1 THRU 5 * is the same as entering **1 + 2 + 3 + 4 + 5 ***

Ranges using the THRU key can be controlled in either direction.

*1 THRU 12 * is the same as 12 THRU 1 **

- key

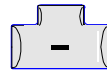

Channels can be removed from a selection by using the - key.

1 THRU 7 - 5 * will remove channel 5 from the selected range and only channels 1, 2, 3, 4, 6, 7 will be selected.

Where MACRO commands are used, the MACRO key is always pressed first.

THRU ON selects channels in the thru range that actually have levels and ignores those that are not on.

THRU ON (MACRO THRU)

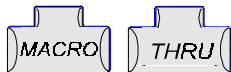

1 THRU ON 5 * (MACRO THRU)

For example, the levels of these channels may be as follows:-

CH 1=50% CH 2=70% CH 3=Off CH 4=30% CH 5=Off

In this case only channels 1, 2 and 4 will be selected.

Combination Entries

Several types of entry can be combined.

1 THRU 5 + 15 THRU 26 @ 5 * This will make channels 1 to 5 and also 15 to 26 go to 50%.

1 THRU 5 + 10 + 25 - 4 @ 5 * This will make channels 1, 2, 3, 5, 10 and 25 all go to 50%. Channel 4 remains at its previous level.

NEXT, LAST

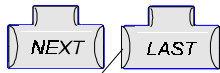

```
CHAN: 4      FX : 1
CUE  : 1      SUB : 1
BUMP ↑ BUMP ↓ SAVE
```

In Channel Control, these keys operate on the last number entered. This can be checked by looking at the figure currently displayed in the LCD. The number can then be incremented or decremented by using these keys, as shown in this sequence of examples:-

NEXT ON * would set channel 5 to ON level.

LAST @ 5 * would set channel 4 to 50%.

LAST LAST @ 5 * would set channel 2 to 50%.

CLR



The clear key (CLR) clears the last key entry made.

1 THRU 10 + 24 CLR will leave the command line as:-

1 THRU 10 + 2

Pressing **CLR** again will leave the line above as:-

1 THRU 10 +

MACRO CLR



This clears the complete command line.

1 THRU 10 + 24 MACRO CLR

This will leave the command line showing * (the ENTER Symbol).

UNDO @ (MACRO @)

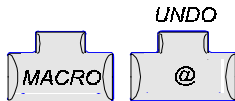

Restores all intensity channels to the levels they were at before the @ key was last used to set levels.

Invalid Key Entries

Invalid key entries are not accepted and result in a warning message being displayed on the VDU. If this happens you can do any of the following to correct the situation:-

- Type a corrected entry.
- Press CLR and edit the key entry.
- Press MACRO CLR and delete the whole command line.

Current Selection

Channels that have been selected using numeric keys, together with +, - or THRU, are called the CURRENT SELECTION. The CURRENT SELECTION is always highlighted with a red background on the OUTPUT display. Once selected these levels can be set or modified as a group by the @, ON and @FULL keys or the wheel.

The figure below shows channels 5 through 10 as the CURRENT SELECTION.

08:00:00 01 / 08 / 93																								OUTPUT				200 Free cues				GM = FL			
001	02	03	04	05	06	07	08	09	10	11	12	13	14	15	16	17	18	19	20	21	22	23	24	025											
80	80	75	30	30	FL	FL	FL	70	50	50	FL	FL	FL	80	75	30	30	80	FL	FL															
026	27	28	29	30	31	32	33	34	35	36	37	38	39	40	41	42	43	44	45	46	47	48	49	050											
051	52	53	54	55	58	57	58	59	60	61	62	63	64	65	66	67	68	69	70	71	72	73	74	075											
076	77	78	79	80	81	82	83	84	85	86	87	88	89	90	91	92	93	94	95	96	97	98	99	100											
101	02	03	04	05	06	07	08	09	10	11	12	13	14	15	16	17	18	19	20	21	22	23	24	125											
X Playback												Wheel																							
Cue	Type	Up/Down	Wait	Delay	Link	Loop																													
Submasters												A/B Playback						Effects																	
01	02	03	04	05	06	07	08	09	10	11	12	A						B																	
13	14	15	16	17	18	19	20	21	22	23	24	In / Out Cue						1 2 3																	
OUTPUT: *																																			
CHANNEL CONTROL ACTIVE																																			

If 5 THRU 10 are adjusted by the wheel, the OUTPUT display screen will show the channel levels changing with wheel movement.

Levels previously set using the @, ON, THRU ON or FULL keys can also be modified by the wheel in the same way.

Channel Level Activity

The display of channel intensities on the VDU screens use different colours to identify what the channel is doing.

MAGENTA	Increasing in level
GREEN	Decreasing in level
BLUE	No change.
WHITE /RED BOX	Under Channel Control (current selection) on Output display.
WHITE / GREEN BOX	Under Channel Control (current selection) on Cue Preview or Submaster displays.
WHITE	Channels used on A/B Playback

Advanced Channel Control

The features covered in this section offer more advanced applications of the Genius Channel Control.

Stage Output

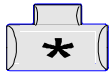

If the Channel Control has nothing selected then the complete output on stage is controlled via the wheel by simply pressing the * key. This will now make a CURRENT SELECTION of all channels which have a level above zero on stage (including running effects).

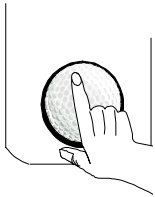

* <wheel> The whole output can now be wheeled to a desired level and this can be monitored in the OUTPUT display.

SOLO (MACRO +)

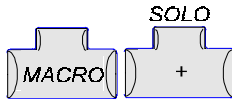

This toggle action key keeps the CURRENT SELECTION on stage whilst all other intensity channels including those from Playbacks, Submasters and Effects will temporarily go to zero.

The LED above the SOLO key will light up and flash as long as the function is active.

If channels 1 - 20 are on stage, selecting **4 THRU 6 SOLO*** (MACRO +) will keep channels 4, 5 and 6 on whilst all the other channels go to zero.

Pressing **SOLO *** (MACRO +) again will switch the output back to its previous state.

REMAINDER DIM (MACRO -)

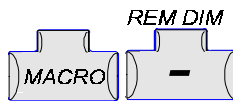

The CURRENT SELECTION will remain on stage whilst all other intensity channel outputs **permanently** go to zero.

The LED above the - key will light up briefly.

Unlike solo, which is a temporary measure, the actions taken with this command are permanent; however they can be undone by pressing the (MACRO @)UNDO key.

Tip: Remainder Dim is a useful aid for focussing and lamp checking

BUMP ↑ ↓ Keys

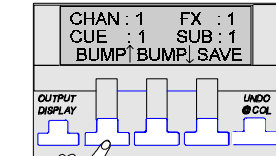

BUMP keys are 'hold on' action keys. The bump keys on the LCD menu have the following effect:-

BUMP ↑ -Press: Flashes the CURRENT SELECTION to FULL.
Release: Returns the selection to its previous levels.

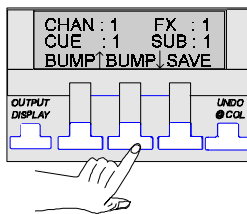

BUMP ↓ -Press: Puts the CURRENT SELECTION to ZERO.
Release: Returns the selection to its previous levels.

SAVE Key

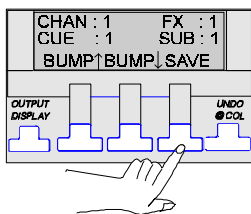

Controlling Cues in Channel Control

The SAVE key, when pressed will perform a quick save of all GSX memories (the entire show) to a loaded floppy disk.

If a show file already exists on the disk, it will be renamed as a backup before the new show file is saved.

Once cues have been recorded (see **Recording Cues** section) they can have their channel levels controlled by Channel Control. The following commands show some examples:-

CUE 1 @ 3

Will put all channel levels in Cue 1 to 30% of their recorded values.

CUE 1 <wheel>

Grabs Cue 1 channels at their current levels and allows these levels to be changed visually.

1 + CUE 5 @ 2

This will put all channels in Cue 5 to 20% of their recorded values and also put Channel 1 to 20% regardless of whether it is in that cue or not.

CUE 1 @ <wheel>

Grabs cue 1 channels at their recorded levels.

Proportional Vs Shaft Mastering

When using the wheel to change channel levels you have the choice of using PROPORTIONAL or SHAFT mastering. The differences between the two methods is explained below. The PROPORTIONAL method is the default setting.

Shaft Mastering

This is a theatrical term referring to an old mechanical method of changing a group of channel levels together.

To see how this works, change the Wheel Mastering setting in the SETUP screen to SHAFT and set channels as shown:-

CHANNELS	1	2	3	4	5	6	7	8	9	10
LEVELS	50	50	50	75	75	75	30	30	30	90

Key in **1 THRU 10** to become the CURRENT SELECTION

Move the wheel so as channels 1 to 3 are at 70, the rest of the channels will change as shown having an extra 20% **added** to their levels. Decreasing levels will, of course, subtract the same number of points from each channel's level.

CHANNELS	1	2	3	4	5	6	7	8	9	10
LEVELS	70	70	70	95	95	95	50	50	50	FL

(Channel 10 should in theory be at 110% but cannot go higher than full).

Proportional Mastering

Proportional mastering means that levels are changed proportionally to their current levels i.e. the number of points **added** or **subtracted** from each channel depends on the level it is at.

Reset the SETUP screen setting to PROPORTION and change channels to the following settings:-

CHANNELS	1	2	3	4	5	6	7	8	9	10
LEVELS	50	50	50	60	60	60	60	30	30	90

Key in **1 THRU 10**

Move the wheel so channels 1 to 3 are at 70 again. This now represents a 40% proportional increase and all other channel levels also increase proportionally by 40% of their previous levels:-

CHANNELS	1	2	3	4	5	6	7	8	9	10
LEVELS	70	70	70	84	84	84	84	42	42	FL

(Channel 10 in theory should be 126 but can not go higher than FL as this is the maximum).

Notes:-

Recording Cues

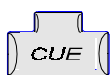

This section details the recording process used with Genius and demonstrates examples of commands in both DIRECT ACTION and COMMAND LINE modes.

Selecting a Cue

To select a cue number for recording or editing, the CUE key must be pressed before the cue number is entered.

Entering Commands

All commands are entered using the keypad. Genius responds to two types of command: DIRECT ACTION or COMMAND LINE.

DIRECT ACTION entries are shown typed in **BOLD UPPER CASE** lettering.

COMMAND LINE entries are shown in *ITALICS UPPER CASE* lettering.

You may select which type of command to work with using Channel Control mode in the SET-UP screen.

Direct Action Mode

In this mode as soon as enough keys are pressed to form a complete command, the command is carried out and an asterisk * (which is the ENTER symbol) is automatically added to the entry line on the VDU. Any subsequent entries will clear the entry line and start a new command sequence.

CUE 1 TIME 10 RECORD *

CUE 5.1 TIME 20 RECORD *

Command Line Mode

In this mode no action will take place until the * <enter> key is pressed. Using the same examples as above, the entries are keyed in as follows:-

*RECORD 1 TIME 10 < * >*

*RECORD 5.1 TIME 20 < * >*

The * key is shown in chevrons < * > to denote that this key must be pressed to complete the command.

*In COMMAND LINE mode RECORD 1 < * > is all that is required to enter cue 1; the command CUE can be left out.*

What is a Cue?

A cue, often referred to as a memory or preset, is a pre-recorded lighting state including associated fade, delay and wait times. This lighting state is set up manually by wheel or keypad and then recorded into internal memory as a numbered cue.

A maximum of 200 cues may be recorded either as whole numbers or with a decimal point; cues can be numbered from 1 to 999.9. In this way extra cues can be inserted between whole ones. For example between cue 1 and 2 you can insert 1.1, 1.2, 1.3 etc. right up to 1.9. The top display bar on all of the screens shows the number of free cues left. This information is stored in long term memory of the GSX and will be retained even when the console is switched off.

Recording a Cue

Once the required lighting state is set, a cue is recorded into memory using the CUE, RECORD and TIME keys. Changing from one cue to another is rarely an instant transition and it is usual to fade up and fade down cues over a period of time to achieve a smooth transition between scenes.

Up Fade and Down Fade times are associated with the current cue fading in on stage.

An Up Fade time refers to channels fading to higher levels in that cue.

A Down Fade time refers to channels that are required to fade to lower levels in that cue.



The RECORD key records levels and times into memory, the most basic command being:-

CUE 1 RECORD *
*RECORD 1 < * >*

This would record cue number 1 with the default fade times that have been programmed in the SET-UP screen.

REC-SUB



This key means RECORD less SUBMASTERS. It may be necessary to record cues while the house or other general lighting is on and as these are often assigned to Submasters, will have their levels displayed on the OUTPUT screen

These levels are not, of course, required in a cue and using REC-SUB instead of RECORD will ensure that no Submaster channel levels are recorded with the cue.

CUE 1 REC-SUB
*REC-SUB 1 < * >*

Recording Cues with Time

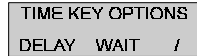

Genius identifies that a non-default time is to be inserted when the TIME key is pressed on the keypad. When activated the LED above the TIME key will flash and the LCD will change to show that F1, F2, F3 keys are now operating as DELAY, WAIT and SPLIT (/) keys.

These are covered later in this section. Unless one of these keys is pressed first, the entry will be interpreted as the fade up and fade down time, (entries made with a single number have the same fade up and fade down times).

CUE 2 TIME 15 RECORD *

*RECORD 2 TIME 15 < * >*

Cue 2 is recorded with a non-split 15 second fade time so when cue 2 is played back, all cue 2 channels will fade at the same time. All the channels in the previous cue will fade down in 15 seconds unless recorded as a MOVE fade, discussed overleaf.

Entering Time Values

Regardless of whether DOUBLE or SINGLE DIGIT format is set, times are always entered in the same way. Minutes as well as seconds can be entered as shown in the example formats below:-

- 1** 1 second
- 1.5** 1.5 seconds
- 12** 12 seconds
- 12.5** 12.5 seconds
- 123** 1 minute 23 seconds
- 123.5** 1 minute 23.5 seconds
- 1234** 12 minutes 34 seconds
- 1234.5** 12 minutes 34.5 seconds
- 5959** 59 minutes 59 seconds (Maximum entry)

RECORD TIME



The REC TIME key updates a cue's time settings only, without affecting the recorded levels.

CUE 2 TIME 12 REC TIME *

*REC TIME 2 TIME 12 < * >*

This would update the Cue 2 fade times to 12 seconds.

Types of Fade

There are two types of fade; these are the CROSSFADE (XF) and the MOVEFADE (MF).

All cue entries are treated as Crossfades unless the cue is prefixed by + which then identifies it as a Movefade.

CUE 1 TIME 10 RECORD * **Crossfade (XF)**

*RECORD 1 TIME 10 < * >*

CUE + 1 TIME 10 RECORD * **Movefade (MF)**

*RECORD + 1 TIME 10 < * >*

Crossfade

A crossfade will fade all the levels from one cue to the levels in another cue so that the latest cue only is on stage.

In the example below CUE 1 consists of 1, 2 and 3 at FULL

CUE 2 consists of 3 and 4 at FULL

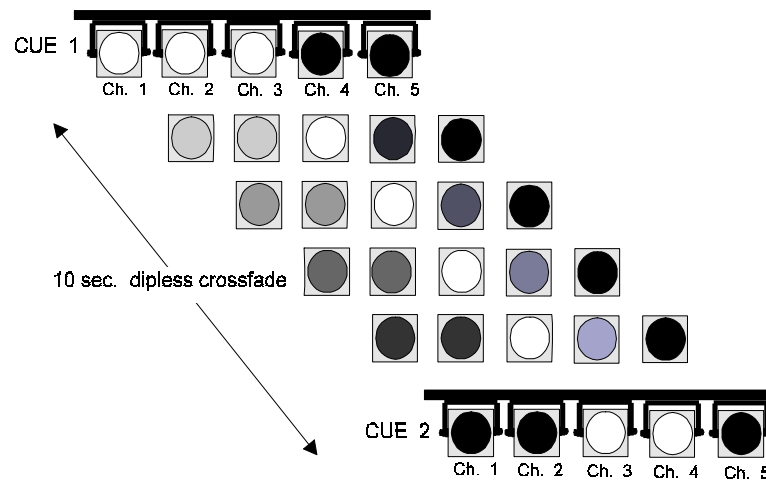

All Crossfades on Genius are 'dipless' which means that any channel that remains at the same level in both cues will not 'dip' when fading from one cue to the other. In the example shown channels 3 and 5 remain at the same levels throughout.

Movefades

A MOVEFADE adds lights to or subtracts lights from an existing output already on stage.

Following on from the Crossfade illustration,

CUE 2 is now on stage.

CUE +3 has been recorded to set 1, 2 and 5 at FULL but when cue +3 appears on stage it is added to the existing output and all lights are on at FULL.

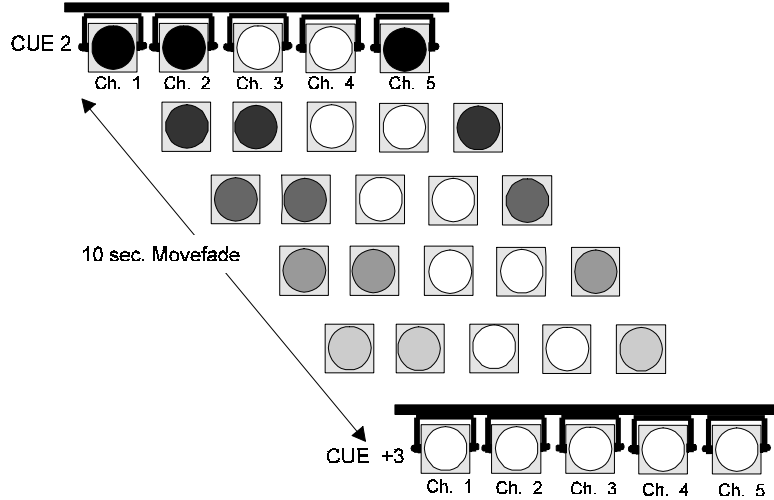

Up to 6 Movefades can be running simultaneously in the X Playback, any channel controlled by more than one of the Movefades will follow the latest Movefade.

Movefade to Zero

In the next cue Channel 3 is required to be switched off immediately. This is easily achieved by using a Movefade and setting channel 3 to zero with a zero time value as well.

Channel 3 is actually required to be ON AT ZERO. To achieve this go to the CUE PREVIEW screen and type in:-

3 @ 0 *
CUE + 4 TIME 0 RECORD *

3@ 0 <>*

*RECORD + 4 TIME 0 < * >*

Updating a Cue (MACRO CUE)

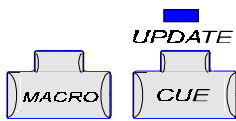

A cue can be updated by adding or modifying channels using the MACRO and CUE keys.

1 THRU 5 @ 7 *
MACRO CUE 5 RECORD *

*1 THRU 5 @ 70 < * >*
*MACRO CUE 5 < * >*

All channels controlled by Channel Control (red) are added to cue.

This will add channels 1 to 5 at 70% to the existing channels in cue 5. It does not affect the levels of any other channels in the cue.

If this cue was modified without using MACRO CUE all other channels in that cue would go to zero after an over-record warning appears.

Time Key Options

The following descriptions of the SPLIT (/), WAIT, DELAY keys are aided by graphs for easier understanding. To keep these graphs simple, all cues are assumed to have different channels.

Genius supports an X and an A/B Playback. Fades using the X Playback are always referred to as fade UP and fade DOWN, split fades are UP/DOWN fades with associated UP/DOWN times.

On the A/B Playback they are referred to as fade IN and fade OUT, split fades are IN/OUT fades with associated IN/OUT times, (see **Playback** section for explanation on differences).

The Playbacks referred to in this section assume an X Playback is being used but the fade times apply equally to the IN or OUT on the A/B Playback.

SPLIT (/)

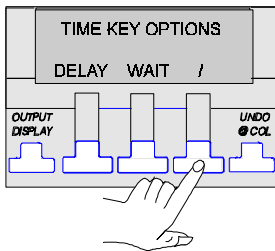

Pressing / allows the fade UP and fade DOWN times to be different.

CUE 2 TIME 10/15 RECORD *
*RECORD 2 TIME 10/15 < * >*

When played back (GO button pressed), channels in cue 2 moving up in level will fade UP in 10 seconds and channels required to move down in level will fade DOWN in 15 seconds.

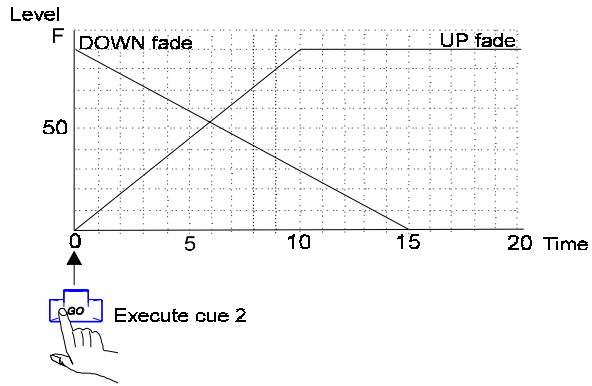

WAIT

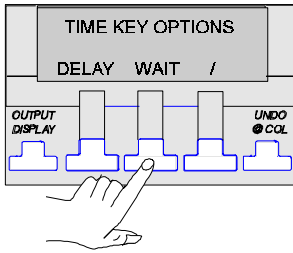

The WAIT time facility is a very powerful function and can be used to string together cues automatically. For example, Cue 1 consists of channel 1 @90%. Cue 2 consists of channel 2 @ 70%. The commands below will set up cues 1 and 2 so that cue 2 will automatically start following a WAIT time period.

CUE 1 TIME 3 WAIT 10 RECORD *
CUE 2 TIME 5 RECORD *

RECORD 1 TIME 3 WAIT 10 <>*
RECORD 2 TIME 5 <>*

Cues recorded with WAIT times mean that the following cue will start fading after that WAIT time has finished. In this way a timed sequence of fades can be started automatically with one press of the GO button.

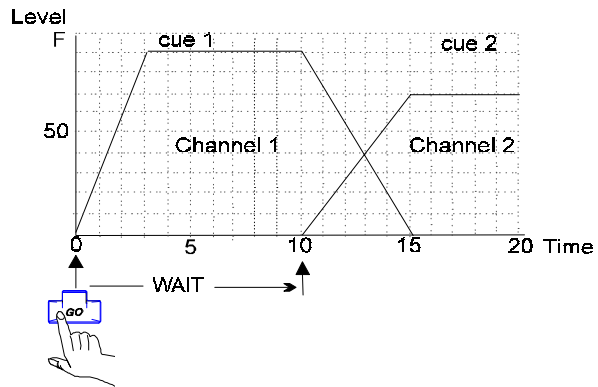

Up to 200 cues may be chained together. See page 59 for example of automatic operation.

DELAY

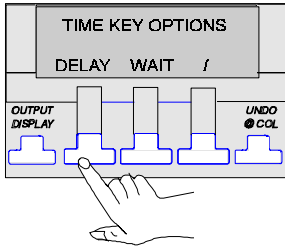

CUE 1 TIME 10 DELAY 5 RECORD *

*RECORD 1 TIME 10 DELAY 5 < * >*

When played back this will fade ALL the channels in cue 1 after a 5 second delay.

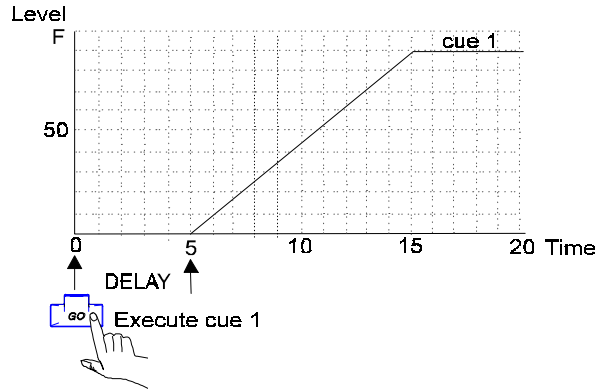

CUE 2 TIME 8 DELAY 5/10 RECORD *

*RECORD 2 TIME 8 DELAY 5/10 < * >*

When played back, this will fade UP the channels in cue 2 in 8 seconds after a 5 second delay, and fade DOWN the channels in cue 1, in 8 seconds after a 10 second delay.

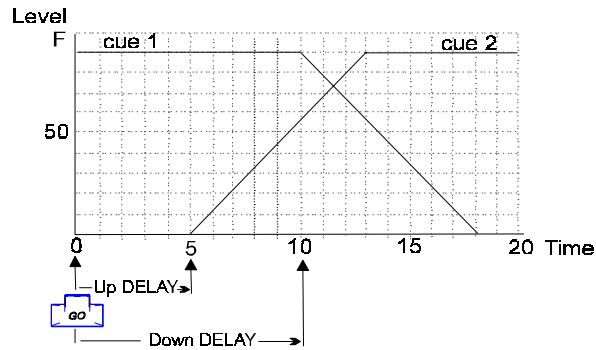

Cue Preview Screen

Up to now only the OUTPUT screen has been in use but once cues have been recorded, accessing the CUE PREVIEW SCREEN allows a number of editing functions to be performed on them. Editing cues not on stage is termed 'preview' or 'blind' editing. To access this screen follow the route shown below.

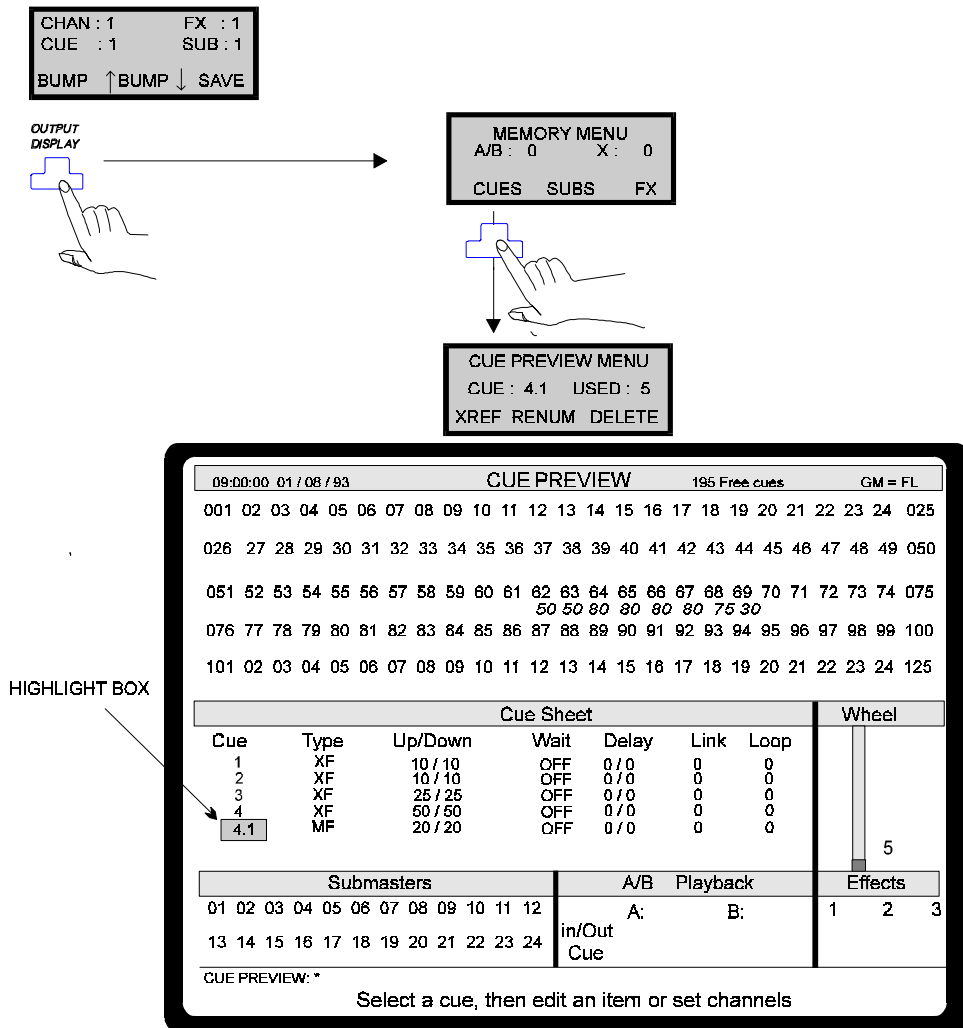

If no cues have been recorded, accessing the CUE PREVIEW screen will automatically record Cue 1 as a Crossfade with default fade times and no WAIT or DELAY times. All channels are unused.

Cue Sheet

Editing and copying is done in the CUE SHEET by using the wheel or the 4 cursor keys above it. All cues are viewed in the CUE SHEET by using a cursor or the wheel to scroll through them. The window holds 9 cues and is called a 'page' of the CUE SHEET.

Selecting Cues

When the highlight box is in the CUE field the following editing options are available:

- The up/down cursor keys will scroll through the cue list.
- The wheel will cause a new page of cues to appear. The wheel column always shows the position of the selected cue in the CUE SHEET.

Cursor keys - scroll up/down

Cue Sheet							Wheel
Cue	Type	Up/Down	Wait	Delay	Link	Loop	
1	XF	10 / 10	OFF	0 / 0	0	0	
2	XF	10 / 10	OFF	0 / 0	0	0	
3	XF	25 / 25	OFF	0 / 0	0	0	
4	XF	50 / 50	OFF	0 / 0	0	0	
5	MF	20 / 20	OFF	0 / 0	0	0	
6	XF	10 / 10	OFF	0 / 0	0	0	
7	XF	25 / 10	OFF	0 / 0	0	0	
8	XF	50 / 50	OFF	0 / 0	0	0	
9	MF	20 / 30	OFF	0 / 0	0	0	7

Wheel - go to next page of cues

Screen Editing

On-screen editing of cue TYPE and TIMES can be done in 4 ways:-

- WHEEL - changes values continuously up or down.
- + and - keys increase /decrease the displayed value by one.
- NEXT and LAST keys select the previous or next number, in sequence.
- TYPING NUMBERS replaces existing displayed values. (**Up/Down, Wait and Delay** only).

CLR when pressed will clear all changes to the selected value made with the WHEEL, +, -, NEXT and LAST keys.

CLR when pressed with typed entries will clear the last keystroke. When all keystrokes have been cleared, pressing CLR again will restore the field's original value.

Changing Recorded Levels

Channels and their respective levels can be modified without going back to the OUTPUT display. To change recorded levels the highlight box must be in the CUE field.

Cue Sheet							Wheel
Cue	Type	Up/Down	Wait	Delay	Link	Loop	
1	XF	10 / 10	OFF	0 / 0	0	0	
2	XF	10 / 10	OFF	0 / 0	0	0	
3	XF	25 / 25	OFF	0 / 0	0	0	
4	XF	50 / 50	OFF	0 / 0	0	0	
5	MF	20 / 20	OFF	0 / 0	0	0	
6	XF	10 / 10	OFF	0 / 0	0	0	
7	XF	25 / 10	OFF	0 / 0	0	0	
8	XF	50 / 50	OFF	0 / 0	0	0	
9	MF	20 / 30	OFF	0 / 0	0	0	9

CUE PREVIEW: 1 THRU 10@7 *

Select a cue, then edit an item or set channels

Modify channels 1 to 10 in cue 9

When modifying levels in this mode the @ key must be used and not the wheel. Selected channels are highlighted in green to differentiate them from the OUTPUT display. This also indicates that the wheel can't be used for setting preview levels.

Changing Recorded Times and Fade Times

By moving the highlight box around the various fields with the cursor keys, cues can have all their times and type of fade modified using the wheel or keypad.

Change fade up time of cue 3

Cue Sheet							Wheel
Cue	Type	Up/Down	Wait	Delay	Link	Loop	
1	XF	10 / 10	OFF	0 / 0	0	0	
2	XF	10 / 10	OFF	0 / 0	0	0	
3	XF	25 / 25	OFF	0 / 0	0	0	
4	XF	50 / 50	OFF	0 / 0	0	0	
5	MF	20 / 20	OFF	0 / 0	0	0	
6	XF	10 / 10	OFF	0 / 0	0	0	
7	XF	25 / 10	OFF	0 / 0	0	0	
8	XF	50 / 50	OFF	0 / 0	0	0	
9	MF	20 / 30	OFF	0 / 0	0	0	3

Cue Sheet							Wheel
Cue	Type	Up/Down	Wait	Delay	Link	Loop	
1	XF	10 / 10	OFF	0 / 0	0	0	
2	XF	10 / 10	OFF	0 / 0	0	0	
3	XF	25 / 25	OFF	0 / 0	0	0	
4	XF	50 / 50	OFF	0 / 0	0	0	
5	MF	20 / 20	OFF	0 / 0	0	0	
6	XF	10 / 10	OFF	0 / 0	0	0	
7	XF	25 / 10	OFF	0 / 0	0	0	
8	XF	50 / 50	OFF	0 / 0	0	0	
9	MF	20 / 30	OFF	0 / 0	0	0	7

Change fade type of cue 7

Copying cues

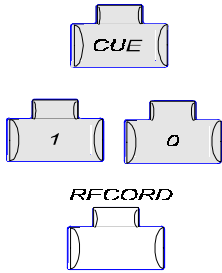

Cues can be copied and added to the cue list, only when in this screen. The diagram below shows cue 10 being recorded as a copy of cue 7. This is achieved by highlighting the cue you require to be copied and then recording it as the next cue in sequence.

CUE 10 RECORD *
RECORD 10 <*>

Cue Sheet							Wheel
Cue	Type	Up/Down	Wait	Delay	Link	Loop	
1	XF	10 / 10	OFF	0 / 0	0	0	
2	XF	10 / 10	OFF	0 / 0	0	0	
3	XF	25 / 25	OFF	0 / 0	0	0	
4	XF	50 / 50	OFF	0 / 0	0	0	
5	MF	20 / 20	OFF	0 / 0	0	0	
6	XF	10 / 10	OFF	0 / 0	0	0	
7	XF	25 / 10	OFF	0 / 0	0	0	
8	XF	50 / 50	OFF	0 / 0	0	0	
9	MF	20 / 30	OFF	0 / 0	0	0	7

CUE PREVIEW: **CUE 10 COPY ***

Select a cue, then edit an item or set channels

RECORD key pressed

Instead of RECORD, COPY will appear in the command line.

Links and Loops

Normally when cues are played back they will follow in sequential order, however the Link facility allows you to change the order to suit your own requirements. e.g. the diagram below shows two 'Links' being inserted in Cue 3 and Cue 9.

Cue Sheet							Wheel
Cue	Type	Up/Down	Wait	Delay	Link	Loop	
1	XF	10 / 10	OFF	0 / 0	0	0	
2	XF	10 / 10	OFF	0 / 0	0	0	
3	XF	25 / 25	OFF	0 / 0	6	0	
4	XF	50 / 50	OFF	0 / 0	0	0	
5	MF	20 / 20	OFF	0 / 0	0	0	
6	XF	10 / 10	OFF	0 / 0	0	0	
7	XF	25 / 10	OFF	0 / 0	0	0	
8	XF	50 / 50	OFF	0 / 0	0	0	
9	MF	20 / 30	OFF	0 / 0	2	0	9

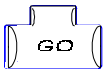
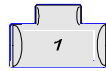
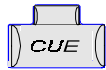

Cues are played back by pressing **CUE 1** on the keypad and **GO** on the Playback unit. Pressing **GO** continuously steps through the Cue Sheet in sequence.

In this case the next Cue to follow Cue 3 will be Cue 6. The cues then continue in sequence until the list reaches Cue 9 after which the next Cue to playback will be Cue 2.

The Loop facility works in conjunction with Links and allows the same cues to be played back repeatedly.

Cue Sheet							Wheel
Cue	Type	Up/Down	Wait	Delay	Link	Loop	
1	XF	10 / 10	OFF	0 / 0	0	0	
2	XF	10 / 10	OFF	0 / 0	0	0	
3	XF	25 / 25	OFF	0 / 0	6	3	
4	XF	50 / 50	OFF	0 / 0	0	0	
5	MF	20 / 20	OFF	0 / 0	0	0	
6	XF	10 / 10	OFF	0 / 0	0	0	
7	XF	25 / 10	OFF	0 / 0	0	0	
8	XF	50 / 50	OFF	0 / 0	0	0	
9	MF	20 / 30	OFF	0 / 0	2	0	9

e.g. if a 'Loop' setting of 3 was now added to the arrangement, the Cue list would operate as follows:-

Cue 1-2-3-6-7-8-9

Cue 2-3-6-7-8-9 This sequence would repeat 3 times. On the 4th time around the sequence would go like this:-

Cue 2-3-4-5-6-7-8-9 The loop figure has been achieved and now the sequence reverts to sequential operation.

A zero setting in the Loop column should be regarded as infinite. In the diagram above Cue 9 will always return to Cue 2 unless a positive number is inserted in the Loop column (max. 254) or the Link is removed.

Links, Loops and Chases

By combining a Wait time with the Link and Loop facility, chase effects can be achieved.

Cue Sheet							Wheel
Cue	Type	Up/Down	Wait	Delay	Link	Loop	
1	XF	1 / 1	1	0 / 0	0	0	
2	XF	1 / 1	1	0 / 0	0	0	
3	XF	1 / 1	1	0 / 0	6	0	
4	XF	1 / 1	1	0 / 0	0	0	
5	MF	1 / 1	1	0 / 0	0	0	
6	XF	1 / 1	1	0 / 0	0	0	
7	XF	1 / 1	1	0 / 0	0	0	
8	XF	1 / 1	1	0 / 0	0	0	
9	MF	1 / 1	1	0 / 0	2	0	9

In the diagram above, a Wait time of 1 second has been assigned to Cues 1-9.

The fade times are set to 1 second, the Loop has been removed but the Link remains.

When played back the cues will operate in a similar manner to a chase effect.

To stop the chase re-cycling, remove the link i.e. set it to zero. Also set the Wait time to OFF to resume normal cue sequencing.

By adding a loop somewhere in the Cue list varied and complex sequences are possible.

DELETE

```
CUE PREVIEW MENU
CUE : 4.1  USED : 5
XREF RENUM DELETE
```

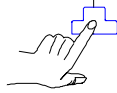

Deletes the cue and removes the number from the cue list. Operates on the selected cue or a range of cues if THRU is used.

DELETE deletes selected cue.

CUE 1 THRU 5 DELETE (no enter key required) deletes all cues from 1 to 5 including those with decimal points.

RENUMBER

Use this feature with care as it renumbers a range of cues.

```
CUE PREVIEW MENU
CUE : 4.1  USED : 5
XREF RENUM DELETE
```

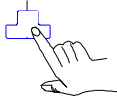

RENUM renumbers the whole CUE SHEET starting at 1 including decimal point cues. The renumbered cues will be 1,2,3, etc.

CUE 1 THRU 5 RENUM renumbers, in the case of the screen shown on the previous page, cues 1 to 5 including the decimal point cue 4.1.

CUE 200 THRU 210 RENUM will renumber that range as consecutive cues starting at 200.

Cues before renumbering: 200, 201, 201.1, 201.2, 207

Cues after renumbering: 200, 201, 202, 203, 204

Xref Screen

The Cue Cross Reference screen shows an alternative display of cues in memory, replacing the channel grid window with the channels for several cues at once. This is used to show channel changes in each cue.

- Cues - vertical row.
- Channels - horizontal row

Scrolling the cue sheet with the $\uparrow\downarrow$ keys or wheel also scrolls the XREF window.

F1 and F3 scroll through channels horizontally so that a cue's contents can be monitored quickly.

To access the screen, follow the procedure shown below.

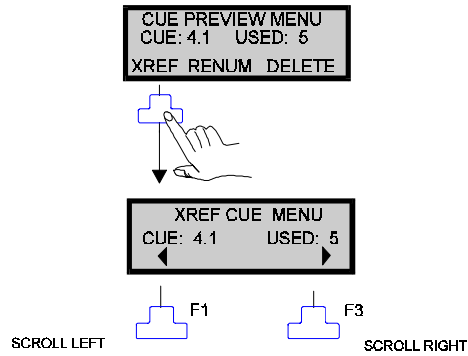

09:00:00 01/08/93 CUE XREF PREVIEW 195 Free cues GM = FL

026 27 28 29 30 31 32 33 34 35 36 37 38 39 40 41 42 43 44 45 46 47 48 49 050

1 FL FL FL FL 70 FL FL FL FL 85 85 85 85

2

3 FL FL FL FL 70

4

4.1 40 40 40 50 50

026 27 28 29 30 31 32 33 34 35 36 37 38 39 40 41 42 43 44 45 46 47 48 49 050

Cue Sheet							Wheel
Cue	Type	Up/Down	Wait	Delay	Link	Loop	
1	XF	10 / 10	OFF	0 / 0	0	0	
2	XF	10 / 10	OFF	0 / 0	0	0	
3	XF	25 / 25	OFF	0 / 0	0	0	
4	XF	50 / 50	OFF	0 / 0	0	0	
4.1	MF	20 / 20	OFF	0 / 0	0	0	5

Submasters												A/B	Playback	Effects			
01	02	03	04	05	06	07	08	09	10	11	12		A:	B:	1	2	3
13	14	15	16	17	18	19	20	21	22	23	24	In / Out					
Cue																	

CUE PREVIEW: ^

Select a cue, then edit an item or set channels

Notes

Playbacks

GSX has two playbacks:-

- **X Playback** - An automatic playback.
Cues are executed by pressing the GO key which fades in successive cues that have been pre-recorded in a sequence. Fade times are termed as fade UP and fade DOWN.
- **A/B Playback** - A manual playback.
Cues are executed by moving the Playback faders. Fade times are termed as fade IN and fade OUT.

Each playback has a bank of LEDs to monitor the progress of fades.

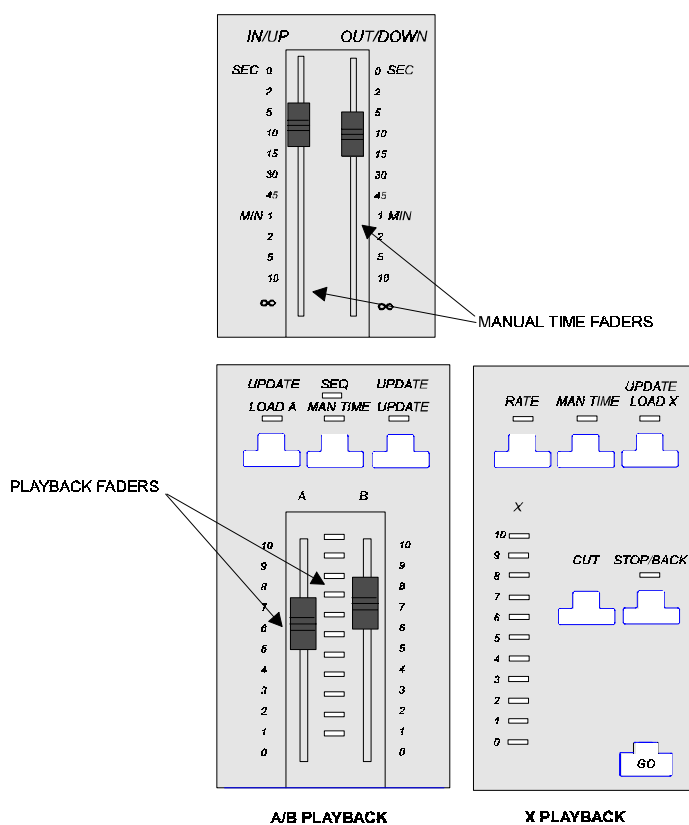

A total of six Movefades can be run simultaneously on the X Playback. The manual time faders can control fade times for both A/B and X Playbacks. Each Playback can fade cues manually or with any recorded times. To use the manual time faders, select MAN TIME on the X or A/B Playback panel.

Only Cues can be loaded onto the A, B or X playback. If an attempt is made to load a non-existent cue, a warning is given.

X Playback

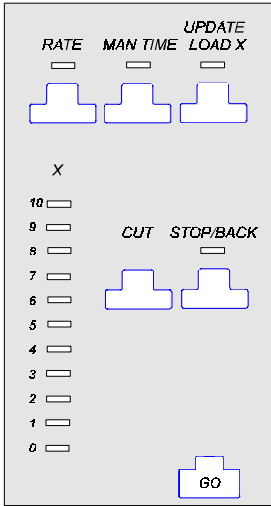

The X playback always operates in sequence mode. Fade UP controls channels increasing in intensity during the cue. Fade DOWN controls those decreasing.

The playback consists of the following key functions:-

- **RATE** Allows the speed of the fade to be adjusted by the wheel
- **MAN TIME** Use manual time faders, not recorded time
- **LOAD X** Loads selected cue
- **CUT** Transfers selected cue to output instantly
- **STOP/BACK** Stops or reverses a fade
- **GO** Runs the cue

Each cue is played back as recorded in the CUE SHEET with any WAIT or DELAY times that apply as long as MAN TIME is not selected.

The + symbol which denotes a movefade is only recognised by the X Playback, the A/B type performs Crossfades only.

GO



This starts a fade on the X playback.

If no cue has been loaded with the LOAD X key, the next cue in the CUE SHEET is loaded. Continuous pressing of GO will step through all the cues sequentially in the CUE SHEET.

Cues can be loaded out of sequence by either using the CUE xx GO method or via LOAD X as described overleaf.

CUE xx GO

CUE 25 GO for example, will allow a fast 'load and go' operation and output that cue to stage directly with any appropriate fade times. This is the equivalent of keying in CUE 25 LOAD X GO.

Pressing GO again would now put the next cue in the sequence on stage.

CUT

CUT



Selects the next cue in the CUE SHEET and outputs it to stage instantly with user defined cut times.

CUE xx CUT

As above except that xx becomes the transferred cue.

CUE xx LOAD X

LOAD X



This key allows cues to be loaded out of sequence but does not put them on stage until the GO button is pressed. The cue is first selected on the **Channel Control** and then LOAD X loads it into Playback X after which, GO executes it.

Any subsequent GO actions will now step through the CUE SHEET from that cue onwards.

For example:-

CUE 50 LOAD X

GO : puts cue 50 on stage

GO : will now put cue 51 on stage (assuming that is the next cue).

The LED above the key lights up when a cue is loaded.

RATE

RATE



This key is only active when held down and, when active, the wheel is used to control the fade times of all fading cues on the X playback and changes existing loaded values. If no cue is fading, the wheel controls any DELAY times running or if there are none, any WAIT times running. If no FADE, DELAY or WAIT times are running wheeling the RATE key has no effect.

The RATE key is for real time modifications and on releasing the key changes will remain on stage but will not affect the recorded cue times on a permanent basis.

Adjustment range can be wheeled from 0 - infinity.

MAN TIME

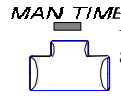

This key works as a toggle action and when active, (LED on), recorded times are ignored and fade times are taken from the Manual Time faders. When inactive, (LED off), recorded times are used.

Recorded WAIT and DELAY times are ignored.

STOP/BACK



On the first press, (LED on), any fades that are running will stop.

On the second press, (LED flashes on), the last fade is REVERSED if it is still running. If no fades are running then the previous cue from the CUE SHEET is cross faded onto stage with the **X Back** fade time that has been set in the SET-UP screen.

Continuously pressing this key will step through cues in the CUE SHEET in reverse order using the **X Back** time.

Press GO or CUT to disable this function and restore normal sequencing, (LED goes out).

MAN TIME overrides the SETUP display Back Time

A/B Playback

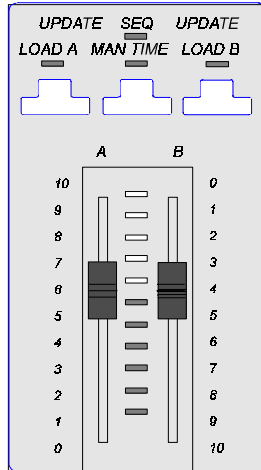

The A/B playback is a two scene dipless manual crossfader which means that if the faders are moved together a smooth and even crossfade occurs between the lighting scene loaded in the A store and that in the B.

Fade IN time is the time taken for the cue in A to appear fully. Fade OUT time is the time taken for the cue in A to fade out completely.

If A and B masters are both at 10, then both cues will be 'Live' with common channels set to the Highest level.

The A/B playback consists of the following:-

- LOAD A Loads selected Cue
- LOAD B Loads selected Cue
- MAN TIME / SEQ Uses manual time faders, and/or enables sequence mode
- A and B crossfaders Performs a Crossfade

The current states are identified by the LEDs above each key.

LOAD A LOAD B

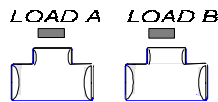

The LOAD A and LOAD B keys are used to load a cue (entered on the keypad) directly into either the A or B Playback, allowing cues to be loaded live (if the appropriate fader is greater than 0) or blind (if the fader is at 0).

When a Cue is present on either the A or B playback the corresponding LED above the LOAD keys will be on and the loaded Cue number displayed in the LCD.

Entries are made in the following order:-

<CUE> number <LOAD A(B)>

CUE 10 LOAD A * : will load Cue 10 into the A Playback.

CUE 20 LOAD B * : will load Cue 20 into the B Playback.

A/B faders

These faders have to be moved every time a cue change is required. The time it takes for cues to be faded IN and faded OUT on stage is dependent on which MAN TIME /SEQ setting is active at the time.

Crossfades are always performed with both faders being moved together as one starts at 0 and the other at 10.

Moving one of the faders, B for instance, means the fader now acts as a master level controller for the cue loaded into that store.

MAN TIME/SEQ

ON

OFF

This key selects the A/B Playback mode by cycling through four operating states.

The operating status is denoted by the LEDs as shown in the side figures.



- **Playback with recorded time** - fades the loaded cues only with the times they were recorded with after the fader has been moved.

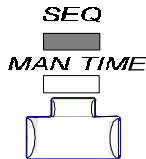

- **Playback Sequence with recorded time** - plays back cues listed sequentially in the CUE SHEET with their recorded times. On completion of one fade the next cue is automatically loaded into the 'Blind store' of the Playback ready for the next fade.

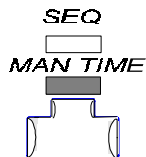

- **Playback with manual time** - plays back loaded cues only without any recorded times. The fade times are controlled either by the time set on the MANUAL TIME faders or if this is set to zero the fade can be controlled manually from the A/B faders.

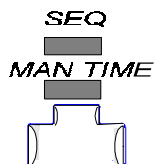

- **Playback Sequence with manual time** - sequentially plays back cues listed in the CUE SHEET without their recorded times in the same way as **Playback with manual time**. The next sequential cue is automatically loaded into the Playback's 'Blind store'.

The A/B Playback ignores DELAY and WAIT times, which are only used on the X Playback.

Running Fades Together

Playback X is fully automatic and up to 6 Move fades can be run simultaneously.

A/B and X can be used simultaneously or independently and both work on an HTP basis with the stage output.

Movefades can be run together with an existing crossfade but if another crossfade is added it will always over-ride all running fades.

Blackout Key

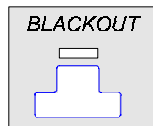

The Blackout key is of the toggle type, when active (LED flashing) the key will extinguish all lighting channels controlled by the console instantly and restore them again when pressed a second time.

Grand Master

The Grand Master has overall control of all lighting channel levels.

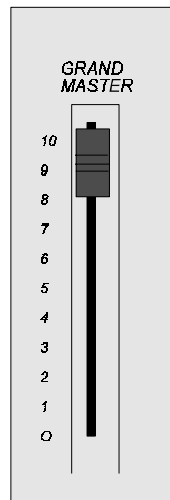

Notes

Submasters

A Submaster is a memory where channels may be recorded and controlled locally by means of a dedicated fader. Submasters are used to manually master (proportionally adjust) the levels of all channels recorded in that memory. Each Submaster can be assigned a separate fade time. The channels and levels recorded in the Submaster are retained by the console and recorded to disk as part of the show.

Any combination of the following may be recorded into a Submaster:

- Channels
- Cues
- Other Submasters

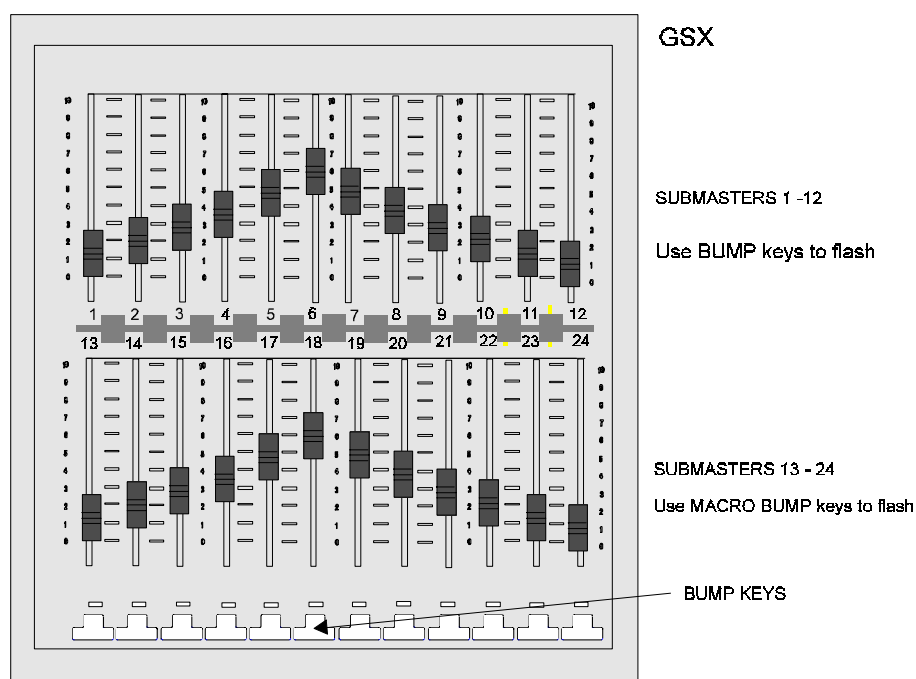

GSX has a total of 24 Submasters in two banks of twelve.

Bump keys will flash up all the channels in a particular Submaster to a set level governed by the FLASH LEVEL fader (covered later) The LEDs above them indicates a Submaster is on stage.

Submasters 1 through 12 are activated by just holding down the appropriate Bump key.

Submasters 13 through 24 are flashed by holding down the MACRO and appropriate Bump keys.

Recording Submasters

Channels are input through the Channel Control. This selection is then recorded into any specified Submaster by keying in the Submaster number and pressing the record key.

SUB 10 RECORD * Records the output into submaster 10.
*RECORD SUB 10 < * >*

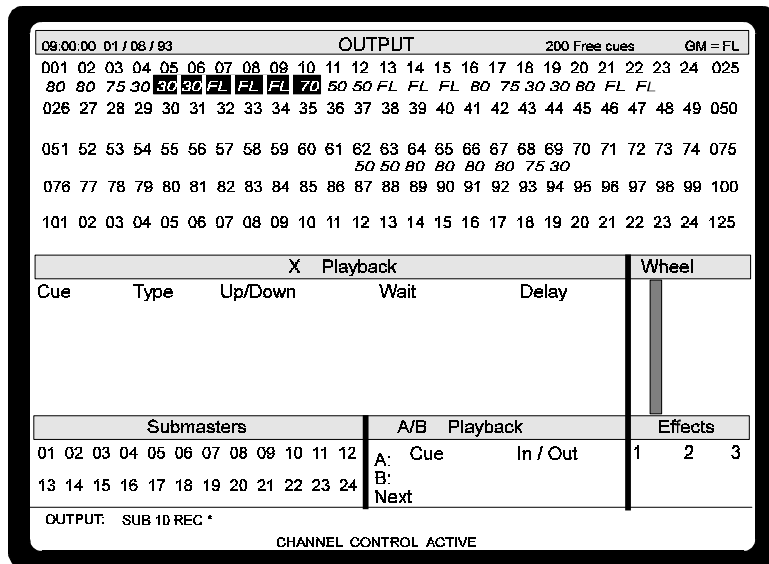

In the figure above, all channels that have a level will be recorded into Submaster 10 and not just the highlighted CURRENT SELECTION.

By recording an empty OUTPUT screen into a Submaster, that Submaster is cleared.

Alternatively the bump keys can be used to select the Submaster directly:-

SUB <BUMP> Records into appropriate Submaster.
SUB <BUMP>

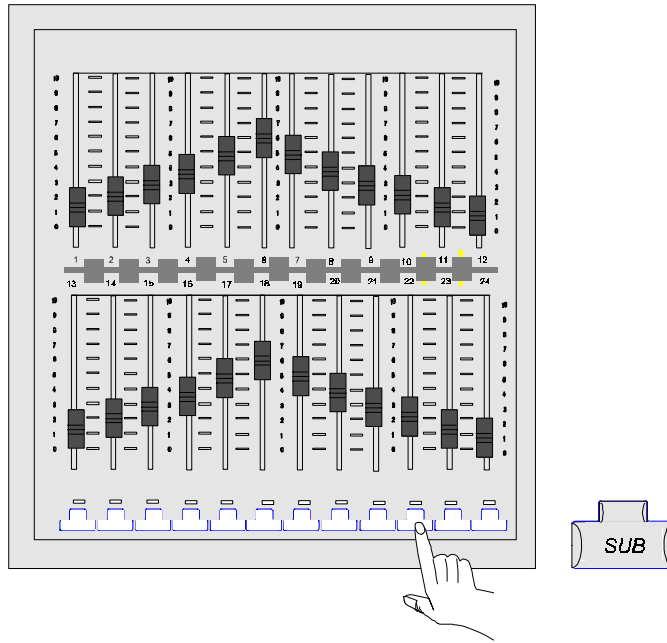

Unlike recording cues, there is no over record warning when recording Submasters

Setting Times



With default recorded times the Submaster contents will be faded in manually by the movement of the Submaster fader. Alternatively the SUB command can be supplemented with a TIME command for both fade in and fade out values.

SUB 12 TIME 10 RECORD *
*RECORD SUB 12 TIME 10 < * >*

SUB 10 TIME 5/8 RECORD *
*RECORD SUB 10 TIME 5/8 < * >*

Previewing Submasters

Submaster contents can be viewed and edited in the SUBMASTERS screen. The menu access route is shown in the figure below.

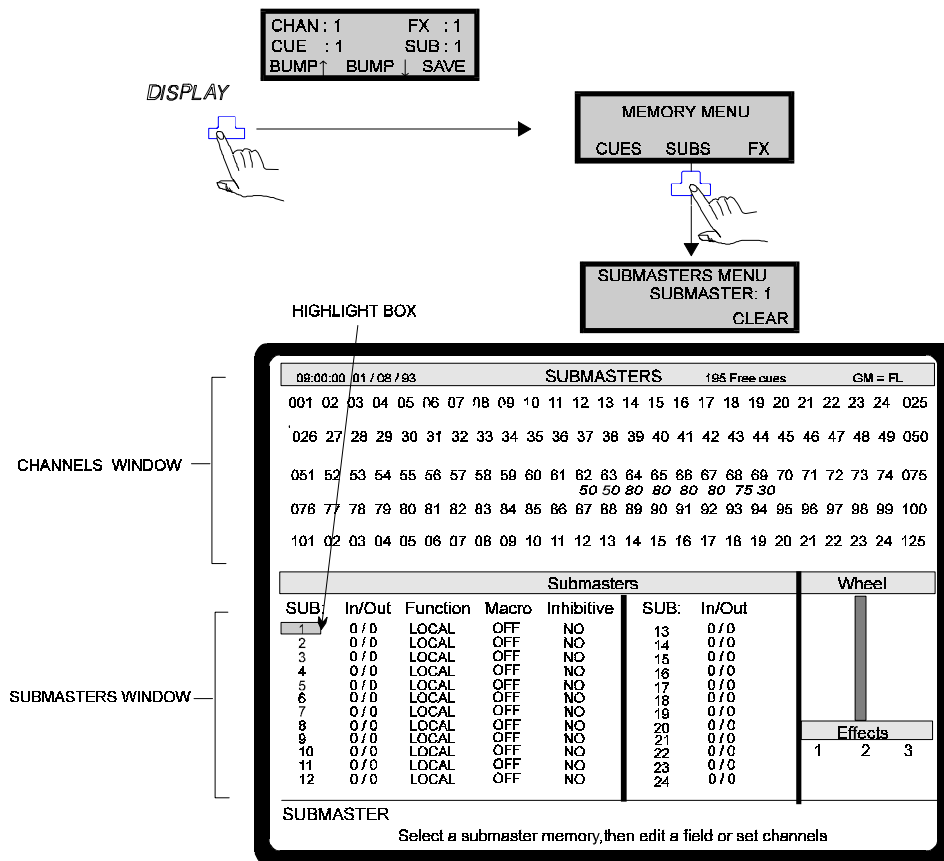

Use the directional cursor keys above the wheel to move the highlight box around the screen.

Editing in the channels window can only be achieved when the highlight box is over the selected Submaster number. This is done by keying in new channels and levels using normal Channel Control commands such as **1 @FULL** etc. The wheel has no effect here.

However, the wheel can be used to change values in the Submasters window in a similar manner to other screens.

Changes made in this screen overwrite instantly with no re-record warning.

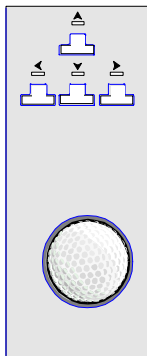

Submaster Fields **In/Out** refers to fade in/ fade out times.

Function refers to the type of Submaster used, which in the Genius package will be 'Local'.

Macro and **Inhibitive** types, are covered in the **Advanced Submasters** section.

Clear

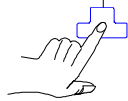

When pressed on its own, clears all channels and times in the selected Submaster memory. If preceded by a number or THRU list, it clears one or more memories, e.g. If SUB 1 is highlighted CLEAR erases it.

SUB 1 CLEAR Has the same effect.

SUB 1 THRU 3 Erases Submasters 1, 2 and 3.

Flashing up Submasters

When a Submaster is flashed on, the level and how it comes on is decided by the settings on the FLASH/SOLO panel.

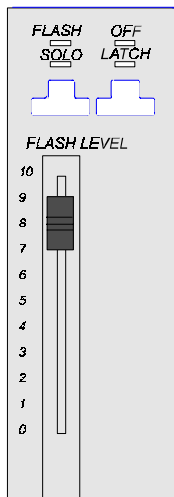

FLASH OFF **Off** is the default, if this red LED is on Bump keys have no effect.
SOLO LATCH

FLASH OFF **Flash** puts the Submaster contents on at the level indicated by the position of the FLASH LEVEL fader.
SOLO LATCH

FLASH OFF **Solo/Flash** puts the Submaster contents on as above but all other channels go to zero.
SOLO LATCH

FLASH OFF **Latch** can be used together with flash or solo and allows the bump keys to operate as a toggle, press for ON press for OFF, when the LED is on, the Bump key is latched on.
SOLO LATCH

FLASH OFF **Solo** puts all other channels to zero but leaves the submaster channels on. Effective only when Submaster channels are already on.
SOLO LATCH

Updating Submasters

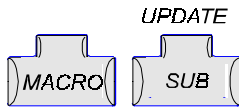

As modifications made in the Submaster screen take effect immediately, there is no further recording action required. However, a Submaster can also be modified whilst in the OUTPUT screen as follows:-

Pressing MACRO SUB will update a Submaster, for example

1 THRU 3 <wheel to level>MACRO SUB 4 RECORD *
1THRU 3<wheel to level>RECORD MACRO SUB 4 <.>*

will add channels 1 to 3 to Submaster 4 and re-record without affecting the other channels in the submaster.

Advanced Submaster use

This section details the more advanced uses of Submasters.

Inhibitive Submasters

Normal Submasters work on a HTP basis with the stage output, so if the same channels are in a Submaster and also happen to be on stage, then moving the Submaster fader will have no affect unless the Submaster output becomes higher than that on stage.

An Inhibitive Submaster works as a proportional master, which means that channels in a Submaster that also happen to be on stage can now be moved, up or down, by the Submaster fader.

Only Submasters 1 - 12 may be set to Inhibitive via the Submaster screen. To fully understand this feature follow the exercise below:-

1. Set up channels **10 THRU 15 @ 9** on the OUTPUT screen.
2. Go to SUBMASTERS screen and select Submaster.1
3. Set up **1THRU 25 @ 9**
4. Return to OUTPUT screen and raise submaster Fader 1. Observe channels 10 - 15, they remain at the same level.
5. Return to SUBMASTERS screen and move the highlight box to the **Inhibit** field and wheel to YES.
6. Return once again to the OUTPUT screen and observe the channels now when the fader is moved.

Channel levels assigned to Inhibitive Submasters have no meaning and are ignored. The red boxes just serve to show which channels are mastered by the inhibitive Submasters status window. Only the channels on stage have their levels displayed and these are now fully under control of the Submaster fader.

Inhibitive Submaster will be marked as **I** on the OUTPUT screen.

The Grand Master and Blackout have overall control of the Inhibitive Submasters.

Triggering Macros.

Submasters 1 to 12 may be configured to trigger any user defined macro (for information on **Macros** see chapter 11).

1. In the Submasters window, assign the Macro number (0-9) to the Macro field of the appropriate Submaster (see example below).
2. Move the Submaster fader off zero to activate the macro.

The fader acts as a trigger only and does not control the macro in any way.

Submaster Examples

The figure below shows the SUBMASTER and OUTPUT screen sections with the following Submaster configurations:-

7. TRIGGER MACRO 5
10. INHIBITIVE
11. INHIBITIVE
14. 5 second FADE IN / 8 second FADE OUT
15. 10 second FADE IN / 30 second FADE OUT

Submasters					
SUB:	In/Out	Function	Macro	Inhibitive	SUB: In/Out
1	0/0	LOCAL	OFF	NO	13 0/0
2	0/0	LOCAL	OFF	NO	14 05/08
3	0/0	LOCAL	OFF	NO	15 10/30
4	0/0	LOCAL	OFF	NO	16 0/0
5	0/0	LOCAL	OFF	NO	17 0/0
6	0/0	LOCAL	OFF	NO	18 0/0
7	0/0	LOCAL	5	NO	19 0/0
8	0/0	LOCAL	OFF	NO	20 0/0
9	0/0	LOCAL	OFF	NO	21 0/0
10	0/0	LOCAL	OFF	YES	22 0/0
11	0/0	LOCAL	OFF	YES	23 0/0
12	0/0	LOCAL	OFF	NO	24 0/0

SUBMASTERS SCREEN

SUBMASTERS											
01	02	03	04	05	06	07	08	09	10	11	12
13	14	15	16	17	18	19	20	21	22	23	24

OUTPUT SCREEN

Notes:-

Patch

The patch facility is used to assign channels to dimmer mux outputs as follows:-

- Intensity Channels - scaling from 0 - 200%
- Non Dim Channels - fixed level settings at 1 - 100%

Each channel may be 'patched' to more than one dimmer, but each dimmer can only be patched to one channel. The default setting for this is 1:1 whereby channel 1 is patched to mux dimmer 1, channel 100 is patched to dimmer output 100 etc.

All patching is modified in the PATCH screen menu.

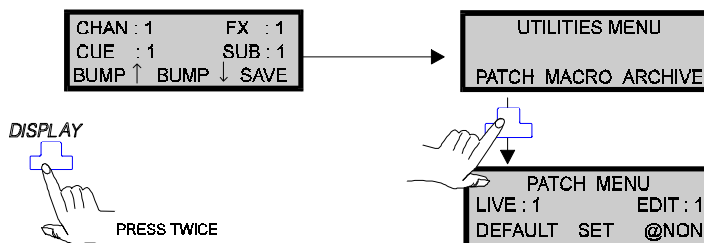

06:00:00 01 / 08 / 83 PATCH 185 Free cues GM = FL

DIM 1	2	3	4	5	6	7	8	9	10	11	12
CHN 1	2	3	4	5	6	7	8	9	10	11	12
100%	100%	100%	100%	100%	100%	100%	100%	100%	100%	100%	100%
DIM 13	14	15	16	17	18	19	20	21	22	23	24
CHN 13	14	15	16	17	18	19	20	21	22	23	24
100%	100%	100%	100%	100%	100%	100%	100%	100%	100%	100%	100%
DIM 25	26	27	28	29	30	31	32	33	34	35	36
CHN 25	26	27	28	29	30	31	32	33	34	35	36
100%	100%	100%	100%	100%	100%	100%	100%	100%	100%	100%	100%
DIM 37	38	39	40	41	42	43	44	45	46	47	48
CHN 37	38	39	40	41	42	43	44	45	46	47	48
100%	100%	100%	100%	100%	100%	100%	100%	100%	100%	100%	100%
DIM 49	50	51	52	53	54	55	56	57	58	59	60
CHN 49	50	51	52	53	54	55	56	57	58	59	60
100%	100%	100%	100%	100%	100%	100%	100%	100%	100%	100%	100%
DIM 61	62	63	64	65	66	67	68	69	70	71	72
CHN 61	62	63	64	65	66	67	68	69	70	71	72
100%	100%	100%	100%	100%	100%	100%	100%	100%	100%	100%	100%
DIM 73	74	75	76	77	78	79	80	81	82	83	84
CHN 73	74	75	76	77	78	79	80	81	82	83	84
100%	100%	100%	100%	100%	100%	100%	100%	100%	100%	100%	100%

PATCH: Select patch for level, Colour and Non-dim channels

Labels: SCALING FACTOR (points to 100% values), wheel (points to vertical slider), PAGE NUMBER (points to 1)

The display can be scrolled by using the wheel to view channels or dimmers in other pages. The page number is indicated at the bottom of the wheel column.

Scaling

An intensity channel has a default scaling of 100% meaning that channels patched to FULL will always be at 100% (maximum output). Situations often occur where a group of lamps, controlled by different dimmers, may be required to work together on one channel to give a balanced output, a blue wash in a cyclorama for instance. When the fader is at 100% the output looks uneven, represented in the diagram as varying dimmer output levels. In order to balance up these outputs scaling is used.

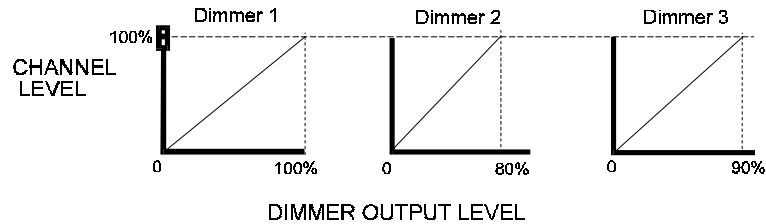

To achieve this balance the scaling factor on the PATCH screen needs to be changed for Dimmers 1 and 3 so that all lamps 'appear' to be the same brightness. In practice this would be set by trial and error and judged by eye, the graph below shows a representation of what happens to the dimmer outputs after scaling. Dimmer 2 cannot go higher than its 80% output so the other two have to be scaled downwards to match up.

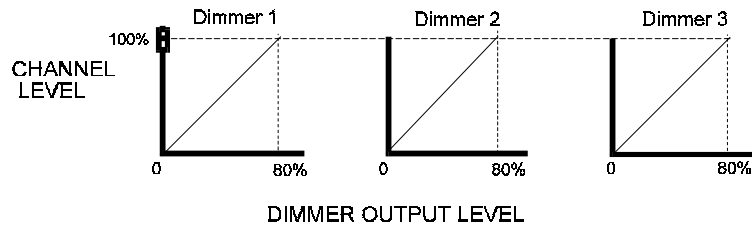

The actual commands for setting up scaling values are shown in the **Patching Dimmers** section.

The scaling factor may be set to any level up to 200%. Scaling over 100% does not mean that the output is actually doubled but will have the effect of making one of the lamps in a particular fade reach full brightness before the other.

The diagram below shows a 5 second fade with two lamps. Lamp 1 is scaled at 150% and reaches full brightness one and a half times quicker than Lamp 2.

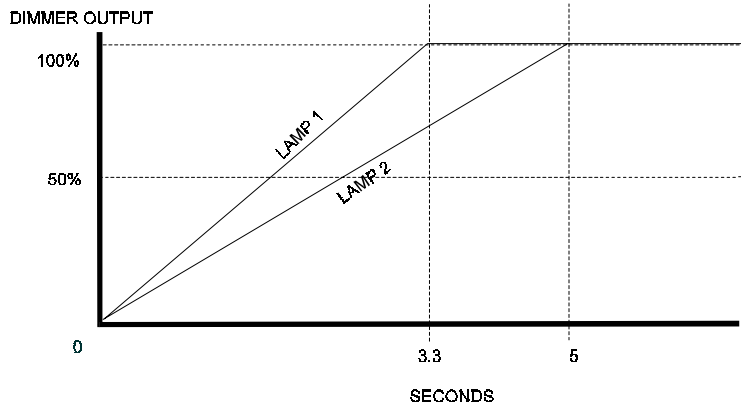

Default Patch

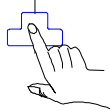

The SET-UP screen defaults for DIMMER and PATCH may be edited to suit your own requirements and once entered these become the new defaults.

The DEFAULT key under the LCD menu will return the screen to its original default values (1:1 all channels at 100%) following any editing.

A THRU list can be used to default part of the patch, for example:-

1 THRU 10 <DEFAULT> patches dimmers 1 to 10 to channels 1 to 10

Dimmer and Patch		Options
Dimmer Output	DMX512	← AMX 192, D54
AMX Scaling %	100	← 80 - 120%
D54 Scaling %	100	← 80 - 120%
Default Scale %	100	← 0 - 200%
Default Frame	10	← 2 - 40
Default N-Dim	80	← 0 - 100%

The 'Default Frame' setting applies to colour scroller frames, an option available in the **Kaleidoscope** software package. For more information on how to change all these values see 'Menu Editing' in the **Software Installation** chapter.

Live/Preview Patches

Two sets of Patch data are held by GSX, PATCH 1 and PATCH 2, either of these can be designated as a LIVE patch or a PREVIEW patch.

The LIVE patch when edited will have an immediate effect on the stage output, whilst editing the PREVIEW patch will not affect the stage output.

Having these two options gives you the opportunity, for instance, to set up two completely different patches to suit two different shows.

Press SET to gain access to the SET PATCH MENU.

Once in the SET PATCH MENU the following options become available:-

- ORDER - Toggle action, switches the screen display between **dimmer order** (default) and **channel order**. **Channel order** is useful if a wide range of dimmers is patched to one channel as they can all be seen on one screen. In **dimmer order** these would need to be scrolled through.
- LIVE - Toggle action, selects PATCH 1 or PATCH 2 to become the 'live' screen. The status is shown in the middle row of the LCD.
- EDIT - Toggle action, selects which PATCH screen is to be edited. The status is shown in the middle row of the LCD.

The side figures show LIVE=1 EDIT=1 which means that PATCH 1 when edited will have changes appear live on stage.

LIVE=1 EDIT =2 means that PATCH 2 becomes the preview patch and will be edited 'blind', the changes not appearing on stage.

Actions such as 'Live' and 'Default' take several seconds to complete. The command line display shows a flashing cursor until the action is complete.



```
PATCH MENU
LIVE : 1      EDIT : 1
DEFAULT SET  @NON
```



```
SET PATCH MENU
LIVE : 1      EDIT : 1
ORDER LIVE=  EDIT=
```



```
SET PATCH MENU
LIVE : 1      EDIT : 2
ORDER LIVE=  EDIT=
```

Editing Patches

All editing in the PATCH screen is done using the keypad regardless of whether the console is configured as DIRECT ENTRY or COMMAND LINE mode. All entries must be completed by the ENTER (*) command.

The wheel does not function in editing mode as in other screens and is used only to scroll the PATCH screen pages.

Patching Dimmers

The first figure entered when editing on this screen is always the dimmer number and because of this the @ key functions differently than when used with other screens.

1 @PATCH 10 < * >

Assigns dimmer 1 to channel 10 at the default scaling level.

2 @PATCH 10 @PATCH 70 < * >

Assigns dimmer 2 to channel 10 at a scaling of 70%, (see **Scaling** section).

3 THRU 6 @PATCH 11 < * >

Assigns dimmers 3, 4, 5, and 6 to channel 11 at the default scaling level, (see page 80).

Patching Non dims

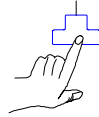

Lights can be switched to **Non-dim** which means that they will switch on and off at a threshold level. This is useful for controlling effects motors.

There is no key on the console for entering channels as Non-dims but on the PATCH menu there is an @NON setting which acts as a command key.

13 @NON 13 < * >

Assigns dimmer 13 to channel 13 as a Non-dim at the default ON/OFF threshold.

14 @NON 14 @NON 50 < *.>

Assigns dimmer 14 to channel 14 as a Non-dim with an ON/OFF threshold of 50%.

15 THRU 18 @NON 15 < * >

Assigns dimmers 15, 16, 17, and 18 to channel 15 as Non-dims with the default On/Off threshold.

Unpatching

Any dimmer patched to Channel 0 becomes unpatched or alternatively a dimmer can be unpatched as shown in the example below.

7 THRU 9 @PATCH < * > : will unpatch dimmers 7 to 9.

Any dimmer that is already patched and gets re-patched to a new channel will be automatically de-patched from the old channel.

Unpatched dimmers appear as blank in the PATCH screen and cannot be controlled.

Example Patch Screen

The commands used in this chapter can be viewed on the example screen shown in the figure below.

PATCHED DIMMERS

UNPATCHED DIMMERS

09:00:00 01 / 08 / 93		PATCH 1 LIVE						195 Free cues			GM = FL		
DIM	1	2	3	4	5	6	7	8	9	10	11	12	
CHN	10	10	11	11	11	11				12	13	14	
	100%	70%	100%	100%	100%	100%				100%	100%	100%	
DIM	13	14	15	16	17	18	19	20	21	22	23	24	
CHN	13	14	15	15	15	15	19	20	21	22	23	24	
	80N	50N	80N	80N	80N	80N	100%	100%	100%	100%	100%	100%	
DIM	25	26	27	28	29	30	31	32	33	34	35	36	
CHN	25	26	27	27	27	37	31	32	33	34	35	36	
	100%	100%	100%	100%	100%	100%	100%	100%	100%	100%	100%	100%	

PATCHED NON-DIMS
80 = THRESHOLD LEVEL N = NON DIM

Basic Effects

Genius will allow **Chase** effects to be recorded and played back, whereby each step is recorded and played back in sequence, one step at a time. The full range of effects with up to 30 memories are available with the **Kaleidoscope** package.

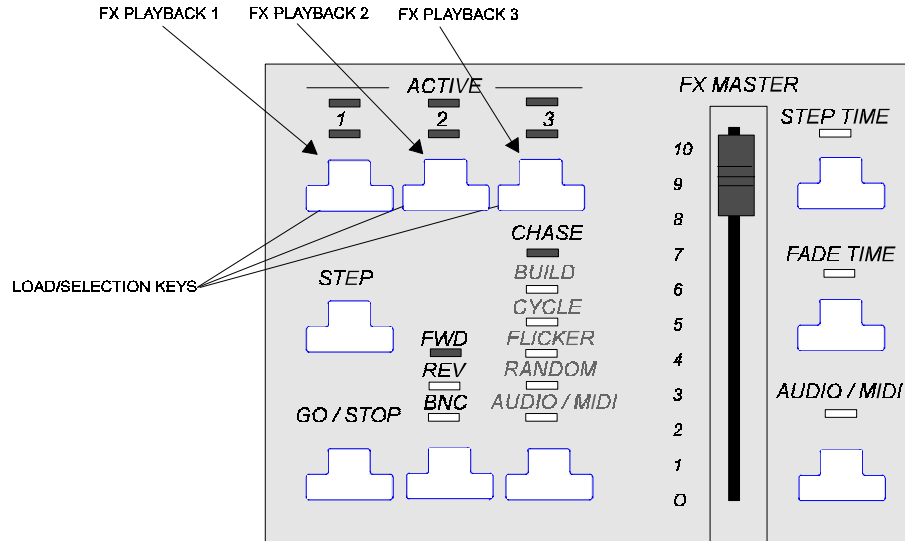

Up to 3 effect memories may be stored in a Genius, any of which may be active at any one time and run simultaneously.

Recording Effects

Setting up and recording effects are carried out in the EFFECTS PREVIEW screen.

Access to this screen is shown in the figure overleaf.

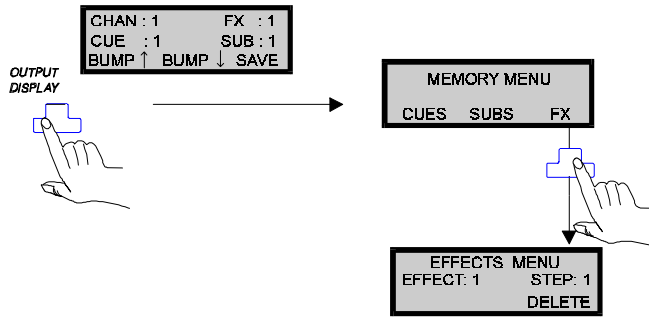

09:00:00 01 / 08 / 93		EFFECTS PREVIEW										200 Free cues		GM = FL										
001	02	03	04	05	06	07	08	09	10	11	12	13	14	15	16	17	18	19	20	21	22	23	24	025
026	27	28	29	30	31	32	33	34	35	36	37	38	39	40	41	42	43	44	45	46	47	48	49	050
051	52	53	54	55	56	57	58	59	60	61	62	63	64	65	66	67	68	69	70	71	72	73	74	075
076	77	78	79	80	81	82	83	84	85	86	87	88	89	90	91	92	93	94	95	96	97	98	99	100
101	02	03	04	05	06	07	08	09	10	11	12	13	14	15	16	17	18	19	20	21	22	23	24	125
Effects Sheet												Wheel												
FX Step	Type	Dir	Fade T	Step T																				
1.1	CHASE	FWD	5/5	0.1																				
Submasters												A/B Playback				Effects								
01	02	03	04	05	06	07	08	09	10	11	12	A		B		1	2	3						
13	14	15	16	17	18	19	20	21	22	23	24	In / Out												
Cue																								
EFFECT PREVIEW :*																								
Select an effect memory, then edit an item or set steps																								

Effects are recorded in a similar manner to cues and are entered as a series of steps. Each effect can have up to 48 steps and in the default screen, above, Effect 1 Step 1 (1.1) is always recorded and ready to accept channel entries. The highlight box must be over the FX STEP field before recording.

1 ON* Enters Channel 1 into step 1, levels are always at Full in this screen.

Recording extra steps are performed as shown in the example below, only the step number is needed.

FX . 2 RECORD*
*RECORD FX . 2 < * >* Records step 2 of effect number 1 (entering FX 1. 2 is not necessary).

The RECORD function in this screen copies the previous cue hence the COPY command displayed.

- 1 @ 0 Puts channel 1 at zero
- 2 ON * Enters channel 2 in this step

Effects Sheet

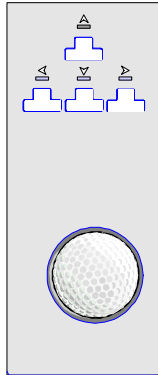

The Effects Sheet shows all effect memories and their options. The directional cursor keys move the highlight box around and the wheel or keypad change the settings.

If the setting is changed for one of the steps, i.e. FWD is changed to REV in step 1.1, as soon as the highlight box moves to another field **all steps in FX 1** will update to that setting, FX2 and FX3 remain unchanged.

- Type :** CHASE only (other effects require **Kaleidoscope**).
- Direction :** Forward, Reverse or Bounce
- Fade time :** Time taken for the WHOLE effect to fade in and out.
- Step time :** Time it stays at each step.

Example Effects

An example of how to set up an 8 step chase effect is shown in the **Quickstart Tutorial** chapter, refer to this for further information.

The final screen representation for that chase is shown underneath.

09:00:00 01 / 08 / 93												EFFECTS PREVIEW												200 Free cues			GM = FL			
001	02	03	04	05	06	07	08	09	10	11	12	13	14	15	16	17	18	19	20	21	22	23	24	025						
FL																														
026	27	28	29	30	31	32	33	34	35	36	37	38	39	40	41	42	43	44	45	46	47	48	49	050						
051	52	53	54	55	56	57	58	59	60	61	62	63	64	65	66	67	68	69	70	71	72	73	74	075						
076	77	78	79	80	81	82	83	84	85	86	87	88	89	90	91	92	93	94	95	96	97	98	99	100						
101	02	03	04	05	06	07	08	09	10	11	12	13	14	15	16	17	18	19	20	21	22	23	24	125						
Effects Sheet																							Wheel							
FX Step	Type	Dir	Fade T	Step T																										
1.1	CHASE	FWD	5/5	0.5																										
1.2	CHASE	FWD	5/5	0.5																										
1.3	CHASE	FWD	5/5	0.5																										
1.4	CHASE	FWD	5/5	0.5																										
1.5	CHASE	FWD	5/5	0.5																										
1.6	CHASE	FWD	5/5	0.5																										
1.7	CHASE	FWD	5/5	0.5																										
1.8	CHASE	FWD	5/5	0.5																										
Submasters												A/B Playback						Effects												
01	02	03	04	05	06	07	08	09	10	11	12	A		B				1		2		3								
13	14	15	16	17	18	19	20	21	22	23	24	In / Out		Cue																

EFFECT PREVIEW :*

Select an effect memory, then edit an item or set steps

Load/Run Effects

Up to three effects can be loaded at the same time and run together. These effects are assigned to three 'Effect Playbacks' by the toggle action Load/Selection keys.

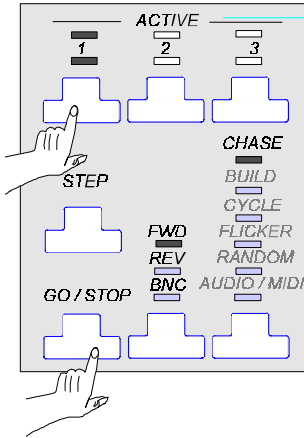

- To load and automatically select an effect, press key 1, 2 or 3. Both LEDs will be on and indicate that the effect highlighted on the FX screen is ready to run.
- To de-select the effect, press the key a second time. The effect still remains loaded (red LED on).

To start the effect(s) running, ensure the effect playback is selected and press the GO/STOP key.

The LED combinations in the figure below show the status of one of the Playbacks and its associated effect.

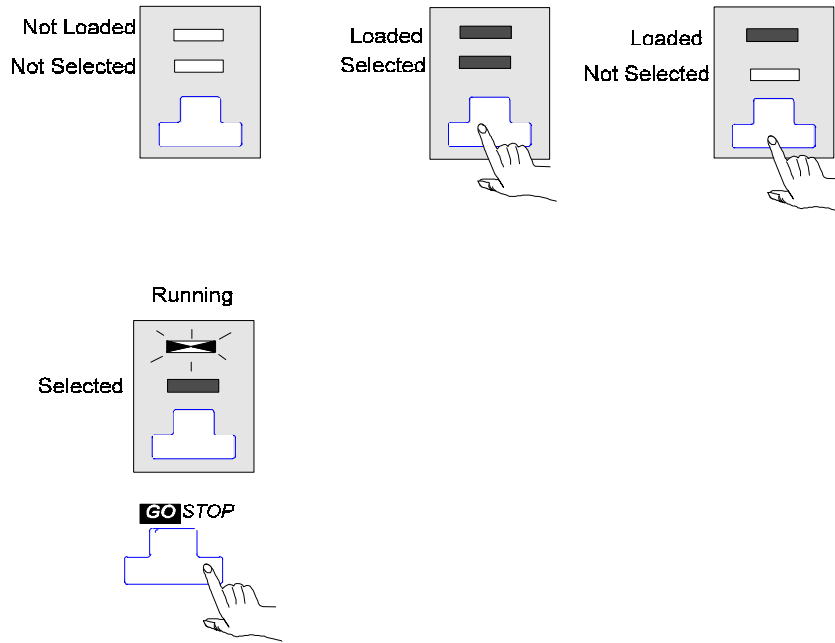
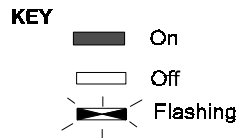

- You can record Effects in the OUTPUT screen, but remember the channel levels are irrelevant.
- It is also not necessary to be in the EFFECTS PREVIEW screen in order to call up, run or modify effects.
- If more than one effect is selected then all keys on the EFFECTS Playback are inhibited and all LEDs are off except the GO / STOP key. This is because each selected effect could have different TIMES and DIRECTIONS assigned to them.
- When one effect is selected, it can be manually stepped or adjusted using any of the EFFECT playback controls.
- Each effects LEDs flash in sync with its STEP TIME when running or fading up/down.
- A running effect can be de-selected without having to stop it first.

Start / Stop Effects

The GO/STOP key always starts or stops the currently selected effect(s).



If no effect is selected, the key has no function. When an effect is started or stopped the current effect fade time is used to fade the effect in or out.

Changing Running Effects

When one of the running effects is selected, changes can be made 'on the fly' by using any of the control keys mentioned below.

Direction

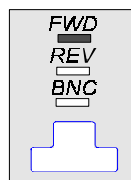

An effect can be driven in one of three directions and is selectable by using the key to toggle between them.

- **Forwards (FWD)** starts with the first step selected and ends with the last step and then repeats.
- **Reverse (REV)** starts with the last step selected and ends with the first step and then repeats.
- **Bounce (BNC)** starts with the first step, ends with the last step, then reverses.

Fade Time / Step Time

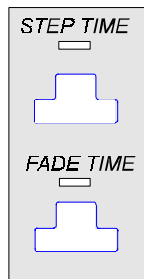

The FADE TIME or STEP TIME can be modified as follows:-

Hold down the appropriate key and move the wheel.

When the key is held down the current value is displayed in the Effects Playback window.

Moving the wheel will adjust the level.

Step

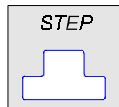

With the effect running, the STEP key overrides the automatic stepping and allows you to manually step through the currently selected effect.

If the automatic sequence is particularly fast, then you may not see all steps on the display.

Updating Effects

A running effect that has been modified 'on the fly' can be updated permanently when in the OUTPUT screen, as follows:-

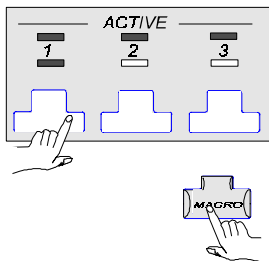

Press **MACRO** on the keypad and then the appropriate Playback select key.

This will overwrite your existing effect memory.

UPDATE FX appears on the VDU command line and if you return to the EFFECTS PREVIEW screen you will see that all the changes will have been recorded.

If you are unsure of which Playback is running the effect but you know, for example, the effect you want to change is FX 8 then key in:-

MACRO FX 8 RECORD *
*RECORD MACRO FX 8 < * >*

Deleting Effects

The DELETE key erases the highlighted step or alternatively:-

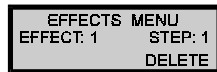

FX 1.1 DELETE *

Deletes step 1 of FX 1

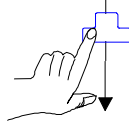

FX 1.1 THRU 2 . 9 DELETE *

Deletes all steps from FX1.1 to FX 2 . 9

FX Master

The FX MASTER fader will master the output levels of **all channels in running effects.**

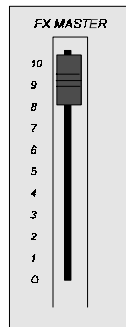

Tips for setting up Chase Effects

As the RECORD function copies the previous cue when in the EFFECTS PREVIEW screen, you may find it easier to set up a series of 'blank' steps for chases.

Notes:-

Macros

The purpose of a macro is to execute a regularly used command or even a string of commands using the minimum of keys. The MACRO key is used in conjunction with various other keys to execute certain commands. Genius has the following macro facilities.

- 17 Built-in Macros
- 10 User configurable Macros (0-9)

Built - in Macros

A lot of the Built-in macros and how to access them have been covered in previous chapters; but as a reminder, to execute them the MACRO key must be pressed before the appropriate key. Built-in macro keys are identified in blue text on the console.

A table of the built-in macros is shown below.

KEYPRESSES	FUNCTION
MACRO ON	On at full
MACRO CLR	Clears Command Line
MACRO LAST	Recalls Last Command
MACRO DISPLAY	Go To OUTPUT Display
MACRO -	Remainder Dim
MACRO +	Solo (Toggle)
MACRO THRU	Selects Channels Above Zero
MACRO @	Undo Last @
MACRO @COL	Undo Last @COL
MACRO REC	Undo Last REC
MACRO REC-TIME	Undo Last REC-TIME
MACRO CUE	Updates Cue Channels
MACRO LOAD A	Updates A Playback Channels
MACRO LOAD B	Updates B Playback Channels
MACRO LOAD X	Updates X Playback Channels
MACRO SUB	Updates Submasters Channels
MACRO FX	Updates running Effect

The figure below highlights the location of all Macro keys, most being situated in the keypad area with three more on the Playback areas.

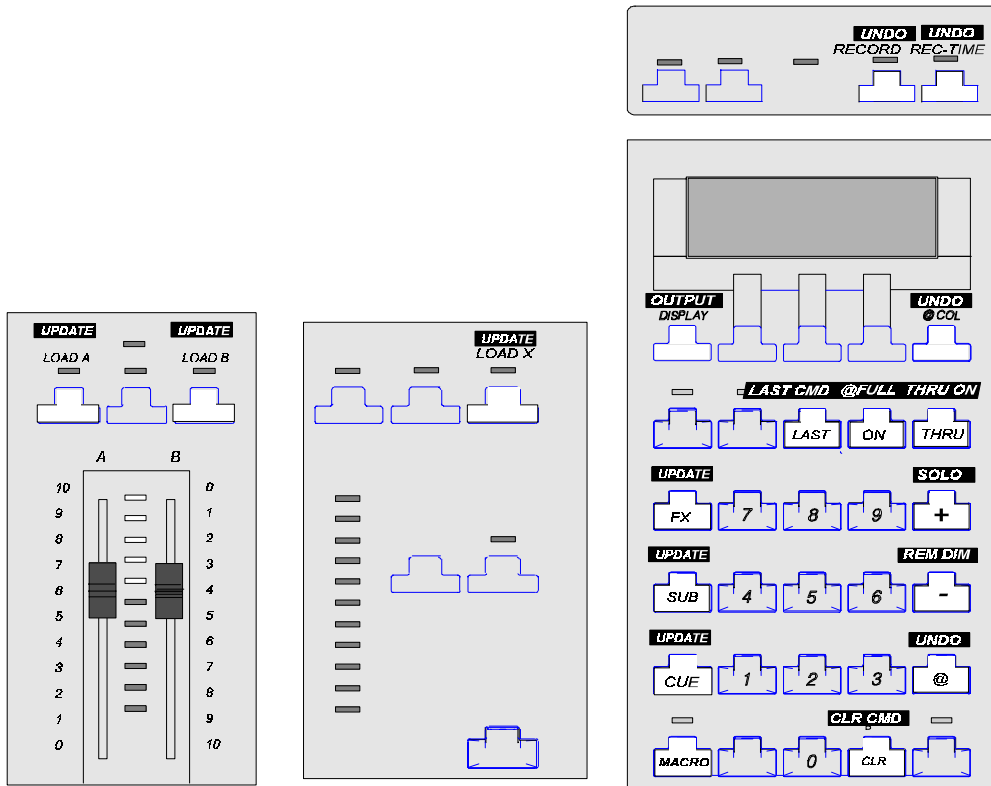

Recording User Macros

The numeric keys 0 - 9 on the keypad can be used in conjunction with the MACRO key to store your own macros.

What is actually stored is a sequence of up to 32 key strokes.

The User Macro facility is a very useful tool and offers a means of customising the console to suit your own needs. Quick editing facilities also mean that the Macros can be changed simply and effectively.

User Macros are recorded in the MACRO screen, accessible via the route shown below.

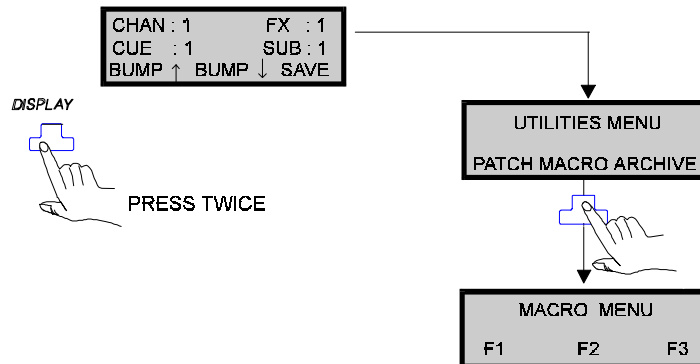

Macros		Wheel
0:		
1:		
2:		
3:		
4:		
5:		
6:		
7:		
8:		
9:		

Submasters		A/B Playback		Effects		
01	02	03	04	A	B	1
05	06	07	08	In / Out		2
09	10	11	12	Cue		3
13	14	15	16			
17	18	19	20			
21	22	23	24			

MACRO: Press MACRO <0-9> to start and end editing

Let's set up some example User Macros.

Example Macros

Example Macro 0: A general channel check is required to see if any lamps are not working before a production commences, record this as CUE 200.

1. Return to OUTPUT screen.
2. Key in **1 THRU 125 <Wheel to 30% >**
3. Key in **CUE 200 TIME 10 RECORD ***
RECORD 200 TIME 10 <>*
4. Go to the MACROS screen.
5. Press **MACRO 0** Starts recording Macro 0.
6. Key in **CUE 200 GO** Puts cue 200 on stage.
7. Press **MACRO 0** Completes recording of Macro.

Now anytime you are in the OUTPUT screen you can run up this macro by keying in MACRO 0.

All macro setting up and editing must be done in this screen. Editing is simply a matter of removing commands from the Macros window with the CLEAR key and re-entering.

Example Macro 1: You can set a macro up to 'shortcut' the route to frequently used screens such as the SET PATCH Menu. This is slightly more complex as all setting up must be done in the MACROS screen. This should be approached as follows:-

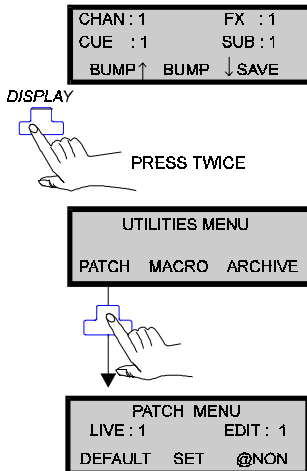

Refer to the MENU / SCREEN FLOW CHART in **Appendix A** to remind you of the menu routings.

DISPLAY must be pressed twice to get to the UTILITIES MENU.

The F1 key then selects the PATCH screen.

Note these actions and refer to the procedure overleaf.

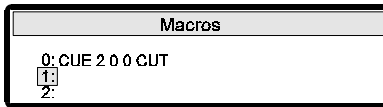
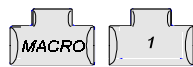

1. Press MACRO 1, to start recording.

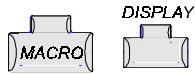

2. Press MACRO DISPLAY, this ensures the macro starts at default screen.

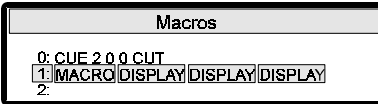
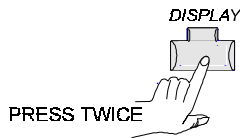

3. Press DISPLAY key twice (UTILITIES menu).

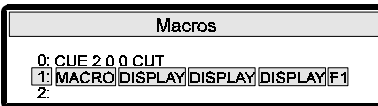
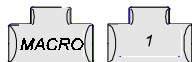
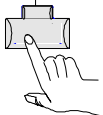

4. Press F1 (PATCH screen).

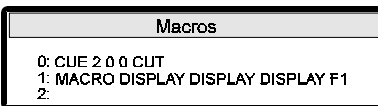

5. Press MACRO 1 again.

The Macro is now recorded. To verify this, go to another screen and press MACRO 1 again; the screen changes to the SET PATCH menu immediately.

Repeat this procedure to set up Macros for other screens you may use often.

F1, F2, F3 on the MACROS menu have no other function other than to be included as part of a macro set up.

Triggering User Macros

User defined Macros can be set up to be triggered automatically in a number of ways:-

Power Up Macro - This is entered in the SET-UP screen by changing the OFF setting to the required macro number. The macro runs whenever the unit is switched on or after a power fail situation.

Submaster Macro - Raising the selected submaster above the zero level will trigger the entered Macro. (see 'Triggering Macros' in the **Submasters** chapter for exact procedure).

The COMMUNIQUÉ software package also offers other ways to trigger macros by means of the following options:-

- **Audio**
- **Midi**
- **RS232**

A blank User Macro table is located in the back of the manual for your use.

Archive Screen

The ARCHIVE screen allows you to do the following:-

- Copy a show (or part of a show) from disk.
- Load new software.
- Format new disks.
- Obtain printouts.
- Clear down existing memories.

Access the screen as shown below.

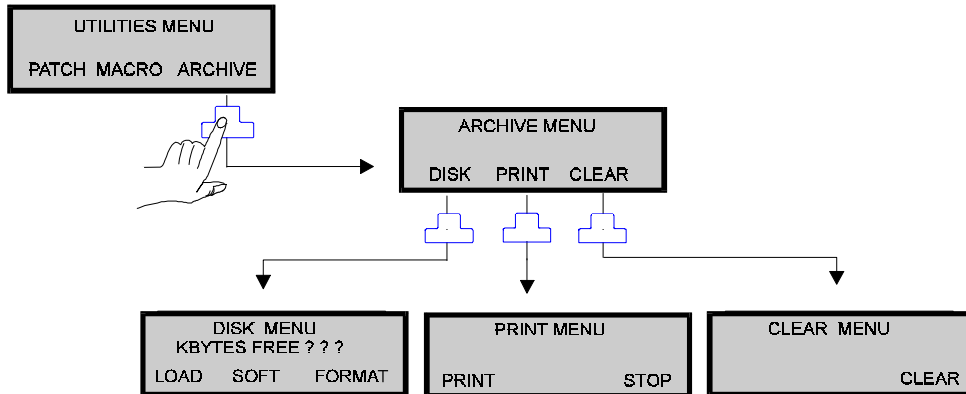

09:00:00 01 / 08 / 93 **ARCHIVE** 165 Free cues GM = FL

001 02 03 04 05 06 07 08 09 10 11 12 13 14 15 16 17 18 19 20 21 22 23 24 025

026 27 28 29 30 31 32 33 34 35 36 37 38 39 40 41 42 43 44 45 46 47 48 49 050

051 52 53 54 55 56 57 58 59 60 61 62 63 64 65 66 67 68 69 70 71 72 73 74 075

50 50 80 80 80 80 75 30

076 77 78 79 80 81 82 83 84 85 86 87 88 89 90 91 92 93 94 95 96 97 98 99 100

Archive Selection		FIRST	LAST	Wheel		
<input checked="" type="checkbox"/>	SELECT					
	Patch					
	Cue & FX Sheet					
WHOLE SHOW ■	Cues	1	999			
	Submasters	1	24			
	Effects	1	30			
	Setup & Macros					
	Error Log (PRINT & CLEAR only)					
Submasters		A/B	Playback	Effects		
01 02 03 04 05 06 07 08 09 10 11 12		A:	B:	1	2	3
13 14 15 16 17 18 19 20 21 22 23 24	In / Out Cue					

ARCHIVE DISPLAY *

Select memory group(s) using + and - keys

Clear Menu

The Archive Selection area allows you to select which category and its associated memories you require to clear.

1. Move the highlight box with the cursor buttons to the SELECT area and press the + key, a tick will appear (- key removes it).

Archive Selection			
	SELECT	FIRST	LAST
WHOLE SHOW	✓ SELECT		
	Patch		
	Cue & FX Sheet		
	✓ Cues	1	999
	Submasters	1	24
	Effects	1	30
	Setup & Macros Error Log (PRINT & CLEAR only)		

2. Move to the FIRST field and <wheel> the first memory number to be cleared. Move to the LAST field and <wheel> the last number to be cleared.

Archive Selection			
	SELECT	FIRST	LAST
WHOLE SHOW	✓ SELECT		
	Patch		
	Cue & FX Sheet		
	✓ Cues	1	10
	Submasters	1	24
	Effects	1	30
	Setup & Macros Error Log (PRINT & CLEAR only)		

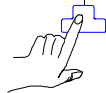

Press CLEAR

Cues, Submasters and Effects can all be individually cleared in this way or alternatively they can be jointly selected and cleared as well.

Beware when clearing Patch, Setup & Macros and the WHOLE SHOW as this will return the system to its default values.

*The CLEAR function is inhibited if the **Memory Lock** feature is on (note the screen title display).*

Print Menu

The Archive Selection area allows you to select which category and its associated memories you require to print.

1. Move the highlight box with the cursor buttons to the SELECT area and press the + key accordingly, repeat for other categories. Ticks will appear (- key removes them).

Archive Selection			
	SELECT	FIRST	LAST
WHOLE SHOW	✓ SELECT		
	Patch		
	Cue & FX Sheet		
	✓ Cues	1	999
	✓ Submasters	1	24
	Effects	1	30
Setup & Macros			
Error Log (PRINT & CLEAR only)			

2. Move to the FIRST field and <wheel> the first memory number to be printed. Move to the LAST field and <wheel> the last number to be printed.

Archive Selection			
	SELECT	FIRST	LAST
WHOLE SHOW	✓ SELECT		
	Patch		
	Cue & FX Sheet		
	✓ Cues	1	10
	✓ Submasters	1	24
	Effects	1	30
Setup & Macros			
Error Log (PRINT & CLEAR only)			



3. Press PRINT

All categories can all be individually or jointly printed.

Disk Menu

The disk menu has three options:-

- **LOAD** - For loading in a previously saved show or selected parts of it.
- **SOFT**- This is for loading in new APPLICATION or OPERATING SYSTEM software and is covered in detail in the **Software Installation** chapter.
- **FORMAT** - For formatting backup disks.

Loading Saved Shows

Pressing DISK automatically selects WHOLE SHOW as this is the most common category to load in. LOAD will then download it into the console.

Archive Selection			
	✓ SELECT	FIRST	LAST
	Patch		
	Cue & FX Sheet		
WHOLE SHOW ✓	Cues	1	999
	Submasters	1	24
	Effects	1	30
	Setup & Macros		
	Error Log (PRINT & CLEAR only)		

DISK MENU
KBYTES FREE ???
LOAD SOFT FORMAT

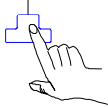

To Selectively load:-

1. Move the highlight box with the cursor buttons to the SELECT area(s) and press the + key accordingly. Ticks will appear (- key removes them).
2. Move to the FIRST field and <wheel> the first memory number to be loaded. Move to the LAST field and <wheel> the last number to be loaded.

Archive Selection			
	✓ SELECT	FIRST	LAST
	Patch		
	Cue & FX Sheet		
WHOLE SHOW	✓ Cues	1	10
	Submasters	1	24
	Effects	1	30
	Setup & Macros		
	Error Log (PRINT & CLEAR only)		

3. Press LOAD

Formatting Disks



Formatting a disk will erase any data previously recorded on it unless the disk is write protected (tab open), in which case formatting cannot take place.

Format works with **Memory Lock** on or off but will not work if the disk is write protected (tab open).

To format a new disk:-

1. Ensure the write protect tab on the disk covers the hole (write protection disabled).
2. Insert disk into the disk drive (label up).
3. Follow the formatting procedure shown below :-

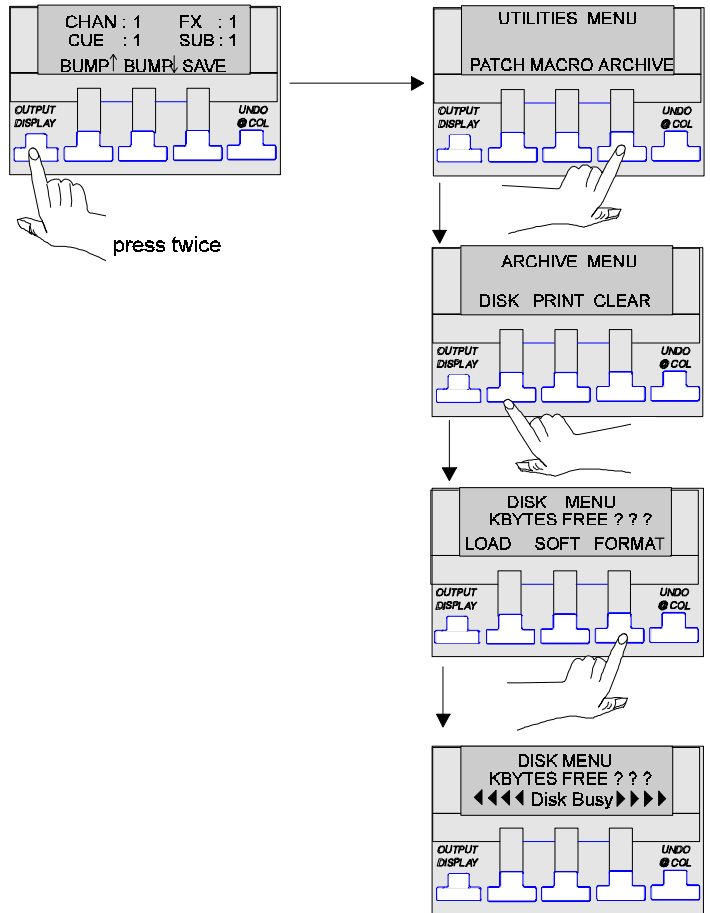

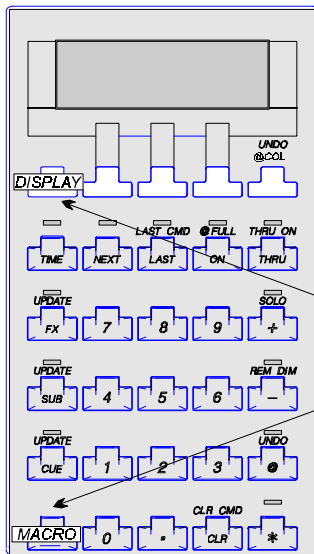

When formatting is complete press MACRO and then DISPLAY to return to the OUTPUT screen.

OPERATING and APPLICATION software can be copied on a standard IBM compatible P.C. and it is advisable to back these up as early as possible.

LBX

LBX offers all the facilities of GSX plus the following additional features:-

- Additional fader banks for 1 or 2 scene presets.
- Additional Masters panel (C/D)
- Integral Power Supply
- Four Modes of Operation

The differences between GSX and LBX are highlighted below:-

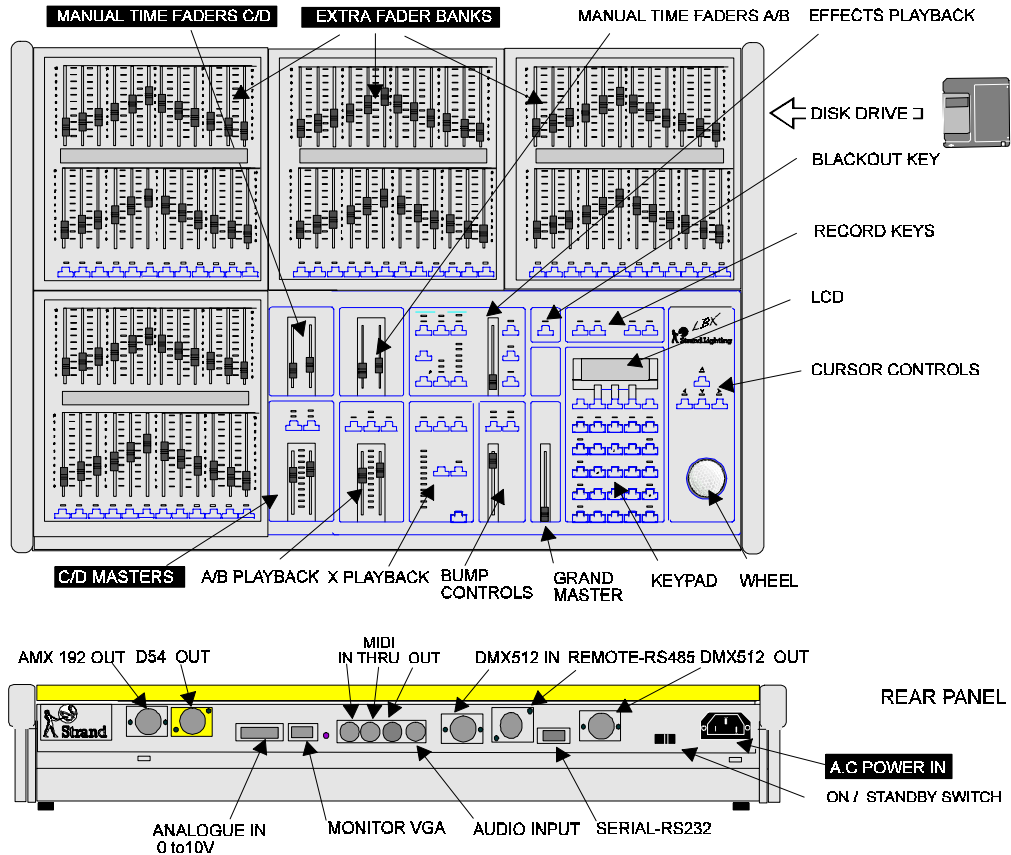

Warning
LBX contains mains voltages, do not remove any covers or panels without switching off first and ensure that the unit is properly earthed before use.

The extra fader banks and Masters panel plus four different ways of operating offers a great deal of flexibility and as such LBX can be set up to work as a conventional single or two scene preset lighting desk with or without a Submaster bank.

Direct access of up to 96 channels is possible if Genius 100 or 125 is installed. All Genius software supports both GSX and LBX consoles.

All Channels under fader control are shown as white on black on the VDU similar to the A/B Playback.

Operational Modes

These modes are selectable through the **Setup** screen. Once in this screen move to the LBX MODE field with the cursor keys and the options can be scrolled through either with the + and - keys or the wheel.

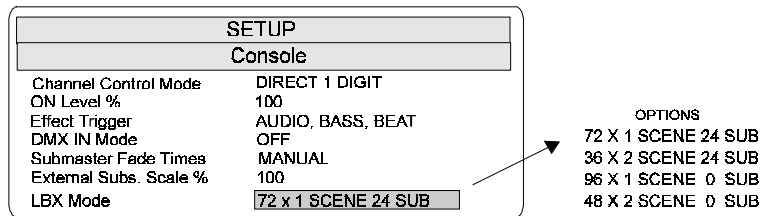

The 36 x 2 and 48 x 2 scene presets offer a conventional 2 scene set up either with or without a Submaster function.

The 72 x 1 and 96 x 1 single scene presets offer a larger channel capacity using the Auto Hold feature to set up a 'Blind' scene as in a normal 2 scene preset desk. Once again this can be utilised with or without a Submaster function. Channel faders always correspond numerically to the first 36, 48, 72 or 96 channels of the LBX system.

Changing operating modes during a show is not recommended as channel levels may become unpredictable!

72 x 1 Scene Preset 24 Subs (Default Mode)

All faders in the top three banks, shown overleaf, are assigned as **channels** and are mastered by Preset C in the C/D Masters panel. Control is manual if Preset C fade time is set to zero or alternatively a time setting takes precedence.

The 24 faders in the bottom bank are assigned as **Submasters**. These faders will output and control the Submaster on a HTP level with the fader.

The colour of the channel levels shown on the VDU indicate which option has control of these channels.

WHITE Fader or A/B Playback control
 YELLOW Submaster Control

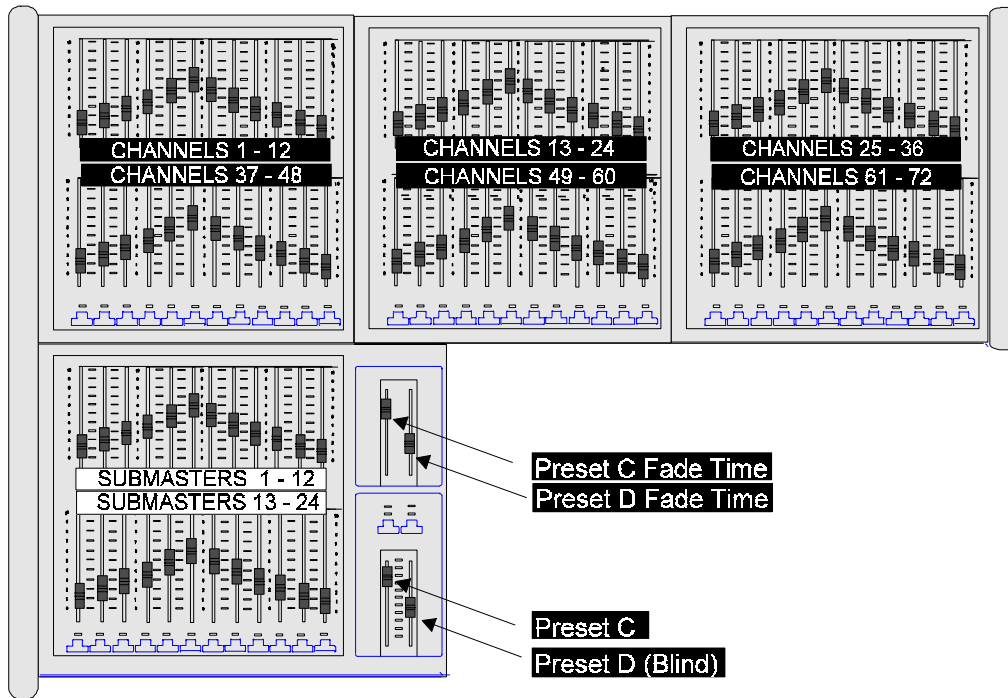

Auto Hold

C/D FADE TIMES

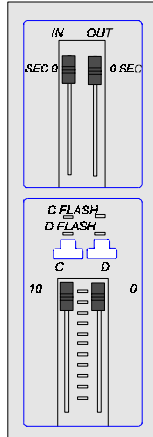

C/D PRESET MASTERS

In a normal 2 scene preset desk there are two sets of faders, one usually controls the Live, or on stage scene, whilst the other is for setting up a Blind, or off stage scene. A Crossfade takes place when the preset master faders for these rows are moved together.

Although there may, for example, be a total of 72 faders across these two rows, it is in effect only a 36 channel x 2 preset desk.

Using LBX's Auto Hold feature, 72 channels can be assigned to a single scene with the added bonus of a second preset and Submaster facility. In fact a maximum of 96 channels per scene can be used if Submasters are not required.

A blind scene is set up as the following example shows:-

1. Make sure the C/D Preset master faders are completely in the home position (top) as shown in the side figure.

For the purposes of this example the C/D fade times are set to zero in order to see an instantaneous response when crossfading, however in practise they can be set to any value.

- Set channels 1 to 72 at FULL by using the appropriate faders to make the scene live on stage.

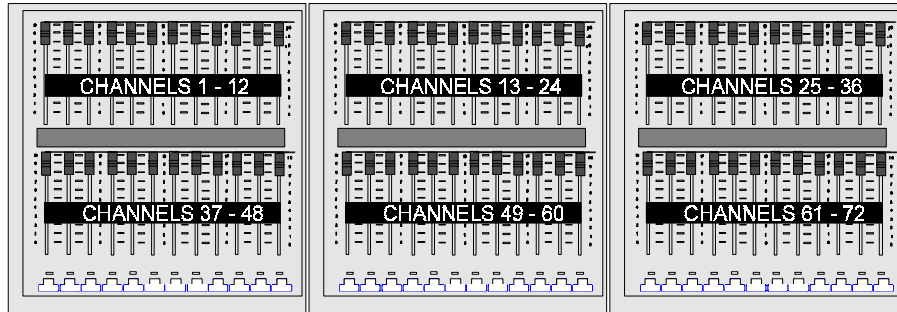

- Move C/D Preset Masters together to the bottom position. The scene on stage remains unaffected.

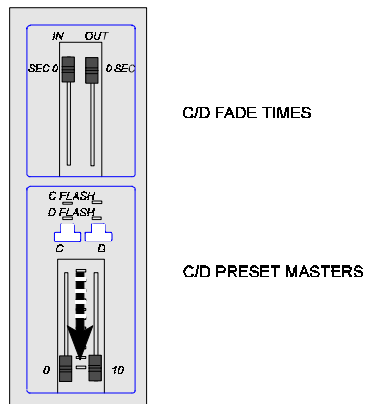

- Set channels 1-12 to 50%, the scene on stage still does not change.

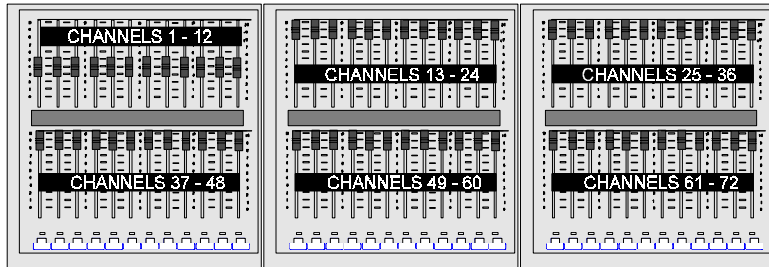

- Move C/D Preset Masters back up to the top position. This Crossfades between the Blind scene and the Live scene on the C faders.

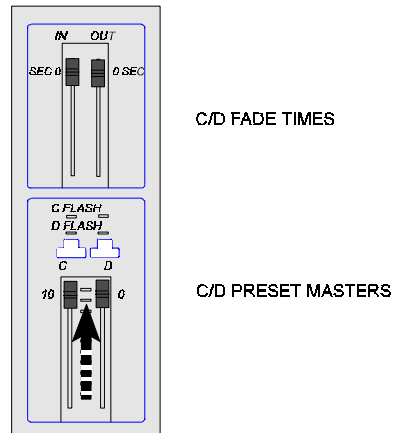

Channels 1 - 12 are now at 50% on stage whilst all other channels remain at their original settings.

The Auto Hold feature is useful for changing scenes 'on the fly' as levels can be altered and lights added or removed with minimal distraction on stage.

36 x 2 Scene Preset 24 Subs

The top row of faders are assigned as **channels 1 - 36** mastered by Preset C. The bottom row of faders are assigned as **channels 1 - 36** mastered by Preset D.

A dipless Crossfade is achieved by moving both C/D Preset master faders together.

Submasters are assigned to both sets of faders in the lower tier. These will output and control the Submaster on a HTP level with the channel faders. The colour of the figure levels shown on the VDU indicate which option has control of these channels.

- WHITE for channel fader or A/B Playback
- YELLOW for Submaster

SETUP	
Console	
Channel Control Mode	DIRECT 1 DIGIT
ON Level %	100
Effect Trigger	AUDIO, BASS, BEAT
DMX IN Mode	OFF
Submaster Fade times	MANUAL
External Subs. Scale %	100
LBX Mode	36 x 2 SCENE 24 SUB

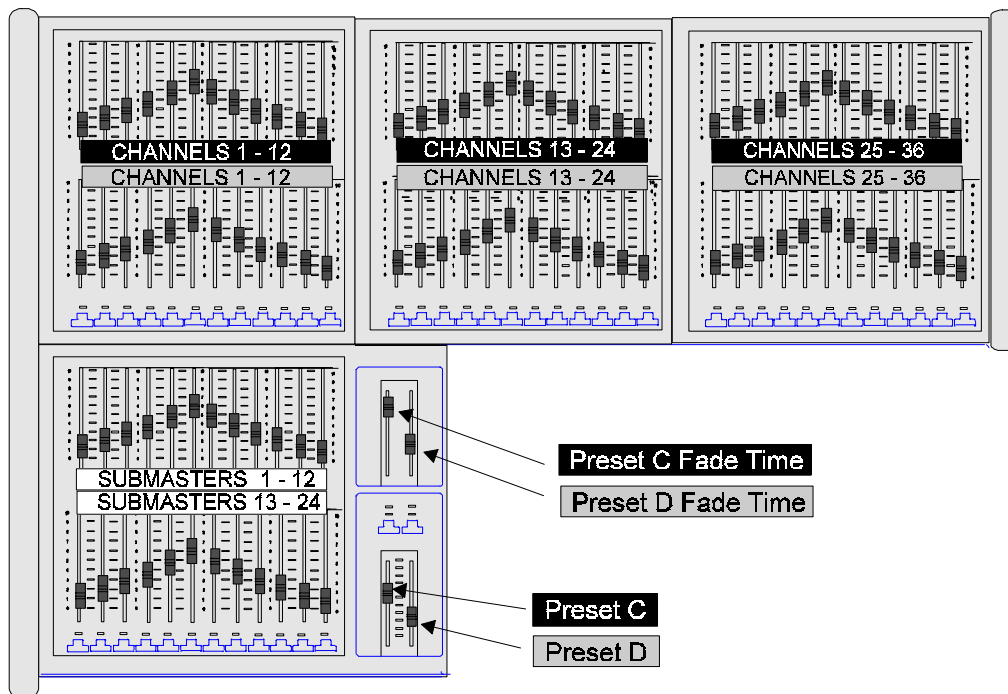

96 x 1 Scene Preset 0 Subs

All faders are assigned as **channels** and are mastered by Preset C in the C/D Masters panel.

No Submaster faders are assigned, but external Submasters will function if **Communiqué** software is installed.

SETUP	
Console	
Channel Control Mode	DIRECT 1 DIGIT
ON Level %	100
Effect Trigger	AUDIO, BASS, BEAT
DMX IN Mode	OFF
Submaster Fade times	MANUAL
External Subs. Scale %	100
LBX Mode	96 x 1 SCENE PRESET 0 SUB

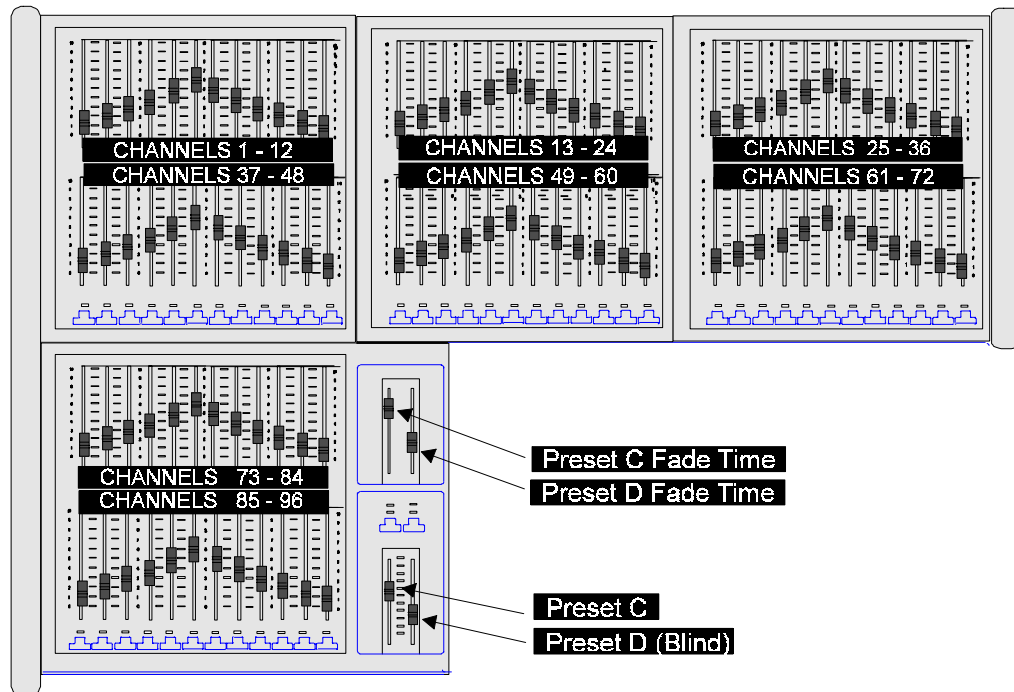

This mode operates in a similar manner to the 72 x 1 scene mode but offers a maximum channel capacity of 96 instead of 72 with no Submaster facility.

Blind scene facilities are also available in this mode by using the Auto Hold feature as described earlier in this chapter.

48 X 2 Scene Preset 0 Subs

All top row faders are assigned as **channels 1- 48** mastered by Preset C. All bottom row faders are assigned as **channels 1 - 48** mastered by Preset D.

A dipless Crossfade is achieved by moving both C/D Preset Master faders together.

No Submaster faders are assigned, but external Submasters will function if **Communiqué** software is installed.

SETUP	
Console	
Channel Control Mode	DIRECT 1 DIGIT
ON Level %	100
Effect Trigger	AUDIO, BASS, BEAT
DMX IN Mode	OFF
Submaster Fade times	MANUAL
External Subs. Scale %	100
LBX Mode	48 x 2 SCENE PRESET 0 SUB

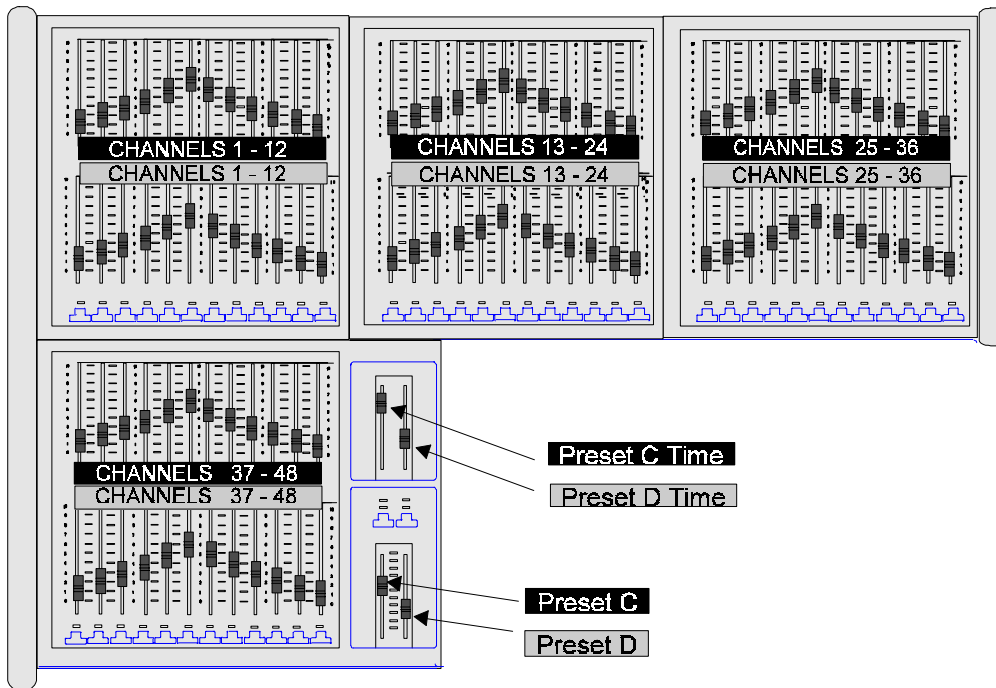

Suitably numbered decals are supplied with LBX for your convenience. Once the required mode of operation has been set, the appropriate decals should be removed from their backing sheets and carefully fitted in the slots on the fader banks.

Please retain the original decals, they can be re-used.

Zero Pick up Point

In order for a fader to gain or regain control of a channel, **it must be set to the Zero position.** Only when in the zero position will the fader 'pick up' the channel and gain control of it.

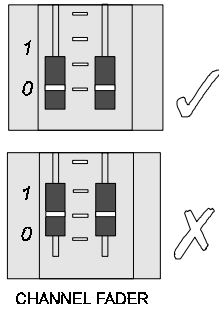

When levels are controlled from the Channel Control they cannot be 'picked up' again by a fader until it is returned to the zero position. Always check this after clearing down channel levels using the Channel Control (keypad input).

C/D FadeTimes

The C/D Master faders are under manual control when both time faders are in the top position. When the time faders are moved from this position the Preset Master faders work in conjunction with these times.

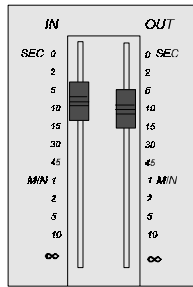

These faders are for controlling scene fade IN and fade OUT times and can be set up separately and work independently of each other.

C/D Flash Modes

In order for any flash mode to become active ensure the OFF LED on the Flash Control panel is not lit.

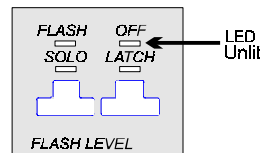

Pressing the SHIFT key (toggle action) makes either C Flash or D Flash active, this is indicated by the appropriate LED.

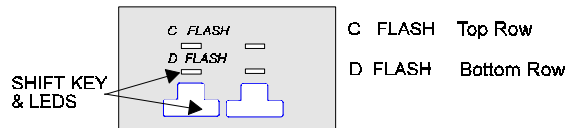

The BUMP keys below each fader flash up the channel to Full.

Using LBX Channels with Playbacks, Submasters and Channel Control

Faders and their respective channels operate independently but common channels i.e the same ones that are controlled by the fader and are loaded in the X Playback or active Submasters will always operate on a HTP basis.

The option that has control is indicated by the colour of the channel levels shown in the VDU.

Recording the output using the REC-SUB key will eliminate any contribution the manual faders make to the recorded cue.

When LBX channels are used with Playbacks and Submasters it is always the highest level that takes precedence.

- Channel 1 Submaster level 50%
- Channel 1 Playback level 60%
- Channel 1 Fader level 45%

If channel 1 levels were set as above, the Playback level would take precedence as it is the highest. Moving channel fader 1 would have no affect until the Playback level was exceeded and although the level can be increased it can never fall below the Playback level.

Using Channel Control will allow overriding control of the channel levels by means of 'stealing channels'. This means that the channel can be 'stolen' from its controlling factor, e.g. channel fader, by using Channel Control (keypad input) and become completely independent.

Stealing a Channel

In order to get a good understanding of how Channel stealing works, follow the example below:-

1. Return all faders to the zero position.
2. Clear screen: **CUE 0 GO**
3. Set channels 1 through to 10 at 50% using the faders.
4. Key in: **1 THRU 5 <wheel>**

Channels 1 to 5 are now under Channel Control indicated by the red boxed figures. You are now free to wheel the channels to **any** level. Alternatively you could type in new levels.

Errors / Faultfinding

Errors and faults fall into three groups.

- Electrical
- Mechanical
- Operational

Most 'faults' are likely to be operational and a result of keying in the wrong command. Mechanical faults are usually caused by badly or incorrectly connected peripherals.

A number of self tests are automatically performed on power up and during normal operation. Genius runs a series of self tests that check the following:-

- Memory is O.K.
- If any control keys are stuck.
- Software validation.
- Hardware (PCB connections etc.).

Error log

A log is kept in the system memory of all errors and anomalies found and can be displayed on the VDU.

Electrical problems are likely to be rare and these are outside the scope of this manual, however, the LOG screen may contain useful information to impart to your service agent.

To gain access to this screen follow the diagram overleaf.

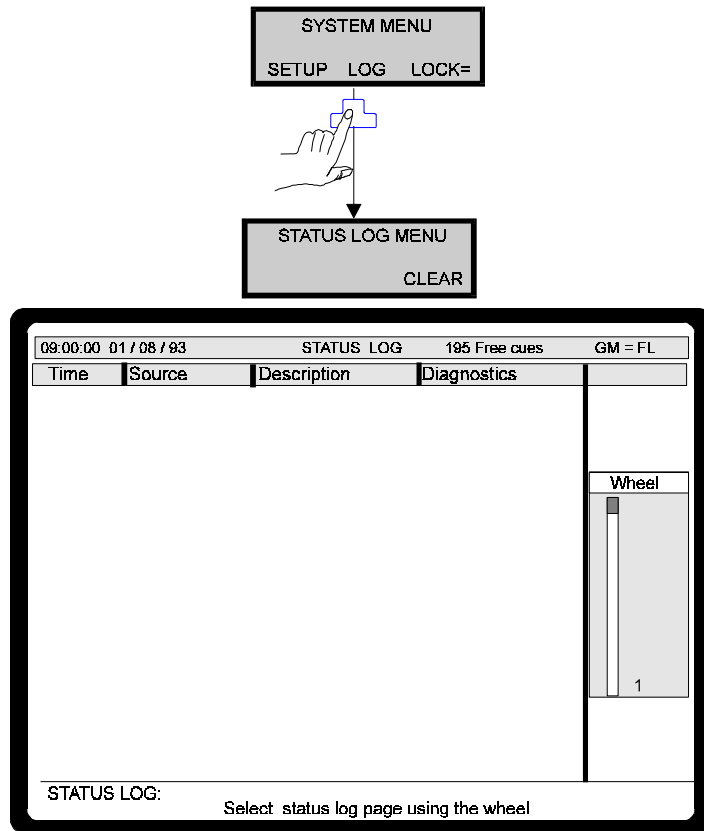

Faults on Power Up

If a fault occurs when switching on it will be reported in the LCD. The message displayed may tell you that a control key is stuck, in which case you may be able to correct it yourself, or it will refer to a technical problem.

Should one of these technical error messages appear, switch the console off and back on again to see if this corrects the problem or else press CONT and try to use the console again. If this fails try to reload your Operating Software disk (see **Software Installation** chapter).

If in doubt, or reloading is not successful, contact your dealer or Strand Lighting at one of the locations given at the front of the manual.

Faults When Operational

If a fault occurs whilst the console is operational, it will help your service agent if you save your show onto a newly formatted disk (not your master show disk).

If necessary, you can send this to your agent as the error log it contains may help to isolate the fault.

Alternatively, print the error log as soon as possible after the fault occurs.

Trouble Shooting

PROBLEM: Console appears to function but no control over lights.

POSSIBLE CAUSE:

- Dimmers not switched on.
- Multiplex lead is not plugged in correctly.
- Mux protocol is incorrect.
- Blackout key is active.
- Grand Master is at zero.

PROBLEM : Console has no LCD or LED displays.

POSSIBLE CAUSE:

- Mains Power supply is not on.
- Power supply adapter plugged in incorrectly.

PROBLEM: No monitor display - Console operational.

POSSIBLE CAUSE:

- Incorrect connection to VGA port.
- Power supply to monitor is not on.

The console has no user serviceable parts and no attempt should be made to disassemble the unit for repair. Contact your Strand dealer for service information.

Error messages

Genius has a comprehensive list of messages listed in system memory which appear in the LCD, a typical example is shown below.

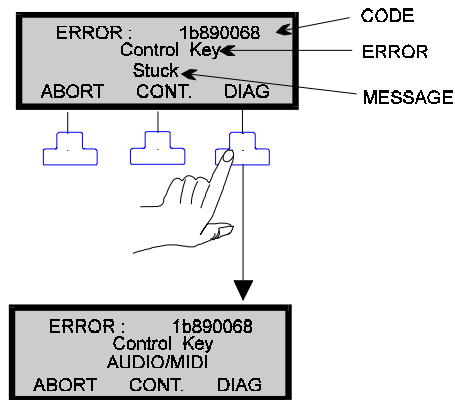

DIAG: This can often give further information about the error as in the case above which shows that the AUDIO/MIDI key is the one that is stuck. Sometimes pressing this key gives out information for service use.

ABORT /CONT These keys when pressed will continue or end testing the system. Errors will be logged and if possible the console will become usable.

Most error messages are for service use only, however messages that can be rectified or acted upon are shown in the table overleaf with suitable advice.

Contact your dealer for further information on these or any other messages that may appear.

ERROR	MESSAGE	ACTION
Bump Key	Stuck	Check bump key
Control Fader	Stuck	Check control fader
Control Key	Stuck	Check key, press DIAG to find which one
Bump Key	Buffer Full	Too many bump key changes
Control Key	Buffer Full	Too many control key changes
Fader Event	Buffer Full	Too many fader changes
Disk Directory	File Missing	Try another floppy
Disk File Header	File Bad	Try another floppy
Disk Mount	Disk Missing	Try another floppy
Hardware	Brownout	Check Power supply
Hardware	Power Fail	Power failure occurred - check supply
Voltage Ref	Battery Failure	Leave powered on for 48 hours (Check battery)
Console Software	Memory Full	No more memory
Disk Software	Disk is full	Your disk is full
Disk Software	Disk Write Protect	Write protect is on

Notes

Designers Remote

The Designers Remote unit has a 4x16 character display and duplicates some of the the facilities of the console.



Designers Remote

Connecting Up

The Designers Remote comes supplied with an attached cable terminated in a 6 pin XLR male connector. Also supplied is another 2m length cable for connecting to the RS232 port on the console.

The two cables supplied allow GSX and the remote to be integrated with the house installation system.

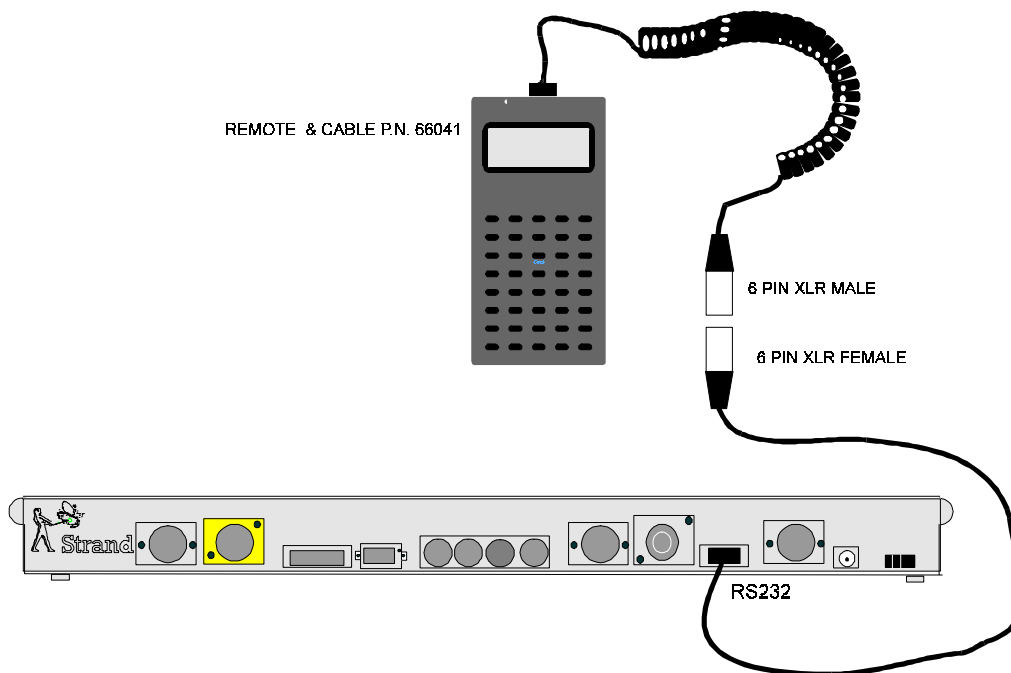

See **Appendix B** for pin-out configuration.

Notes

Designers Remote

123

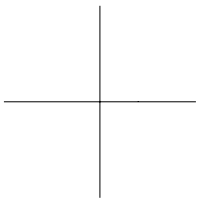
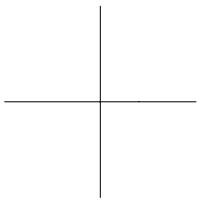

Notes

Appendix A Reference

Output Screen

The screenshot shows a control console interface with the following sections:

- Header:** 09:00:00 01 / 08 / 93 OUTPUT 200 Free cues GM = FL
- Cue Lists:**
 - 001 02 03 04 05 06 07 08 09 10 11 12 13 14 15 16 17 18 19 20 21 22 23 24 025
 - 026 27 28 29 30 31 32 33 34 35 36 37 38 39 40 41 42 43 44 45 46 47 48 49 050
 - 051 52 53 54 55 56 57 58 59 60 61 62 63 64 65 66 67 68 69 70 71 72 73 74 075
 - 076 77 78 79 80 81 82 83 84 85 86 87 88 89 90 91 92 93 94 95 96 97 98 99 100
 - 101 02 03 04 05 06 07 08 09 10 11 12 13 14 15 16 17 18 19 20 21 22 23 24 125
- Channels Window:** A box labeled "CHANNELS WINDOW" is overlaid on the cue lists, with the text "0 80 75 30" visible below it.
- X Playback Window:** A box labeled "X PLAYBACK WINDOW" is overlaid on the playback controls.
- Wheel Level:** A box labeled "WHEEL LEVEL" is overlaid on the wheel control area.
- Submasters Window:** A box labeled "SUBMASTERS WINDOW" is overlaid on the submaster controls.
- A/B Playback Window:** A box labeled "A/B PLAYBACK WINDOW" is overlaid on the A/B playback controls.
- Effects Loaded:** A box labeled "EFFECTS LOADED" is overlaid on the effects controls.
- Output Line:** A box labeled "COMMAND ENTRY LINE, WARNINGS, ERROR MESSAGES" is overlaid on the bottom of the screen.

Channel Window Colours

LEVEL COLOUR	INDICATING
GREEN	Decrease in level
BLUE	No change
MAGENTA	Increase in level
YELLOW	Under Submaster control
WHITE ON RED	Current selection
WHITE	Under A/B Playback control
YELLOW ON RED	Inhibitive submaster
RED	Last changed by channel control

Setup Screen

09:00:00 01 / 08 / 93		SETUP		200 Free cues		GM = FL	
Console							
Buzzer	OFF	ON Level %	100				
LCD Contrast %	100	Channel Control Mode	DIRECT 1 DIGIT				
LCD Backlight %	50	Effect Trigger	AUDIO, BASS, BEAT				
Power Up Macro	OFF	External Subs. Scale %	100				
Wheel Mastering	PROPORTIONAL	C / D Mode	72 x 1 SCENE PRESET				
Times							
Fade In / Up	5	X Back	0	Time Display	24HR		
Fade Out / Down	5	X Cut	0	Date Display	DD/MM/YY		
Delay Up	0	Trig Time HHMM		Set Time HHMM			
Delay Down	0	Trig Date DDMM		Set Date DDMM			
Wait	OFF	Trig Macro	OFF	Set Year YYYY			
FX Step	0.5						
Dimmer and Patch		Serial RS-232		Wheel			
Dimmer Output	DMX512	Baud Rate	9k6				
AMX Scaling %	100	Data Bits	8				
D54 Scaling %	100	Parity	NONE				
Default Scale %	100	Stop Bits	1				
Default Frame	10	Function	PRINTER				
Default N-Dim	80	Printer	ASCII OUT				
Audio Input		Paper size	A4				
Trig. Macro	OFF	Trig. Byte (s)	OFF OFF OFF				
		Trig. Macro	OFF				
MIDI							
APPL GEN 125 KAL COM F1 +0a		Mode	OFF	Trig. Bytes	OFF OFF OFF		
CONS 000 000 000 023 123 345		Channel	1	Trig. Macro	OFF		
PASSW 000 000 000 000 000 000		MSC ID	OFF				
000 000 000 000 000 000							
SETUP: *							
Select item to edit							

The following pages show the options available in this screen for both European and U.S markets.

K= KALEIDOSCOPE function

C=COMMUNIQUE function

AUDIO INPUT and MIDI options are not used in Genius and are COMMUNIQUE functions.

Console Setup Options

Setting	Option	Default Euro	Default U.S	Page Ref.
BUZZER VOLUME	0 (Off), 1, 2, 3 (Max.)	0	0	-
LCD CONTRAST %	0 -100	Off	Off	-
LCD BACKLIGHT %	0 - 100	Off	Off	-
POWER UP MACRO	Off, 0 - 9	Off	Off	-
WHEEL MASTERING	Proportional, Shaft	Proportional	Proportional	45
CHANNEL CONTROL MODE	Direct 2 Digits, Direct 1 Digit Command Line	Direct, 2 Digits	Command Line	37
ON LEVEL %	0 - 100	100	100	38
EFFECT TRIGGER	Not Used			K
DMX IN	Not Used			C
SUB FADE IN TIMES	Manual, Recorded	Manual	Manual	73
EXT. SUBS SCALE %	Not Used			C

Times Setup Options

Setting	Option	Default Euro	Default U.S	Page Ref.
FADE IN/OUT	0 - 59.9 seconds	5 / 5 seconds	5 / 5 seconds	63
FADE UP/DOWN	0 - 59.9 seconds	5 / 5 seconds	5 / 5 seconds	63
DELAY UP/DOWN	0 - 59.9 seconds	0 / 0	0 / 0	54
WAIT TIME	0 - 59.9 seconds	0	0	53
FX STEP TIME	0 - 59.9 seconds	0.1 seconds	0.1 seconds	-
X BACK TIME	0 - 59.9 seconds	0	0	66
X CUT TIME	0 - 59.9 seconds	0	0	65
TIME DISPLAY	24 Hour, AM/PM	24 Hour	AM / PM	-
DATE DISPLAY	dd/mm/yy mm/dd/yy	dd/mm/yy	mm/dd/yy	-

Dimmer & Patch Setup Options

Setting	Option	Default Euro	Default U.S	Page Ref.
DIMMER OUTPUT	DMX 512, AMX 192, D54, SMX (Europe only)	DMX	DMX	7
SMX BAUD RATE (Europe Only)	2400, 9600, 19.2k, 62.5k, 250k	250k	N/A	-
AMX SCALING %	80 - 120%	100%	100%	80
D54 SCALING %	80 -120%	100%	100%	80
DEFAULT SCALE %	0 - 200%	100%	100%	80
DEFAULT FRAME	Not Used			K
DEFAULT NON-DIM	1 - 100%	80%	80%	83

Serial RS 232 Setup Options

Setting	Option	Default Euro	Default U.S	Page Ref.
BAUD RATE	1k2, 2k4, 4k8, 9k6, 19.2k	9600	9600	-
DATA BITS	8, 7	8	8	-
PARITY	None, Odd, Even	None	None	-
STOP BITS	1, 2	1	1	-
FUNCTION	Printer, Terminal, Ascii In, Test, Off	Printer	Printer	-
PRINTER	Ascii, Epson FX, IBM Pro, HP Laser	Ascii	Ascii	6
PAPER SIZE	A4 11" x 8.5"	A4	11" x 8.5"	6
TRIG.BYTES	Off, Off Off	n/a	n/a	-
TRIG.MACRO	Off, 0 - 9	Off	Off	-

Help Key

The HELP key activates a help screen and will always over-ride the current screen giving you a snapshot of the GSX's complete operating environment. Whilst active, the LED flashes.

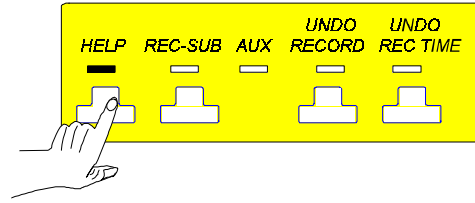

<p>09:00:00 01 / 08 / 93</p> <p>SINGLE DIGIT MODE</p> <table style="width: 100%; border-collapse: collapse;"> <tr> <td style="width: 30%;">Keys:</td> <td>Result</td> </tr> <tr> <td>5</td> <td>50%</td> </tr> <tr> <td>5.5</td> <td>55%</td> </tr> <tr> <td>05</td> <td>5%</td> </tr> <tr> <td>.5</td> <td>0.5%</td> </tr> </table> <p>THRU LISTS</p> <table style="width: 100%; border-collapse: collapse;"> <tr> <td style="width: 30%;">Keys:</td> <td>Result</td> </tr> <tr> <td>1 THRU 3</td> <td>1,2,3</td> </tr> <tr> <td>1 THRU 3 + 5</td> <td>1,2,3,5</td> </tr> <tr> <td>1 THRU 3 - 2</td> <td>1,3</td> </tr> </table> <p>COMMAND MODE RECORD</p> <p>Crossfade cues: RECORD CUE 1 *</p> <p>Movefade cues: RECORD CUE + 1 *</p> <p>DIRECT MODE RECORD</p> <p>CUE 1 RECORD CUE + 1 RECORD</p> <p>PATCH</p> <p>Level dimmers: Dim @ chan @ proportion</p> <p>Colour scrollers : Dim @ COL chan @COL frame</p> <p>Non-dim dimmers : Dim @NON Chan @NON Threshold</p> <p>HELP *</p>	Keys:	Result	5	50%	5.5	55%	05	5%	.5	0.5%	Keys:	Result	1 THRU 3	1,2,3	1 THRU 3 + 5	1,2,3,5	1 THRU 3 - 2	1,3	<p style="text-align: center;">HELP</p> <p>Press DISPLAY to select:</p> <p>OUTPUT menu MEMORY menu UTILITIES menu SYSTEM menu</p> <p>Press F1, F2, F3 for options. Press DISPLAY to get back.</p> <p>MEMORY Cues, Subs, Fx CUES Xref, Renum, Delete XREF <, > SUBS Clear FX Effects, Step, Clear UTILITIES Patch, Macro, Archive PATCH Default, Set, @NON SET Order, Live=, Edit= MACRO F1, F2, F3 ARCHIVE Disk, Print, Clear DISK Load, Soft, Format SOFT Oper, Appl, Passw OPER Load APPL Load PASSW Enter PRINT Print, Stop CLEAR Clear SYSTEM Setup, Log, Lock= SETUP Default, Sync, Test TEST Loadsw, Utils, Select</p>	<p style="text-align: right;">195 Free cues GM = FL</p> <p>PRESET MACROS</p> <p>Press MACRO then:</p> <table style="width: 100%; border-collapse: collapse;"> <tr> <td>@</td> <td>Undo @</td> </tr> <tr> <td>@COL</td> <td>Undo @COL</td> </tr> <tr> <td>CLR</td> <td>Clr command</td> </tr> <tr> <td>CUE</td> <td>Update cue</td> </tr> <tr> <td>DISPLAY</td> <td>OUTPUT menu</td> </tr> <tr> <td>FX</td> <td>Update FX</td> </tr> <tr> <td>LAST</td> <td>Last Command</td> </tr> <tr> <td>LOADA</td> <td>Update from A</td> </tr> <tr> <td>LOADB</td> <td>Update from B</td> </tr> <tr> <td>LOADX</td> <td>Update from X</td> </tr> <tr> <td>MACRO</td> <td>Cancel MACRO</td> </tr> <tr> <td>ON</td> <td>@ Full</td> </tr> <tr> <td>REC</td> <td>Undo REC</td> </tr> <tr> <td>RECTIME</td> <td>Undo RECTIME</td> </tr> <tr> <td>SUB</td> <td>Update Sub</td> </tr> <tr> <td>THRU</td> <td>THRU on</td> </tr> <tr> <td>+</td> <td>Solo toggle</td> </tr> <tr> <td>-</td> <td>Remainder dim</td> </tr> </table> <p>Press MACRO with: BUMP Bump 1-12</p> <p>DISPLAY SHORTCUTS</p> <p>CUE n DISPLAY To Cue SUB n DISPLAY To Sub FX m, n DISPLAY To FX</p>	@	Undo @	@COL	Undo @COL	CLR	Clr command	CUE	Update cue	DISPLAY	OUTPUT menu	FX	Update FX	LAST	Last Command	LOADA	Update from A	LOADB	Update from B	LOADX	Update from X	MACRO	Cancel MACRO	ON	@ Full	REC	Undo REC	RECTIME	Undo RECTIME	SUB	Update Sub	THRU	THRU on	+	Solo toggle	-	Remainder dim
Keys:	Result																																																							
5	50%																																																							
5.5	55%																																																							
05	5%																																																							
.5	0.5%																																																							
Keys:	Result																																																							
1 THRU 3	1,2,3																																																							
1 THRU 3 + 5	1,2,3,5																																																							
1 THRU 3 - 2	1,3																																																							
@	Undo @																																																							
@COL	Undo @COL																																																							
CLR	Clr command																																																							
CUE	Update cue																																																							
DISPLAY	OUTPUT menu																																																							
FX	Update FX																																																							
LAST	Last Command																																																							
LOADA	Update from A																																																							
LOADB	Update from B																																																							
LOADX	Update from X																																																							
MACRO	Cancel MACRO																																																							
ON	@ Full																																																							
REC	Undo REC																																																							
RECTIME	Undo RECTIME																																																							
SUB	Update Sub																																																							
THRU	THRU on																																																							
+	Solo toggle																																																							
-	Remainder dim																																																							

To cancel HELP press CLR or *

Aux LED

This has no function at this time and is for future development.

Menu/Screen Flow Chart

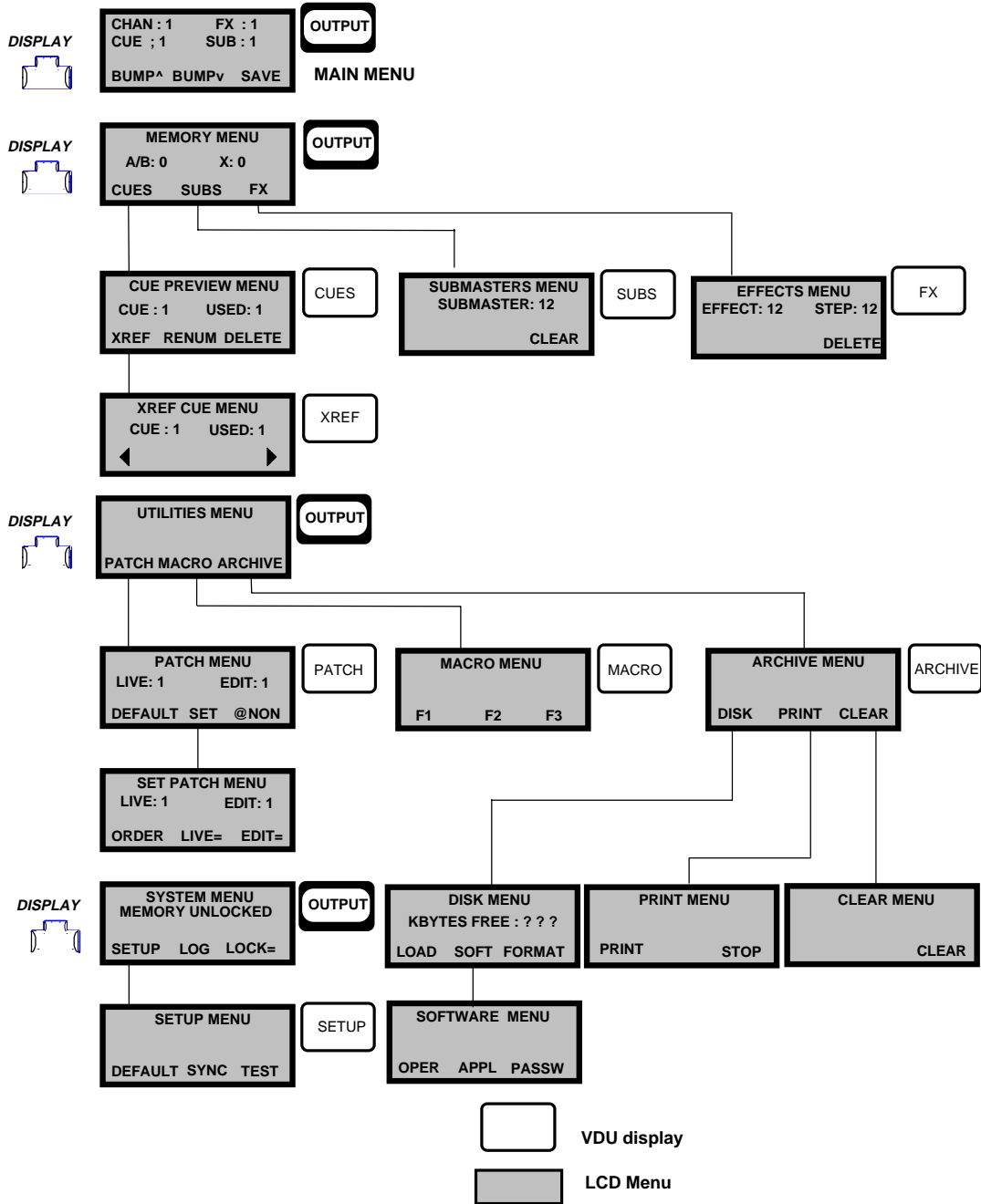

Command Descriptions

CHANNEL CONTROL - General

COMMAND LINE mode always requires * to be entered. in order to complete the command. Where COMMAND LINE entries differ they are shown in italics

1 ON	Channel 1 to current ON level (default is FL)
NEXT ON	Channel 2 to ON level
LAST ON	Channel 1 to ON level
3 @FULL [MACRO ON]	Channel 3 to 100%
1 *	Channel 1 becomes the current selection
1 > 5 ON	Channels 1..5 to ON level
5 > 1 ON	Ditto
1 > 5 + 7 > 9 ON	Channels 1..5 and 7..9 to ON level
1 > 5 - 3 ON	Channels 1, 2, 4 and 5 to ON level
CUE 1 @FULL	Channels in cue 1 to their recorded levels
CUE 1 @ *	Ditto
CUE 1 *	Channels in cue 1 become the current selection
CUE 1 > 2 @ *	HTP sum of recorded Channels in cues 1 and 2
1 <wheel>	Channel 1 is wheeled
NEXT <wheel>	Channel 2 is wheeled
CUE 1 <wheel>	Channels in cue 1 are wheeled from current levels
1 REMDIM	All Channels except 1 are set to off

1 SOLO	Channel 1 is soloed (most keys now locked out)
SOLO	Channel 1 is unsoloed (all keys enabled)
1 BUMP UP [F1]	Channel 1 is flashed to 100%
BUMP DOWN [F2]]	Channel 1 is returned (all keys enabled)
UNDO@	Channels before the last @ are restored
CLR	Command line empty: clear current selection
CLR	Command line not empty: clear last key

CHANNEL CONTROL - Single Digit Mode

1 @ 1	Channel 1 to 10%
1 @ 1.1	Channel 1 to 11%
1 @ 0.1	Channel 1 to 1%
1 @ 0	Channel 1 on at 0%
1 @ .	Channel 1 off
1 @ + 2	Channel 1 up by 20%
1 @ - 1.1	Channel 1 down by 11%
CUE 1 @ 2	Channels in cue 1 at 20% of recorded levels
CUE 1 @ + 2	Channels in cue 1 at 120% of recorded levels
CUE 1 @ - 2	Channels in cue 1 at 80% of recorded levels
1 + CUE 1 @ 2	Channels in cue 1 at 20% of recorded levels, plus Channel 1 at 20%, whether or not it is used in cue 1.

CHANNEL CONTROL - Double Digit Mode

1 @ 10	Channel 1 to 10%
1 @ 11	Channel 1 to 11%
1 @ 01	Channel 1 to 1%
1 @ 00	Channel 1 on at 0%
1 @ .	Channel 1 off
1 @ + 20	Channel 1 up by 20%
1 @ - 11	Channel 1 down by 11%
CUE 1 @ 20	Channels in cue 1 at 20% of recorded levels
CUE 1 @ + 20	Channels in cue 1 at 120% of recorded levels
CUE 1 @ - 20	Channels in cue 1 at 80% of recorded levels
1 + CUE 1 @ 20	Channels in cue 1 at 20% of recorded levels, plus Channel 1 at 20%, whether or not it is used in cue 1.

RECORDING CUES

CUE 1 RECORD <i>RECORD CUE 1 *</i>	Records output Channels and Channels to cue 1,using default times if cue 1 does not exist, or keeping recorded times if it does.
CUE RECORD <i>RECORD CUE *</i>	Records the currently selected cue
RECORD	Ditto
CUE + 1 RECORD <i>RECORD CUE+1 *</i>	Records cue 1 as a move fade
CUE 1 TIME 4 RECORD <i>RECORD CUE 1 TIME 4 *</i>	Records cue 1 with up/down fade times of 4s
CUE 1 TIME 4.1 RECORD <i>RECORD CUE 1 TIME 4.1*</i>	of 4.1s
CUE 1 TIME 41 RECORD <i>RECORD CUE 1 TIME 41 *</i>	of 41s
CUE 1 TIME 412 RECORD <i>RECORD CUE 1 TIME 412 *</i>	of 4m 12s
CUE 1 TIME 4123 RECORD <i>RECORD CUE 1 TIME 4123 *</i>	of 41m 23s
CUE 1 TIME 6 RECTIME <i>RECTIME CUE 1 TIME 6</i>	Records cue 1 times only, not Channels
At cue sheet with cue 1 selected: CUE 2 COPY <i>COPY CUE 2 *</i>	Cue 1 is copied to cue 2
At cue sheet with the selection bar on a cue number: DELETECUE [F3]	Deletes selected cue
CUE 2 DELETECUE	Delete cue 2 if present
CUE 1.1 > 1.3 DELETECUE	Delete cues 1.1, 1.2 and 1.3 if present

UPDATING CUES

1 UPDATECUE 1 RECORD
*1 RECORD UPDATE CUE 1 ** Channel 1 is added to cue 1

UPDATECUE RECORD
*RECORD UPDATECUE ** Same as RECORD, if there is no current selection

6 > 8 UPDATECUE RECORD
*6 > 8 RECORD UPDATECUE ** Channels 6..8 are added to in the current cue

CUE 1 UPDATECUE 2 RECORD
CUE 1 RECORD UPDATE CUE 2 Cue ones recorded
Channels are added to cue 2

*In COMMAND LINE mode, cues can be recorded without the word CUE if desired e.g. RECORD 1 TIME 4 < * >*

RECORDING SUBMASTERS

SUB 1 RECORD
*RECORD SUB 1 ** Records all Channel with levels in Output screen as Submaster 1.

SUB BUMP
Records the submaster whose bump key was pressed.

BUMP
Bumps the Channels in the selected submaster to FL

BUMP
Returns the Channels to their previous levels. This is a second bump press if latched or the first bump press if released.

LCD AND DISPLAY COMMANDS

CUE 1 DISPLAY	Go to the cue sheet, select cue
CUE DISPLAY	Go to the cue sheet, at previous selection
OUTPUT [MACRO DISPLAY]	Return to main output display from any other

At submasters display (selection bar on a submaster No.)

CLEARSUB [F3]	Clear selected submaster
1 CLEARSUB	Clear submaster 1
1 > 3 CLEARSUB	Clear submasters 1..3

Editing Screen Fields

Method	Numeric field:	Symbolic field:
Type at keypad	Yes	No
NEXT, LAST, +, -	Yes	Yes
Wheel [also PageUp/Down]	Yes	Yes
CLR	Restores the field to the value when it was selected, or delete the last key typed.	
DEFAULT [F1]	Restores the field to its factory default setting. (Setup screen only).	

Appendix B - Connectors / Pin-out tables

Power Connector

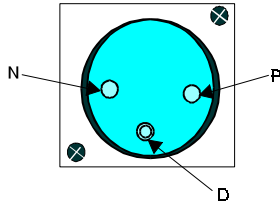

3 pin male AXR

Pin	Description
D	Drain -GND chassis
P	Positive
N	Negative

DMX512 OUT SMX(Europe only))

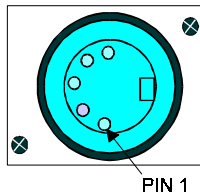

5 pin female XLR

Pin	Description
Pin 1	Data GND
Pin 2	Data signal -
Pin 3	Data signal +
Pin 4	No connection
Pin 5	No connection

AMX192

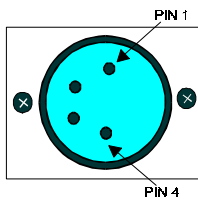

4 pin male XLR

Pin	Description
Pin 1	Screen (Analogue 0V)
Pin 2	Clock +
Pin 3	Analogue multiplex
Pin 4	Clock -

D54

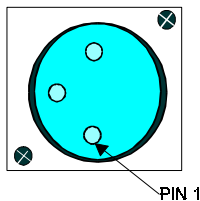

3 pin female XLR

Pin	Description
Pin 1	Screen (Analogue 0v)
Pin 2	No connection
Pin 3	Analogue multiplex

RS 232

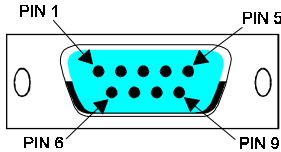

RS-232 Serial (Printer, Remote & ASCII Input) 9 pin male D-type. Any 'AUTO LF' dip-switches must be disabled.

Pin	Description
Pin 1	Power GND
Pin 2	RX signal
Pin 3	TX signal
Pin 4	No connection
Pin 5	GND signal
Pin 6	10V Power
Pin 7	No connection
Pin 8	No connection
Pin 9	No connection

VGA

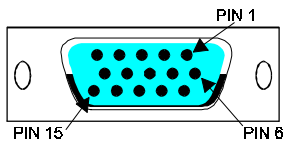

15 pin High Density female DB-15, IBM PS/2

Pin	Description
Pin 1	Analog Red 0-0.7V
Pin 2	Analog Green 0-0.7V
Pin 3	Analog Blue 0-0.7V
Pin 4	No connection
Pin 5	GND
Pin 6	Red GND
Pin 7	Green GND
Pin 8	Blue GND
Pin 9	No connection
Pin 10	GND
Pin 11	No Connection
Pin 12	No connection
Pin 13	Hsync. (TTL)
Pin 14	Vsync. (TTL)
Pin 15	No connection

Screen Format:- 640 x 480 pixel resolution -
16 cols. 80 x 34 lines TEXT MODE ONLY

Audio input

5 pin female DIN- type 180

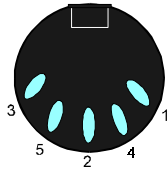

Pin	Description
Pin 1	No connection
Pin 2	Signal GND
Pin 3	Audio in (L. channel)
Pin 4	No connection
Pin 5	Audio in (R. channel)

Designers Remote

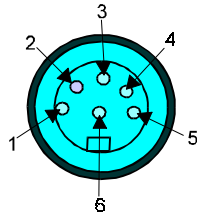

6 pin female XLR

Pin	Description
Pin 1	Screen GND
Pin 2	+10V
Pin 3	Data + 485
Pin 4	Data - 485
Pin 5	232 Rx
Pin 6	232 Tx

Notes

Index

+, - Keys 39

A

@, 38
@FULL, 38
Application Software, 9
 Loading, 13
Archive menu / Screen, 99
Auto Hold, 107

B

Backing Up Software, 16
Blackout key, 69
Bump keys, 71

C

Clearing down memories, 100
CLR, 40
Cold Start, 10
Combination Entries, 39
Cues,
 automatic operation, 53
 blind editing, 56
 copying, 59
 cross referencing, 62
 cue sheet, 56
 decimal point, 48
 deleting, 61
 editing, 56
 F1, F2, F3 keys, 49
 maximum allowed, 48
 modifying levels -, 58
 recording, 48
 recording empty one, 55
 recording with time, 49
 renumbering, 60
 scrolling, 57
Current Selection, 41
CUT, 65

Index

D

DELAY, 54
Disk
 formatting, 103
 loading from, 102
 menu, 102
 saving to, 44
DOUBLE DIGIT mode, 37

E

Effects
 changing whilst running, 89
 deleting, 91
 direction, 89
 effect sheet, 87
 loading, 88
 master fader, 91
 recording, 85
 running, 88
 stopping, 89
 tips for setting chases, 92
 updating, 90
Error log, 115
Error messages, 118

F

Fades
 C/D fade times, 113
 crossfade, 50
 fade down 52
 fade in, 52
 fade out, 52
 fade up, 52
 fade times, 49
 movefade, 51
 running fades together, 69
Faultfinding, 116
Flash
 C/D, flash 113
 flash controls, 75

G

Getting Started

- displays and how to get to them, 23
- entering channels, 25
- key descriptions, 22
- playing back cues, 30
- recording a cue, 27
- running the effect, 35
- saving a show, 36
- using submasters, 31
- wheel and cursor keys, 23

GO, 64

Grand master, 69

I

Invalid key entries, 40

L

LBX Operating Modes

- 36x2 scene preset, 110
- 48x2 scene preset, 112
- 72x1 scene preset, 106
- 96x1 scene preset, 111

LAST, 40

Links, 59

LOAD A/B, 67

LOAD X, 65

Loading shows, 102

Loops, 59

M

Macros

- built-in, 93
- power up macro, 98
- recording, 95
- triggering from Submasters, 78
- triggering user macros, 98
- user examples, 96

MACRO CLR, 40

MACRO CUE, 52

MACRO THRU, 39

MACRO +, 43

MACRO -, 43

MACRO THRU, 39

MACRO @, 40

MACRO FX, 90

MACRO SUB, 76

MACRO ON, 38

MACRO DISPLAY, 36

MAN TIME, 65

MAN TIME/SEQ, 68

mux sockets, 7

N

NEXT, 40

Non dims, 83

O

ON, 38

Operating Software, 9

 Loading / Updating, 11

P

Password entry, 15

Patch

- default, 81
- live, 82
- order, 82
- patching dimmers, 83
- patching non-dims, 83
- preview patch, 82
- set patch menu, 82
- unpatching, 83

Playbacks

- automatic (X), 64
- manual (A/B), 67
- sequences, 68
- with recorded time, 68
- with manual time, 68

Power input socket, 5

Preset Masters (C/D), 108

Printer types, 6

Printing, 101

Proportional mastering, 45

R

RATE, 65
REC TIME, 49
RECORD, 48
Remote control, 121
RS232 port, 6

S

Scaling, 80
Screen colours, 125
Setting up blind scenes, 107
Shaft mastering, 45
SHIFT key, (LBX), 113
Single digit mode, 37
SPLIT (/), 53
Stealing Channels, 114
STOP/BACK, 66
Submasters
 clearing, 75
 editing, 75
 inhibitive, 76
 recording, 72
 recording with time, 73
 triggering macros, 77
 updating, 76

T

THRU, 39

U

UNDO @, 40
Upgrading Software, 16

V

VGA port, 5

W

WAIT, 53
Warm start, 10

User Macro Table

NO.	DESCRIPTION
0	
1	
2	
3	
4	
5	
6	
7	
8	
9	

Notes

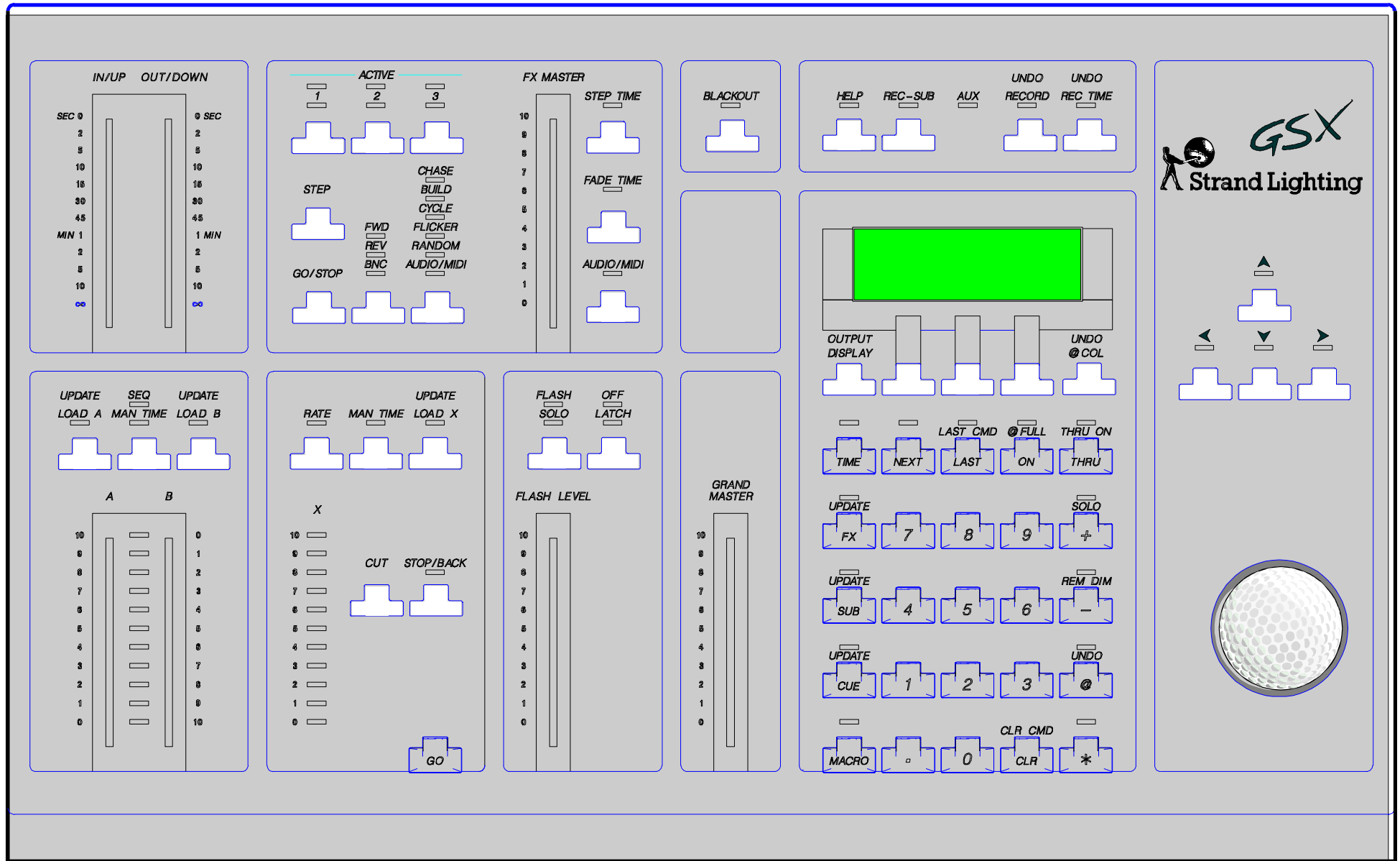

GSX PANEL LAYOUT

IN/UP OUT/DOWN

SEC 0 2 5 10 15 30 45 1 MIN

MIN 1 2 5 10 100 ∞

IN/UP OUT/DOWN

SEC 0 2 5 10 15 30 45 1 MIN

MIN 1 2 5 10 100 ∞

ACTIVE

1 2 3

STEP

CHASE BUILD CYCLE FLICKER RANDOM AUDIO/MIDI

FWD REV BNG

GO/STOP

UPDATE SEQ UPDATE LOAD A MAN TIME LOAD B

A B

10 9 8 7 6 5 4 3 2 1 0

10 9 8 7 6 5 4 3 2 1 0

UPDATE RATE MAN TIME LOAD X

UPDATE

CUT STOP/BACK

X

10 9 8 7 6 5 4 3 2 1 0

GO

IN OUT

SEC 0 2 5 10 15 30 45 1 MIN

MIN 1 2 5 10 100 ∞

IN/UP OUT/DOWN

SEC 0 2 5 10 15 30 45 1 MIN

MIN 1 2 5 10 100 ∞

ACTIVE

1 2 3

STEP

CHASE BUILD CYCLE FLICKER RANDOM AUDIO/MIDI

FWD REV BNG

GO/STOP

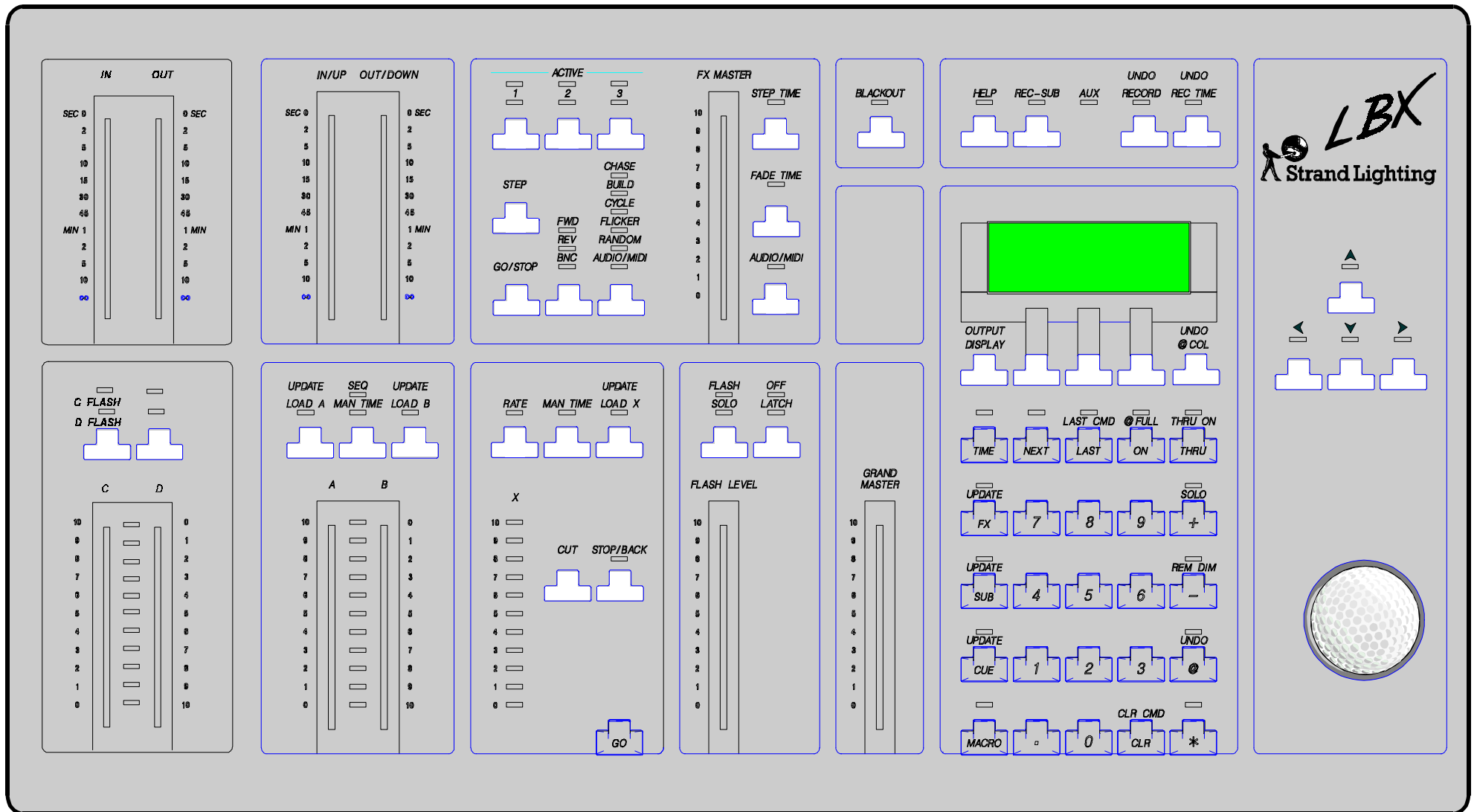

LBX Panel Layout